

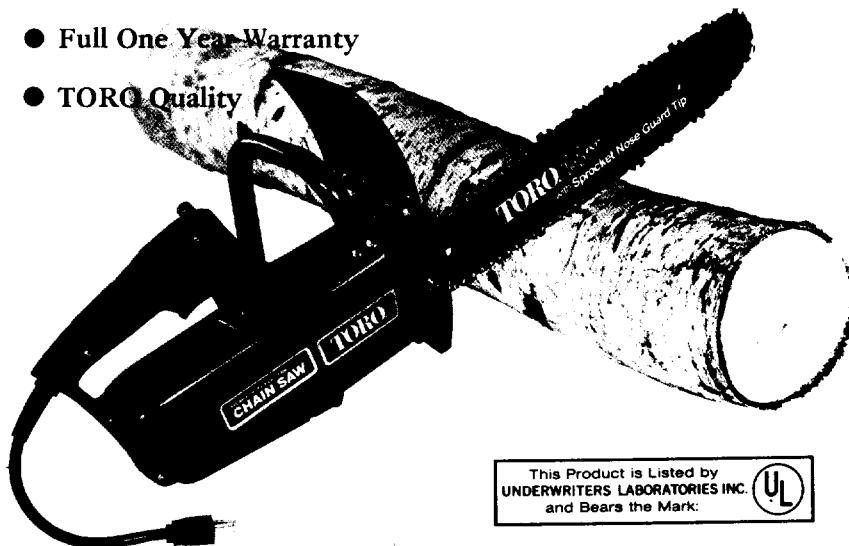



Compact Electric Chain Saw 14"

- In Line Design for Better Balance
- Non Symmetrical Guide Bar for Reduced Kickback
- Lightweight for Easy Handling
- Heavy Duty Motor
- Protective Hand Guard
- Full One Year Warranty
- TORO Quality



This Product is Listed by
UNDERWRITERS LABORATORIES INC.
and Bears the Mark: 

Haven't you done without a Toro long enough?®



WELCOME to the TORO® family of fine lawn and garden equipment. Your TORO ELECTRIC CHAIN SAW features advanced concepts in engineering design and safety. This Operator's Manual has been designed to help you thoroughly understand your new tool before using it. Please read it completely before operating the tool. You will find that as your knowledge of the tool increases, your proficiency with it will improve.

⚠ Pay particular attention to the instructions highlighted by this safety alert symbol. Failure to comply with the safety instructions may result in personal injury. Safety, mechanical, and some general information in this manual is emphasized. DANGER, WARNING, and CAUTION identify the safety messages. IMPORTANT identifies special mechanical information and NOTE identifies general information worthy of special attention.



TORO COMPACT 14" CHAIN SAW MODEL 51140

OPERATOR'S MANUAL

 **Safety Instructions**



To assure optimum performance, and to gain knowledge of the Chain Saw, it is essential that you or any other operator of the Chain Saw read and understand the contents of this manual before operating Chain Saw. Pay particular attention to the instructions highlighted by the safety alert symbol. Failure to comply with the safety instructions may result in personal injury.

1. **READ OPERATOR'S MANUAL CAREFULLY.** Become fully familiar with the chain saw before attempting to operate it.
2. **KEEP WORK AREA CLEAN.** Cluttered areas and benches invite accidents.
3. **AVOID DANGEROUS ENVIRONMENT.** Don't expose saw to rain, or use saw in damp or wet locations. Keep work area well lit. **NEVER OPERATE THE SAW WHILE IN CONTACT WITH WATER.**
4. **WEAR PROPER APPAREL.** Loose clothing or jewelry may get caught in moving parts. Wear a hard hat during felling of trees.
5. **WEAR SAFETY GLASSES.** Use safety glasses with most tools. Also use a face or dust mask if cutting operation is dusty.
6. **KEEP CHILDREN AWAY.** All visitors should be kept a safe distance from work area.
7. **NEVER OPERATE SAW WHEN YOU ARE FATIGUED.**
8. **USE PROPER EXTENSION CORD OUTDOORS.** When tool is used outdoors, use only extension cords suitable for use outdoors and so marked. (Suggested cord sizes listed on page 5.)
9. **MAINTAIN SAW WITH CARE.** Never operate a chain saw that is unclean, improperly adjusted, or is not completely and securely assembled. Keep the saw handles dry, clean and free of oil. Use only identical replacement parts. Follow instructions for lubricating and changing accessories.
10. **REMOVE ADJUSTING TOOLS.** Form habit of checking to see that adjusting tools are removed from tool before turning it on.
11. **DISCONNECT SAW WHEN NOT IN USE.** Disconnect before servicing and when changing accessories such as guide bar or saw chain.
12. **KEEP GUARDS IN PLACE AND IN WORKING ORDER.**
13. **USE CORRECT SAW.** Don't force small saw or attachment to do the job of a heavy-duty saw.
14.  **BE AWARE OF KICKBACK.** When the moving chain at the nose of the guide bar touches an object, the chain and guide bar often are thrown upward with speed and force, (see figure 12).
Your TORO chain saw's special non-symmetrical guide bar reduces this action, but care must be taken regardless.
15. **SECURE WORK.** Use clamps or chocks to secure work.

 **Safety Instructions (cont.)**

16. CONNECT CHAIN SAW TO CORRECT VOLTAGE (120V).

17. AVOID ACCIDENTAL STARTING. Do not place finger on switch when plugging in or until ready for cutting. Always carry the chain saw from one location to another with the power cord disconnected and finger off of switch. The guide bar and saw chain should be to the rear, and away from your body (see figure 12).

18. BETWEEN CUTS set the saw down and pick it back up by the front handle to avoid contacting switch and starting saw unintentionally.

19. GRIP SAW PROPERLY. Always hold the chain saw firmly with both hands when the saw is running. Use a firm grip with thumbs and all fingers encircling the chain saw handles.

20. DON'T OVERREACH. Keep proper footing and balance at all times.

21. KEEP HANDS AWAY FROM CUTTING AREA. Be sure all parts of your body or clothing are away from the cutting area before starting the saw and during its operation.

22. DON'T ABUSE CORD. Never carry tool by cord or yank it to disconnect from receptacle. Keep cord away from heat, oil, sharp edges and away from operator.

23. CLEAR SAW CHAIN BEFORE STARTING. Before you start the saw, make sure the saw chain is not contacting operator.

24. DON'T FORCE SAW. It will do the job better and safer at the rate for which it was designed.

25. STORE IDLE SAW. When not in use, saw should be stored in dry, high, or locked-up place – out of reach of children.

26. BE ALERT WHEN CUTTING LIMBS. When cutting a limb that is under tension be alert for spring back so that you will not be struck when the tension in the wood fibers is released.

27. USE CAUTION WHEN CUTTING BRUSH AND SAPLINGS. Slender brush and saplings may catch the saw chain and be whipped toward you or pull you off balance.

28. BE CAREFUL WHEN CUTTING TREES. Do not operate a chain saw in a tree unless specifically trained to do so. When felling trees never start cutting until you have a clear work area, secure footing, and a planned retreat path.

29. CUTTING STANDING TREES REQUIRES EXPERTISE AND POSES HAZARDS. Your Toro Chain Saw should not be used to fell large trees with diameters greater than the length of your guide bar.

Assembly Instructions

Install Guide Bar and Saw Chain

1. Remove the guide bar hexagon nut and spring washer. Then remove sprocket cover (Fig. 1).

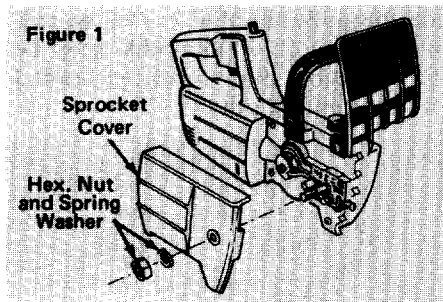

2. Loosen the guide bar adjusting block by turning the tension adjusting screw counter clockwise to the screw end (Fig. 2).

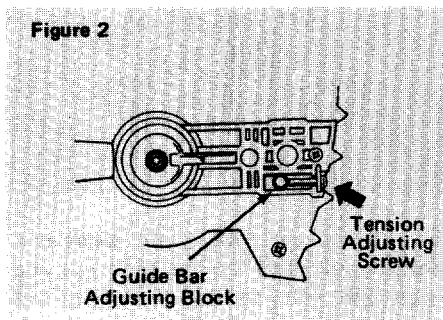

3. Insert the saw chain into the groove of the guide bar with the cutting edge facing forward toward the nose of the guide bar (see inset). Note that the through hole near the guide bar slot

must be positioned below the slot as indicated (Fig. 3).

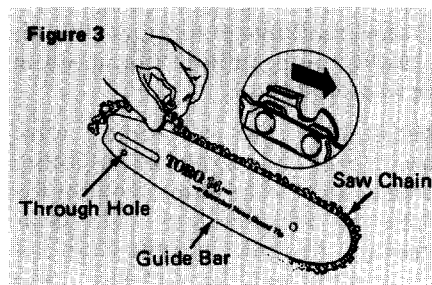

4. Loop the open end of the saw chain around the sprocket and position the guide bar slot over the guide bar bolt and guide bar pin so that the projected portion of the adjusting block fits into the through hole (Fig. 4).

⚠ NOTE: GUIDE BAR IS NOT REVERSIBLE.

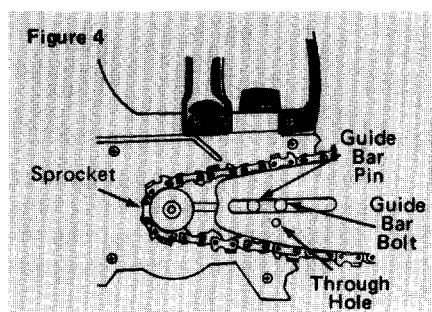

5. Replace the sprocket cover, spring washer and guide bar hexagon nut. Secure finger tight.

Assembly Instructions (cont.)

Adjust Saw Chain Tension

⚠ CAUTION: Make sure chain saw is disconnected from power source before adjusting chain tension. Use gloves or rag to protect hands.

IMPORTANT: Do not operate chain saw if chain is not properly adjusted. A loose chain will shorten sprocket and guide bar life and may cause chain breakage. An over-tightened chain will overheat the guide bar and chain, causing rapid wear and may cause motor burnout.

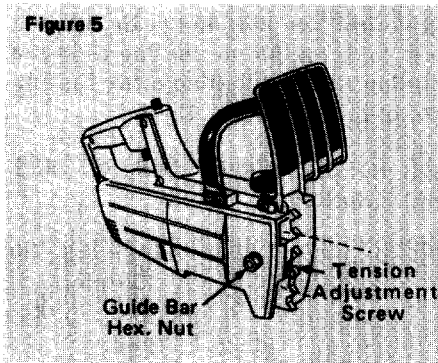

1. Loosen the guide bar hexagon nut by turning counter clockwise 1/2 turn. Then tension the chain by turning the tension adjustment screw clockwise (Fig. 5).

2. The tension is correct when the chain fits tightly but can be moved easily around the guide bar by hand.

An easy test for correct tension is to lift one chain cutter away from the middle of the guide bar (Fig. 6). There should be approximately 1/8" clearance between the bottom of the side links and the guide bar (Fig. 7). The bottom of the chain drive link should never be loose enough to drop or be pulled beyond the lip of the bar slot.

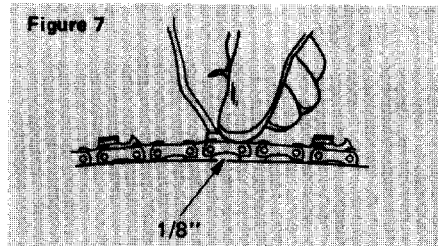
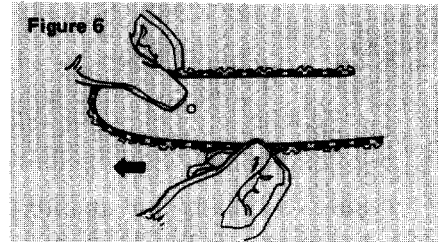

3. Lift up the nose of the guide bar, tighten the guide bar hexagon nut and *retest* the chain tension. If tension has changed, repeat entire procedure.

NOTE: Check chain tension after the first few cuts. New chains usually stretch and will require readjustment.

Before Operating

Fill Oil Reservoir

⚠ CAUTION: Make sure chain saw is disconnected from power source before performing maintenance operations.

1. Remove the oil fill cap (Fig. 8).

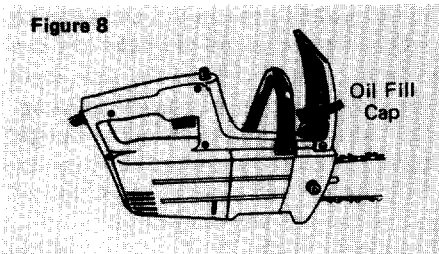

2. Using a pouring spout or funnel, fill the oil reservoir. When temperature is below 30° Fahrenheit (1° C) use SAE #10 motor oil. For temperatures above 30°F (1°C) use SAE #30 motor oil.
3. Replace and tighten fill cap immediately after filling. Failure to tighten the cap will cause excessive oil leakage. Due to the vacuum type oiling system there may be a constant minimal leakage.

IMPORTANT: Cutting without proper oiling will damage the saw's chain and bar.

Extension Cords

1. The proper extension cord is a must for safe and efficient use of your chain saw. Your extension cord should be suitable for outdoor use and comply with the requirements specified in the National Electric Code. Refer to the following table for proper extension cord usage. Examine the extension cord periodically and replace immediately if damaged.

Extension Cord Length in Feet	0-50	50-100	100-150
Required wire size (A.W.G.) in cord	16	14	12

2. Connect extension cord as shown in figure 9.

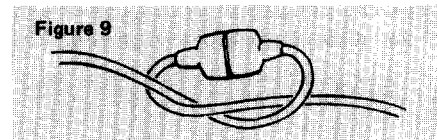

Operating Instructions

⚠ CAUTION: Operating a chain saw may be hazardous. Read and follow operating instructions carefully to help avoid possible personal injury.

1. Operate the chain saw with two hands. Use a firm grip with your fingers encircling both chain saw handles.
2. Stand to the left of the saw (Fig. 10) with your left hand on the front handle; hold the rear handle with your right

hand so you can operate the switch trigger with your right index finger.

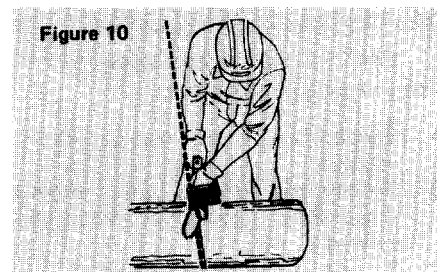

Operating Instructions (cont.)

Never stand directly behind the chain saw (Fig. 12).

3. Stand securely with your weight evenly distributed on both feet.

4. Don't overreach. Keep yourself balanced.

5. Always cut with the spike bar set firmly against the wood. Start saw chain before cutting into wood (Fig. 11).

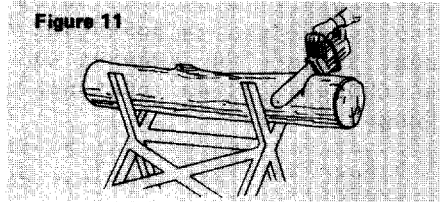

6. When cutting, keep the nose of the guide bar from contacting logs, branches, the ground or any other obstruction. This can cause **KICKBACK**, which is a quick and dangerous upward movement of the guide bar and saw chain (Fig.12)!

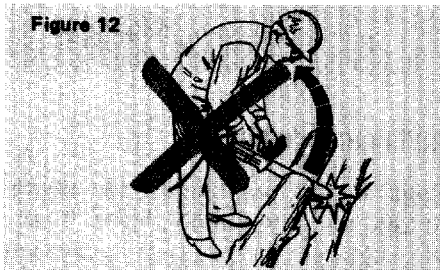

7. **IMPORTANT:** Motor overload and burnout can be caused by:

- A. Starting saw while chain is pinched in a cut.
- B. Forcing the saw into a cut so hard that chain speed is drastically slowed.
- C. Working with a saw chain that is dull

or improperly sharpened or a chain that is too tight.

- D. Using an unsuitable extension cord.
- E. Using a saw with dirty, dusty, clogged air passages. Good air circulation is necessary to properly cool the motor.

8. By pushing the oiling button with moderate pressure, oil will feed into the guide bar slot and onto the saw chain (Fig. 13). To keep the saw chain properly lubricated, push the oiling button at least once before each cut and regularly during extended cuts. Check the oil level in the reservoir frequently.

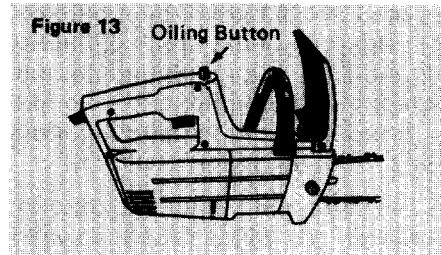

IMPORTANT: Cutting without proper oiling will damage the saw's chain and bar.

9. Before carrying the saw from one location to another disconnect the extension cord. Carry the saw with the guide bar and saw chain to the rear and away from your body (Fig. 14).

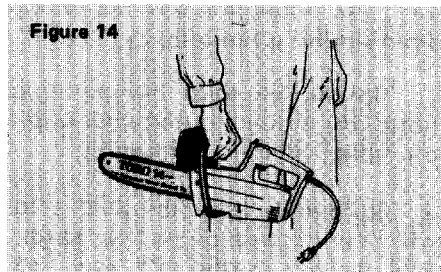

Operating Instructions (cont.)

Felling a Tree

⚠ CAUTION: Cutting standing trees requires expertise and poses hazards. Your TORO Chain Saw should not be used to fell large trees with diameters greater than the length of your guide bar.

The proper operator stance for felling a tree is shown in Figure 15.

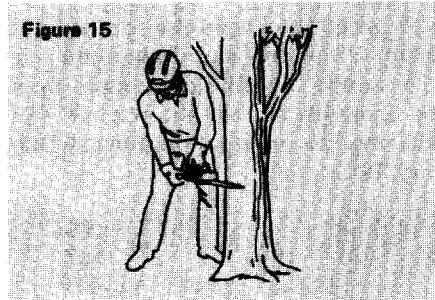

1. Before attempting to cut a big tree, practice cut a few branches, limbs or small logs to familiarize yourself with the controls.
2. Next, the direction of the fall must be determined. Consider the wind direction, if there are heavier limbs on any one side of the tree and the tree's natural tilt, if any.
3. Have a wide path cleared *behind* the planned direction of fall as a safety retreat.
4. To fell the tree, make the first cut 1/3 of the way through tree diameter on the side you want the tree to fall. The second cut should be made as illustrated to complete the notch (Fig. 16).
5. The third cut should be made from

the opposite side of the first two cuts and two or three inches higher than the bottom of the notch as shown in Figure 16.

6. Stop the third cut one or two inches from the notch to form a "hinge" which will keep the tree from falling in the wrong direction or twisting as it falls.

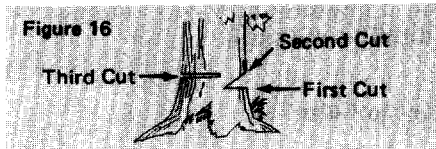

Limbing a Tree

⚠ CAUTION: When cutting limbs from a standing tree, use a well secured ladder to reach the higher areas. After you have a firm position on the ladder, hoist the chain saw with a rope. Do not climb on limbs or branches with the chain saw and don't overreach. Cut with both hands on the saw.

1. Make the first cut from the underside of the limb about 1/2 foot from the trunk. Cut one third of the way through the limb (Fig. 17).

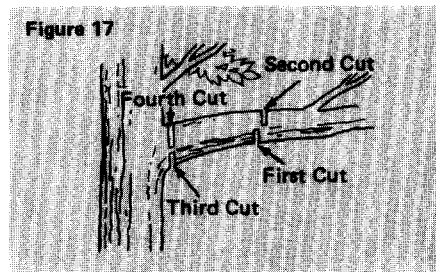

Operating Instructions (cont.)

2. Make the second cut two to four inches farther out on the limb and from above. Cut until the limb falls.
3. Cut one third the diameter of the limb stub from underneath as close to the trunk as possible.
4. Make the final cut from above so that it meets the previous cut as close as possible to the trunk.

Cutting Fallen Trees (Bucking)

1. When cutting branches from a fallen tree or cutting a log into lengths, support the log off the ground (preferably on a sawbuck).
2. When cutting a log supported on one end, cut from the top. If the chain saw should bind in the cut, never try to free it by running the motor. Stop the chain saw, then use a wedge to pry open the cut and release the saw (Fig. 18).

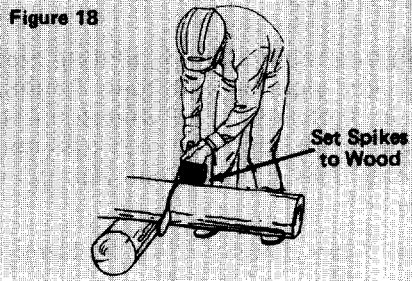

3. When cutting a log supported on both ends, start from the top and cut about 1/3 of the way through the log. The second cut should be made from the underside to meet the first cut. This will keep the log from pinching the saw (Fig. 19).

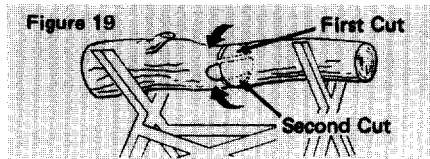

Maintenance

Refilling Oil Reservoir

⚠ CAUTION: Make sure chain saw is disconnected from power source before performing maintenance operations.

1. Remove the oil fill cap (Fig. 20).



2. Using a pouring spout or funnel, fill the oil reservoir. When temperature is below 30° Fahrenheit use SAE #10 motor oil. For temperatures above 30° use SAE #30 motor oil.

3. Replace and tighten fill cap immediately after filling. Failure to tighten the cap will cause excessive oil leakage. Due to the vacuum type oiling system there may be a constant minimal leakage.

IMPORTANT: Cutting without proper oiling will damage the saw's chain and bar.

Sharpening the Saw Chain

⚠ CAUTION: Before beginning the sharpening procedure, make sure chain saw power source is disconnected. Wear gloves to protect hands.

1. The saw chain needs sharpening when it must be forced onto the wood

or it does not produce wood chips as large as when new.

2. Following the tensioning procedure on page 4, adjust chain tension extra tight so cutters are firm and remain steady as sharpened.

3. To sharpen the cutters, you will need a 5/32 round file and a file guide.

4. First, file all left hand cutters (from inside out). Then file all right hand cutters. The correct angle is 30° (Fig. 21).

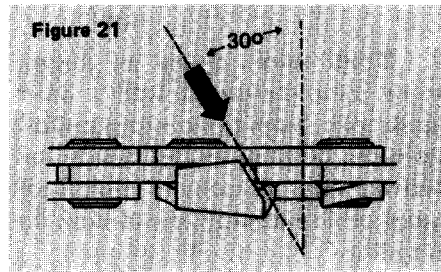

5. Press File Guide so it rides on both cutter top plate and depth gauge, with guide marks in line with the length of chain (Fig. 22).

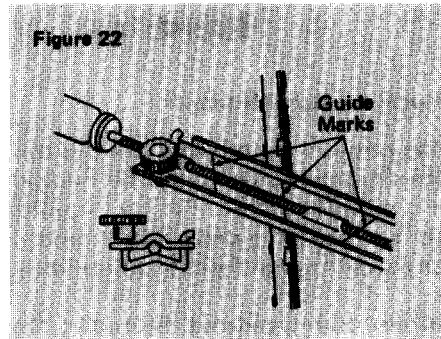

Maintenance (cont.)

6. Move to other side of chain and file all cutters opposite to complete chain sharpening. File all cutters identically (Fig. 23).

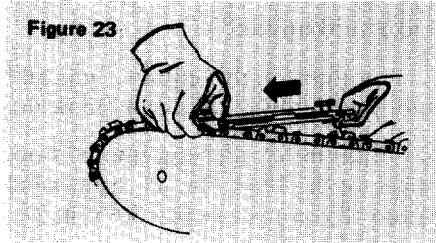

7. Depth gauges should be checked every third sharpening with a depth gauge tool. Depth gauge setting is .025". Place the depth gauge tool as indicated and file away portions of each depth gauge which extend above the tool's slot (Fig. 24).

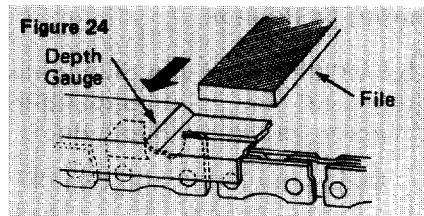

8. Round off leading edges of depth gauges as shown (Fig. 25).

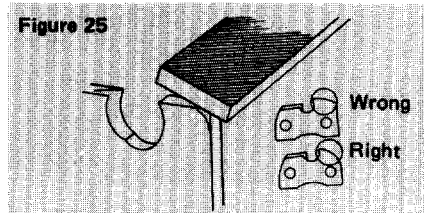

9. **IMPORTANT:** Reset saw chain tension. See instructions on page 4.

10. Any other servicing should be performed by an authorized TORO Service Dealer.

Identification and Ordering

Model and Serial Numbers

The compact electric chain saw has two identification numbers: a model number and a serial number. The two numbers are stamped on a decal that is located on the right side of the chain saw housing.

In any correspondence concerning the chain saw, supply model and serial numbers to assure that correct information and replacement parts are obtained.

To order replacement parts from an Authorized TORO Service Dealer supply the following information:

1. Model and serial numbers of the compact electric chain saw.
2. Part number, description, and quantity of part(s) desired.

NOTE: Do not order by reference number from parts catalog; use the PART NUMBER.

Chain Saw Parts List

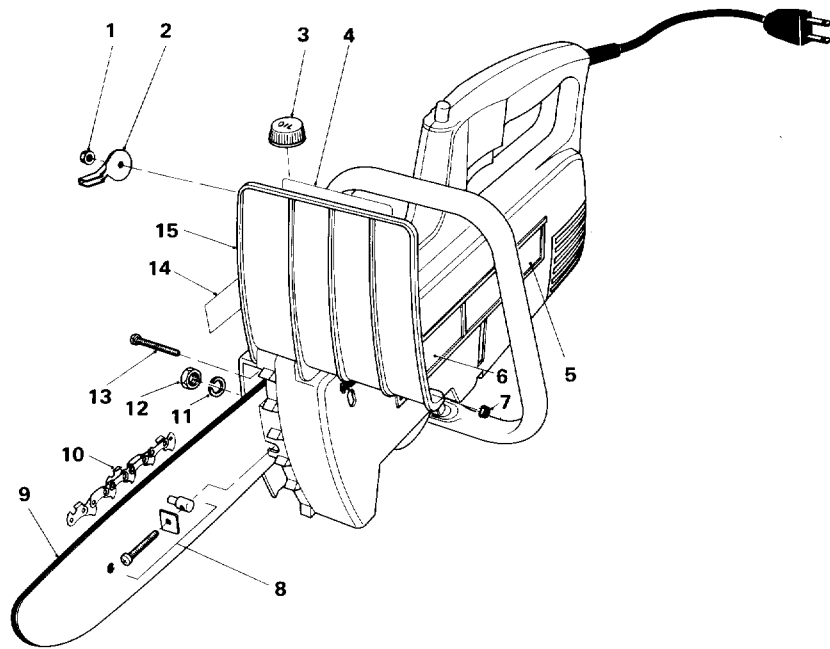

Ref. No.	Part No.	Description	No. Used
1	34-6040	Flange Nut	1
2	34-6150	Shaft Support Bracket	1
3	34-6370	Oil Cap	1
4	34-1460	Decal - Caution	1
5	34-0980	Decal - Chainsaw	1
6	34-0960	Decal - Toro L.H.	1
7	34-6400	Hex Nut	1
8	34-6300	Adjusting Block Assembly	1
9	33-8290	Guide Bar	1
10	34-3400	Saw Chain	1
11	34-5980	Spring Washer	1
12	34-5970	Nut	1
13	34-5950	Screw	1
14	34-0970	Decal - Toro R.H.	1
15	34-6090	Handguard	1

**Toro also has a full line of
premium-quality snowthrower products...**

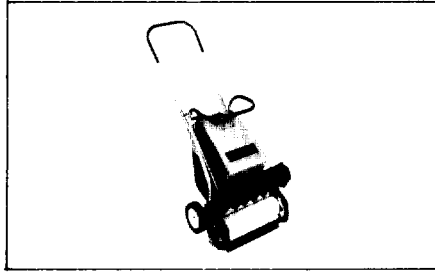

Model 38100 S-140 Recoil

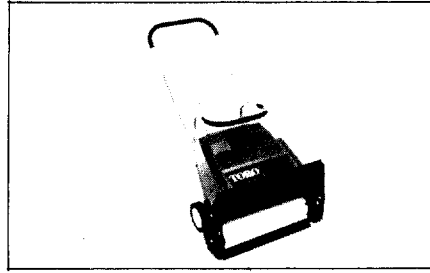

Model 38120 S-200 Recoil

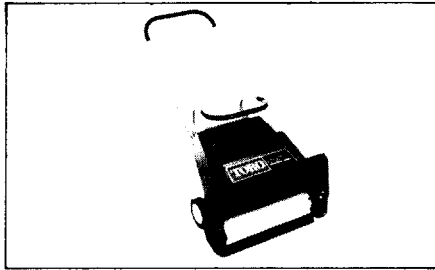

Model 38130 S-200 Electric Start

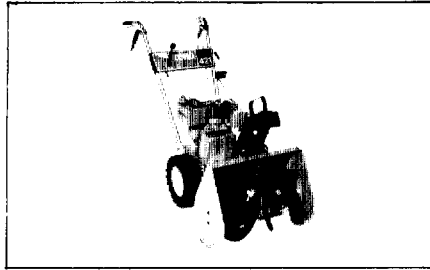

Model 38010 421 Snowthrower

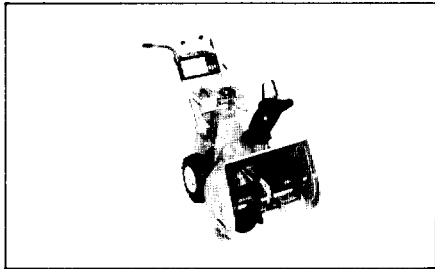

Model 38040 524 Snowthrower

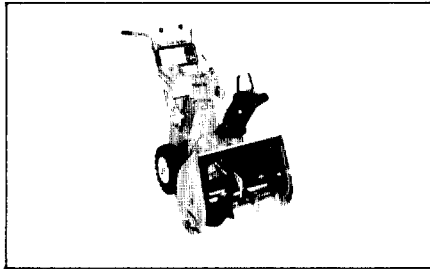

Model 38050 724 Snowthrower

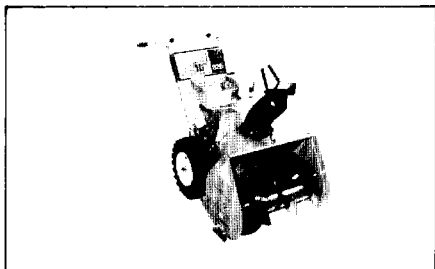

Model 38150 826 Snowthrower

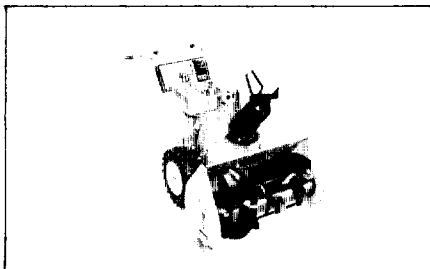

Model 38090 1132 Snowthrower

Haven't you done without a Toro long enough?®

**The Toro Promise
A Full One Year Warranty**

TORO warrants your electric outdoor appliance against defects in material or workmanship for a period of one year from the date of purchase when used non-commercially. During the warranty period, TORO will, at its option, replace a defective electric outdoor appliance with a new or rebuilt unit, or will repair or replace any defective parts. Just return your electric outdoor appliance, transportation prepaid, to either: (1) the retailer who sold it to you or, (2) any Toro Appliance Service Dealer, or (3) our Toro Service Center, Galahad Road and Wisconsin Street, North Hudson, Wisconsin 54016. Proof of purchase may be required. This warranty gives you specific legal rights, and you may also have other rights which vary from state to state.

.....
Detach here and retain this section for your records.

PLACE
FIRST-CLASS
STAMP
HERE

TORO[®]

**Outdoor Appliance Division
Post Office Box 5826
Denver, Colorado 80217**

.....
Please fold here.

**Which of the following interests and hobbies
do you and your family enjoy?**

- 1. Tennis
- 2. Golf
- 3. Snow Skiing
- 4. Running/Jogging
- 5. Camping/Hiking
- 6. Hunting/Shooting
- 7. Fishing
- 8. Bicycling
- 9. Racquetball
- 10. Sailing/Boating
- 11. Stamp/Coin Collecting
- 12. Motorbiking/Motorcycling
- 13. Home Video Games
- 14. Physical Fitness/Exercise
- 15. Home Video Recording
- 16. Recreational Vehicle/4-WD
- 17. Photography
- 18. CB Radio
- 19. Home Workshop/Do-It-Yourself
- 20. Gardening/Plants
- 21. Electronics
- 22. Automotive Work
- 23. Sewing/Needlework
- 24. Crafts
- 25. Collectibles/Collections
- 26. Art & Antiques
- 28. Foreign Travel
- 29. Attending Cultural/Arts Events
- 30. Gourmet Foods/Cooking
- 31. Health/Natural Foods
- 32. Wines
- 33. Fashion Clothing
- 34. Home Furnishings/Decorating
- 35. Records & Tapes
- 36. Avid Book Reading
- 37. Science Fiction
- 38. Astrology/Occult
- 39. Stock/Bond Investments
- 40. Real Estate Investments
- 41. Self Improvement Programs
- 42. Community/Civic Activities

We appreciate your taking the time to complete this card; the information provided will help us serve you better in the future. We participate in a multi-company program whereby you can receive information about new products, developments, trends, etc. related to the interest areas and other information you have indicated above. Please check here if you would prefer not to learn about such products and services.

**Please send further comments and suggestions
to The Toro Company, Outdoor Appliance
Division, 8111 Lyndale Avenue South.**