



MODEL: 38040 — 1000001 THRU  
4000001 & UP

## OPERATOR'S MANUAL

### 524 SNOWTHROWER

The 524 SNOWTHROWER meets or exceeds the Outdoor Power Equipment Institute's safety standards for



snowthrowers; thus, Toro proudly displays the OPEI safety seal.

To assure maximum safety, optimum performance, and to gain knowledge of the machine, it is essential that you or any other operator of the machine read and understand the contents of this manual before the engine is started. Pay particular attention to the instructions highlighted by the triangular safety alert symbol. Failure to comply with the safety instructions may result in personal injury.

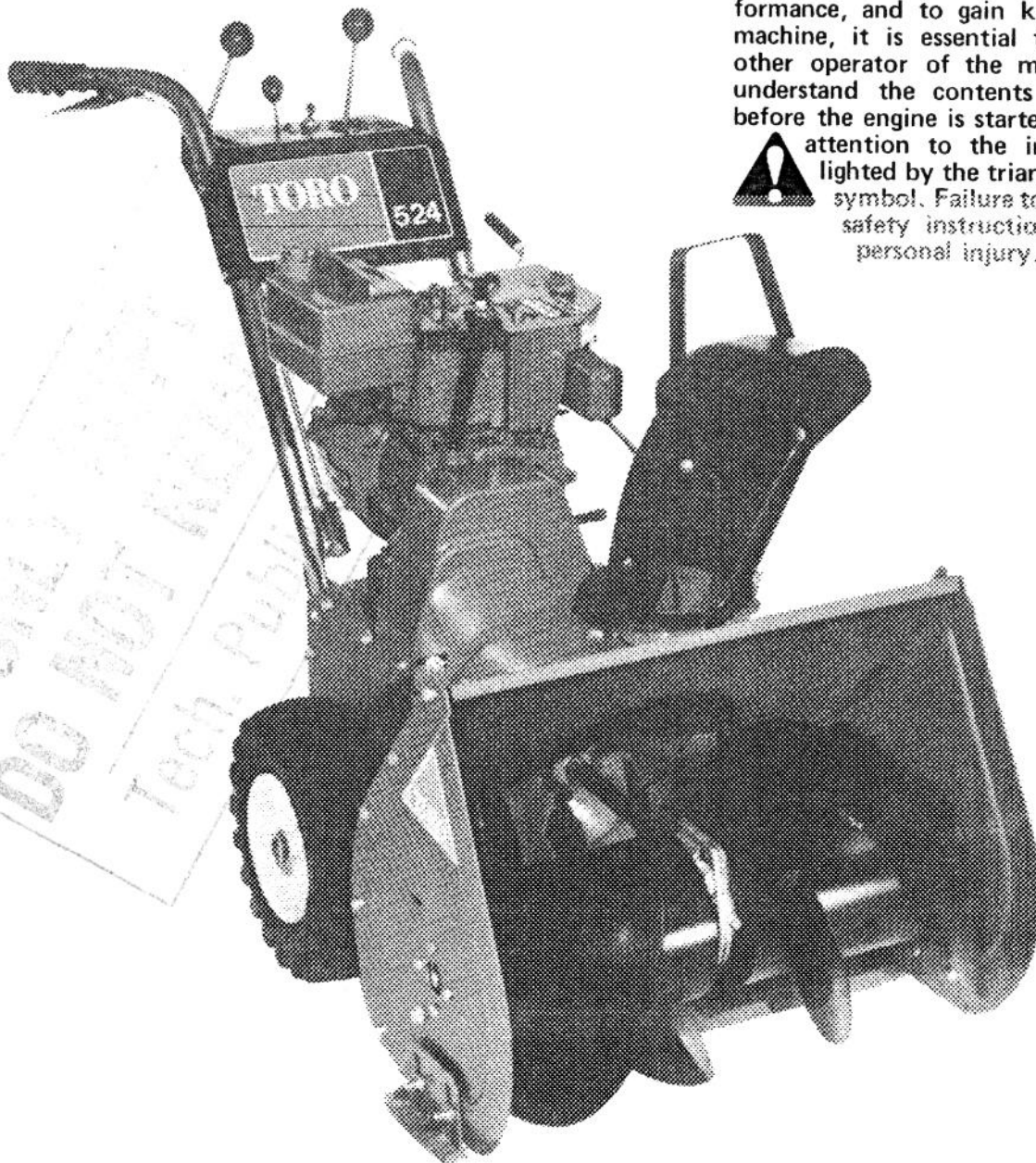

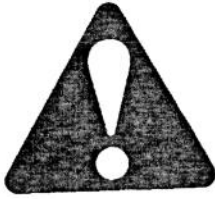

# SAFETY DECALS

Safety and instruction decals are located on the snowthrower chassis and engine. Replace any decal that is damaged.

ON BACK OF ENGINE

**CAUTION** **ATTENTION**

- STOP ENGINE BEFORE SERVICING OR MAKING ADJUSTMENTS.
- READ YOUR OWNERS MANUAL FOR OPERATING AND SAFETY INSTRUCTIONS. IF YOU DO NOT HAVE AN OWNERS MANUAL WRITE US, INCLUDING MODEL AND SERIAL NUMBERS.
- ARRETEZ LE MOTEUR AVANT DE REGLER OU DE REPARER
- LISEZ LE MANUEL DU PROPRIETAIRE ET LES REGLES DE SECURITE. SI VOUS N'AVEZ PAS DE MANUEL DU PROPRIETAIRE, ECRIVEZ-NOUS, EN INDIQUANT LE MODELE ET LE NUMERO DE SERIE.

THE TORO COMPANY, 8111 LYNDALE AVE S MINNEAPOLIS, MN 55420

(Part No. 41-8540)

**CHOKER**  
ETRANGLEUR

NEXT TO  
CHOKER

(Part No. 39-3840)

PRIMER  
PUSH TO  
PRIME  
AMORCEUR  
POUSSEZ  
POUR  
AMORCER

NEXT TO  
PRIMER

(Part No. 39-3860)

ON ENGINE

**WARNING**  
HOT SURFACES

**ATTENTION**  
SURFACE CHAUDE

(Part No. 29-6390)

RIGHT  
DROITE

CHUTE DIRECTION

SENS DE  
L'EJECTEUR

LEFT  
GAUCHE

ON CHUTE  
CONTROL  
BRACKET

(Part No. 29-6370)

ON AUGER HOUSING

**ATTENTION** **WARNING**

- GARDEZ LES MAINS HORS DE L'EJECTEUR ET DEMEUREZ A L'ECART DE LA TARIERE QUAND LE MOTEUR EST EN MARCHÉ
- ARRETEZ LE MOTEUR AVANT TOUT DEBLOCAGE OU ENLEVEMENT DE DEBRIS
- NE DIRIGEZ JAMAIS L'EJECTEUR VERS AUTRUI
- KEEP HANDS OUT OF CHUTE AND KEEP CLEAR OF AUGER WHILE ENGINE IS RUNNING
- STOP ENGINE BEFORE UN-CLOGGING OR REMOVING DEBRIS
- DO NOT DIRECT DISCHARGE AT BYSTANDERS

(Part No. 29-6350)

NEAR HANDLE GRIP

SAFETY  
INTERLOCK  
UP TO RUN

INTERCONNEXION  
DE SECURITE  
POSITION DE  
MARCHÉ EN HAUT

(Part No. 29-6360)

## FOREWORD

The 524 Snowthrower is an outstanding product for snow removal. It has advanced concepts in engineering, design and safety; and if maintained properly, the snowthrower will be reliable.

Since the snowthrower is a high-quality product, Toro is concerned about the future use of the product and the safety of the user. Therefore, read this entire manual to familiarize yourself with the safety instructions and product. The five major sections of this manual are:

1. Safety Instructions
2. Setting Up Instructions
3. Preparation Before Starting
4. Operating Instructions
5. Maintenance

Note that safety, mechanical and some general information in the manual is emphasized. The words CAUTION, WARNING, DANGER, IMPORTANT and NOTE are used to classify the information. CAUTION, WARNING and DANGER identify safety related information, IMPORTANT identifies special mechanical information, and NOTE identifies general information worthy of special attention.

If help — concerning set-up, operation, maintenance or safety — is ever needed, contact the local Authorized TORO Service Dealer or Distributor. Refer to the "Yellow Pages" for assistance. In addition to skilled service technicians, the dealer and distributor have other TORO Products, as well as factory approved accessories and replacement parts. Keep your Toro all TORO. Buy genuine TORO replacement parts and accessories.

## TABLE OF CONTENTS

	Page		Page
Specifications . . . . .	5	Lubricating Snowthrower . . . . .	14
Loose Parts . . . . .	5	Changing Crankcase Oil . . . . .	15
Setting Up Instructions . . . . .	6-9	Changing Auger Gear Box Oil . . . . .	15
Preparation Before Starting . . . . .	9-10	Adjusting Skids . . . . .	16
Fill Crankcase With Oil . . . . .	9	Replacing Traction Drive Belt . . . . .	16
Fill Fuel Tank With Gasoline . . . . .	10	Replacing Auger/Impeller Drive Belt . . . . .	17
Controls . . . . .	11	Adjusting Auger/Impeller Drive Belt . . . . .	17
Starting and Stopping Instructions . . . . .	12	Adjusting Traction Disc . . . . .	17
Operating Instructions . . . . .	13	Replacing Spark Plug . . . . .	18
Free Wheeling or Self Propelled Drive . . . . .	13	Adjusting Carburetor . . . . .	18
Checking Safety Interlock System . . . . .	13	Preparing Snowthrower For Storage . . . . .	19
Snowthrowing Tips . . . . .	13	Identification and Ordering . . . . .	20
Maintenance . . . . .	14-19	Maintenance Chart . . . . .	20-23
Draining Gasoline . . . . .	14	Toro Promise . . . . .	Back Page

# SAFETY INSTRUCTIONS



To assure maximum safety, optimum performance, and to gain knowledge of the product, it is essential that you or any other operator of the snowthrower read and understand the con-

tents of this manual before the engine is ever started. Pay particular attention to the safety alert symbol which means CAUTION, WARNING, or DANGER – “personal safety instruction”. Read and understand the instruction because it has to do with safety. Failure to comply with the instruction may result in personal injury.

The following instructions are comparable to the Instructions For Safe Snowthrowing adopted by ANSI – American National Standards Institute. The snowthrower is designed and tested to offer reasonably safe service; however, failure to operate it in accordance with the following Safety Instructions **MAY RESULT IN PERSONAL INJURY.**

## BEFORE OPERATING

1. Read and understand the contents of this manual before starting and operating the machine. Become familiar with all controls and know how to stop the engine quickly.
2. Keep everyone, especially children and pets, away from the area of operation. Never allow children to operate the snowthrower.
3. Inspect area thoroughly where snowthrower will be used. Remove door mats, sleds, boards, sticks, wire and any other foreign objects which might be picked up and thrown by the snowthrower.
4. Keep all shields and safety devices in place. If a shield, safety device or decal is defective or damaged, repair or replace it before operation is commenced. Also, tighten any loose nuts, bolts and screws.
5. Wear adequate winter clothing and footwear that will improve footing on slippery surfaces. Do not wear loose fitting clothing that could possibly get caught in moving parts.
6. Adjust both skids so auger housing clears gravel or crushed rock surfaces.
7. Before starting the engine, move auger drive control to **DISENGAGE** and wheel drive control to **N** (neutral).

8. Always use a grounded three wire plug and cord to start snowthrower equipped with an electric starter.

9. Fill fuel tank with gasoline before starting the engine. Avoid spilling any gasoline. Since gasoline is highly flammable, handle it carefully. **DO NOT SMOKE.**

- A. Use an approved gasoline container.
- B. Fill fuel tank outdoors and only when engine is not running. Engine must be cool to prevent a potential fire hazard.
- C. Open doors if engine will be run in the garage because exhaust fumes are dangerous and could possibly be deadly. Do not run engine indoors.
- D. Wipe up any gasoline that spilled, and install gasoline container cap and snowthrower fuel tank cap securely before starting the engine.

## WHILE OPERATING

10. Keep people and pets a safe distance away from the snowthrower and area of operation.
11. Allow engine to warm up for about 2 minutes and machine to adjust to outdoor temperature before clearing snow.
12. Do not run engine indoors, except when starting engine. When starting engine indoors, open outside doors because exhaust gasses are dangerous.
13. Operate the snowthrower only when there is good visibility or light. Always maintain secure footing and keep a firm grip on the handles, especially when operating in reverse.
14. Be attentive when using the snowthrower, and stay alert for holes in the terrain and other hidden hazards. Be careful when clearing snow from a gravel drive because stones could be picked up and thrown if the skids are not adjusted so auger housing clears all rocks.
15. **STAY BEHIND THE HANDLES AND AWAY FROM DISCHARGE OPENING WHILE OPERATING THE SNOWTHROWER.** Keep face, hands, feet and any other part of your body or clothing away from concealed, moving or rotating parts.
16. Do not make any adjustments while the engine is running.

# SAFETY INSTRUCTIONS

17. Never direct discharge of snow or operate snowthrower near bystanders, glass enclosures, automobiles and trucks, window wells or a drop-off without proper adjustment of the snow discharge angle.

18. Clear snow from slopes by going up and down; never across the face, and use caution when changing directions. Never clear snow from steep slopes.

19. Do not overload the snowthrower by clearing snow at too fast a rate.

20. If a solid object is hit or snowthrower vibrates abnormally, shut engine off and wait for all movement to stop. Pull high tension wire off spark plug and check snowthrower immediately for possible damage, an obstruction or loose parts. Vibration is generally a warning of trouble. Repair any damage before restarting engine and operating snowthrower again.

21. Do not touch engine while it is running or soon after it is stopped because the engine will be hot enough to cause a burn. Do not add oil or check oil level in crankcase when engine is running because this could be a potential hazard.

22. Check the safety interlock system everytime snowthrower is used: refer to page 13. If the interlock system does not operate properly, have the interlock system repaired immediately by an Authorized TORO Service Dealer.

23. Before leaving the operator's position — behind handles — move gear auger drive control to DISENGAGE, shift to N (neutral), and rotate ignition key to OFF. Remove key from switch if snowthrower will be left unattended.

24. Before adjusting, cleaning, repairing and inspecting the snowthrower, and before unclogging the discharge chute, shut engine off and wait for all moving parts to stop. Also, pull high tension wire off spark plug and keep wire away from the plug to prevent accidental starting. Use a stick to remove obstructions.

25. Move auger drive control to DISENGAGE before transporting or storing the snowthrower. Never operate snowthrower at high transport speeds on slippery surfaces. Use care when backing.

26. Let engine run for a few minutes after clearing snow so moving parts do not freeze.

## MAINTAINING SNOWTHROWER

27. Perform only those maintenance instructions described in this manual. Shut engine off before

performing any maintenance service or adjustment. Additionally, pull high tension wire off spark plug and keep wire away from plug to prevent possibility of accidental starting. If major repairs are ever needed, contact the local Authorized TORO Service Dealer for assistance.

28. Keep snowthrower in safe operating condition by keeping nuts, bolts and screws tight. Check engine mounting bolts frequently to assure they are tight.

29. Do not overspeed the engine by changing governor settings. Recommended maximum engine speed is 3500 rpm. To assure safety and accuracy, check maximum engine speed (3500 rpm) with a tachometer.

30. Allow engine to cool before storing snowthrower in an enclosure such as a garage or storage shed, and make sure the snowthrower fuel tank is empty. Do not store snowthrower near any open flame or where gasoline fumes may be ignited by a spark.

31. When storing the snowthrower for an extended time — off season storage or 30 days — drain gasoline from fuel tank to prevent a potential hazard. Store gasoline in a safety-approved red metal container. Remove key from ignition switch and keep it in a memorable place.

32. At the time of manufacture, the snowthrower conformed with and exceeded safety standards in effect for snowthrowers. Therefore, to assure optimum performance and safety, purchase genuine TORO replacement parts and accessories to keep the TORO all TORO. NEVER USE "WILL-FIT" REPLACEMENT PARTS AND ACCESSORIES. The TORO logo assures genuineness.

33. For safety reasons, use only those accessories and attachments recommended by The TORO Company to assure continued safety certification of the product. Using unapproved accessories and attachments could contribute to a potential hazard.





# SPECIFICATIONS

**5 hp (3.7 kw) \*Tecumseh Engine:** Model H50, four cycle, air cooled engine with an output of 5 hp (3.7 kw) @ 3600 rpm and 7.8 ft-lb (10.6 N·m) of torque @ 2800 rpm. Displacement is 12 cubic inches (196.6 cc). Maximum no load governor setting is 3150–3500 rpm.

**Fuel Tank:** Tank is made of high-density polyethylene and it has a winterized cap with side vent. Approximate tank capacity is two quarts (1.89 l).

**Auger:** Two section drum-type auger is made of heavy gauge steel, welded type construction. Each auger section has two flights that are 3-1/2 inches (89 mm) deep. Approximate diameter of auger is 14 inches (0.356 m). Auger speed is 124 rpm when engine is running at 3400 rpm.

**Auger Housing:** Housing is 24 inches (0.61 m) wide and 20 inches (0.508 m) high. The pivoting scraper blade has a rotational height of approximately one inch (25 mm). By adjusting skids at sides of auger housing side plates, height of auger housing can range from 0 to 2 inches (51 mm) from the ground.

**Auger/Impeller Drive:** Drive is belt-type with idler pulley, with power transmitted to a worm gear which drives the auger and impeller; reduction is 9.00:1.

**Impeller:** The three blade, 12 inch (30.5 cm) diameter impeller is made of heavy gauge steel, welded type construction. Impeller speed is 1115 rpm when engine is running at 3400 rpm. Blade tip speed of impeller is 3500 ft/min (17 780 m/s) when engine is running at 3400 rpm. When auger drive control is disengaged, brake mechanism stops impeller in less than five seconds.

**Discharge Chute:** Chute is made of heavy gauge steel and has throat diameter of approximately 5-1/2 inches (14.0 cm). Chute angle of rotation

from side to side is 200° and deflector angle of rotation is 60° up and down.

**Tires:** Pneumatic tire is 13 x 4.00-6 and has staggered lug tread. Track width from outside of tires is approximately 23 inches (0.58 m).

**Traction Drive Transmission:** Friction disc-type drive with forward speeds of 0.9, 1.5, and 2.2 mph (1.4, 2.4, 3.5 km/hr), and reverse speeds of 1.0 and 1.8 mph (1.6, 2.9 km/hr) at engine speed of 3400 rpm. Moveable axle pins for freewheeling or direct drive to wheels.

**Controls:** Mounted on control panel are the throttle, ignition switch, wheel drive control, and auger drive control. Chute control rod is mounted at side of left handle, and interlock lever is mounted at grip end of right handle. Engine has manual choke, primer, and recoil starter.

**Handles:** Two 1-1/4 inch (32 mm) diameter steel tubing handles with chrome plating. Grip at end of both handles. Width between handles is approximately 23 inches (0.58 m) and height to top of handle grip is approximately 36 inches (0.914 m).

## Dimensions:

Overall width is approximately 27 inches (0.686 m)

Overall length is approximately 56 inches (1.42 m)

Overall height is approximately 42 inches (1.067 m)

**Weight:** Approximate dry weight is 220 pounds (979 N).

## Accessories:

110 VAC U.S.A. and Canadian Electric Starter (part no. 38-7590)

Tire Chains (part no. 20-9800)

Drift Breaker/Storage Bar (part no. 20-0690)

Snow Cab (part no. 42-3380)

Heavy Duty Skids (part no. 20-2850)

Grader Blade (part no. 59099)

\*Engine Manufacturers Rating

# LOOSE PARTS

Part	Qty.	Use
Flange Screws	4	Install Handles, page 6
Sems Screw & Locknut	2	Install Throttle, page 6
Small Knob	1	
Clevis Pin & Cotter Pin	1	Install Auger Drive Control Rod, page 7,
Clevis Pin & Cotter Pin	2	Install Wheel Drive Control Rods, page 7
Capscrew & Locknut	1	Install Discharge Chute, page 8
Carriage Bolt, Locknut, Pyramidal Washer & Washer	1	Install Discharge Chute, page 8
Keys	2	Use in ignition switch
Registration Card	2	Used to validate product warranty

# SETTING UP INSTRUCTIONS

**Note:** Determine left and right sides of snowthrower by standing in the normal operating position.

## INSTALL HANDLES

1. Remove carton from around snowthrower.
2. Remove plastic ties from handles, controls, and any other area of the unit.
3. Slide handles to the inside of the side plates and line up all holes (Fig. 1).

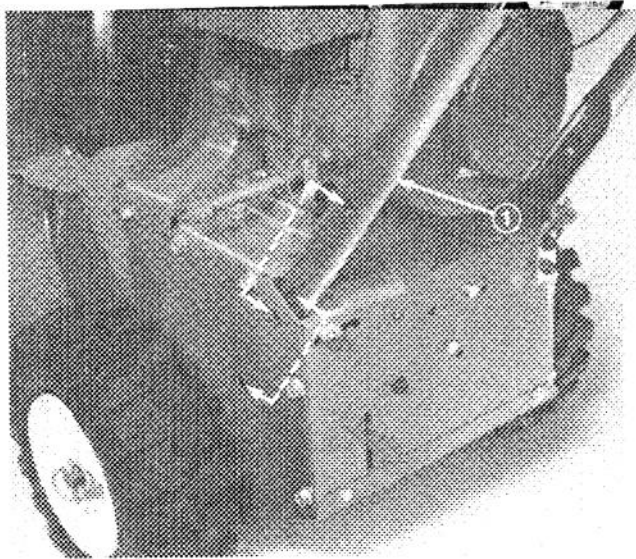

Figure 1  
1. Handle

4. Secure handles to side plates with hex flange screws. (Fig. 2).

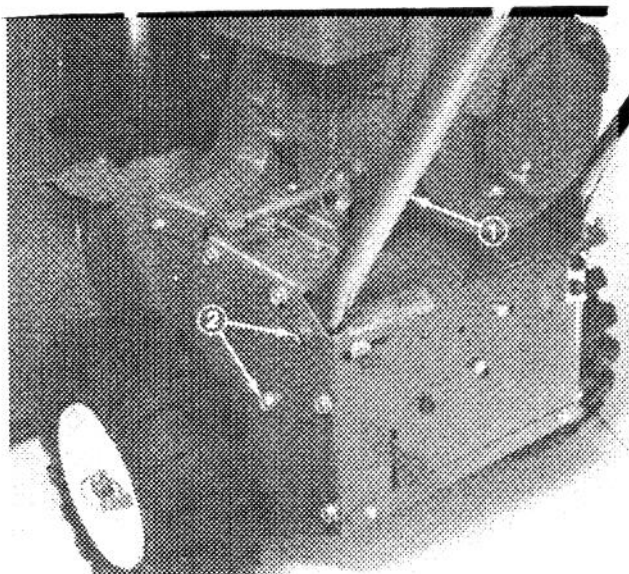

Figure 2  
1. Handle  
2. Hex flange screws

## INSTALL THROTTLE CONTROL

1. Hold throttle control behind control panel so cable points down; then move control lever fully to the rear.
2. From back side, slide throttle control lever in front of pivot rod and through slot in control panel. Next, secure throttle control plate in place with two hex head sems screws and locknuts (Fig. 3).

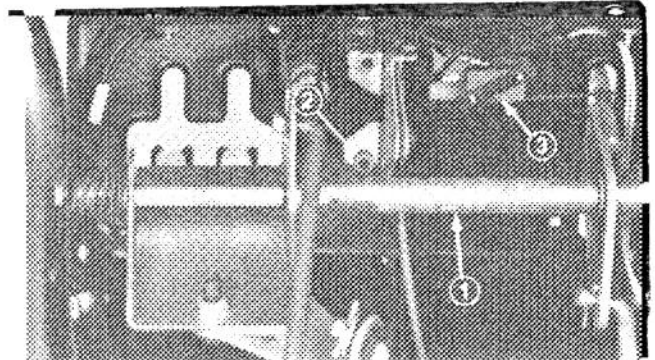

Figure 3

1. Pivot rod
2. Sems screws and locknuts
3. Auger interlock switch

**Note:** Make sure throttle control cable is not bent or kinked and electrical wires are not pinched by the plate or strained at connection to auger interlock switch.

3. Push, or if necessary, tap small knob onto throttle lever.

## INSTALL AUGER DRIVE CONTROL ROD

1. Move auger drive control backward to DIS-ENGAGE and hold it in that position.
2. Rotate clevis at end of auger drive control rod until holes in clevis line up with hole in bent rod (Fig. 4). Next, secure clevis and bent rod together with clevis pin and cotter pin (Fig. 4).

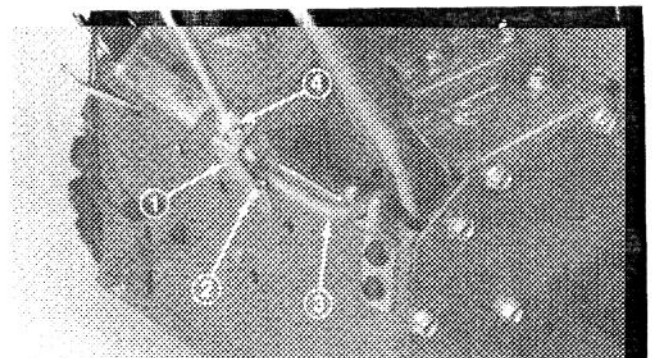

Figure 4

1. Clevis
2. Clevis pin and cotter pin
3. Bent rod
4. Jam nut

# SETTING UP INSTRUCTIONS

3. Tighten the jam nut firmly against top of clevis (Fig. 4).

**Note:** Move auger drive control forward to EN-GAGE. If excessive force is required to move the control, adjust the auger drive control: refer to Adjusting Auger/Impeller Drive Belt, page 17.

## INSTALL WHEEL DRIVE CONTROL RODS

1. Move wheel drive control into No. 1, 1st gear. Position control lever so its front surface is 1/4 of an inch (6 mm) from bottom of slot (Fig. 5); then hold lever in this position.

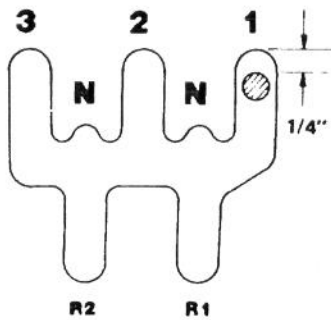

Figure 5

2. While holding wheel drive control lever in position, push up on long rod and rotate clevis until holes in clevis line up with hole in link arm (Fig. 6). Next, secure clevis and link arm together with clevis pin and cotter pin (Fig. 6).

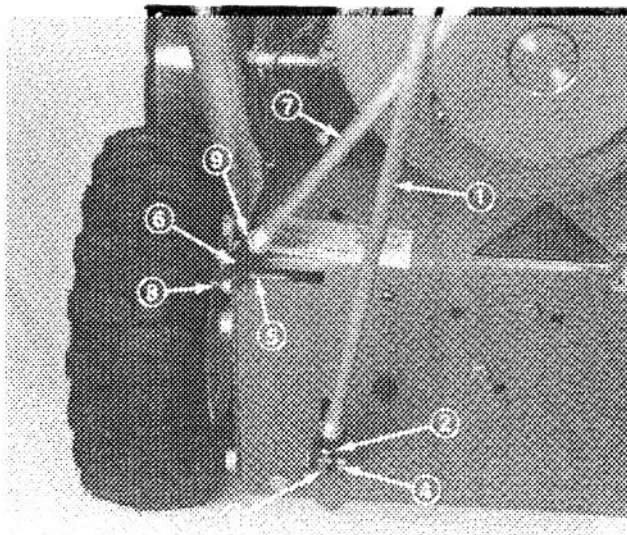

Figure 6

- |                              |                              |
|------------------------------|------------------------------|
| 1. Long rod                  | 6. Clevis                    |
| 2. Clevis                    | 7. Short rod                 |
| 3. Link arm                  | 8. Clevis pin and cotter pin |
| 4. Clevis pin and cotter pin | 9. Jam nut                   |
| 5. Shift arm                 |                              |

3. Move wheel drive control lever onto the hump between N and 1 (Fig. 7). Hold wheel drive control lever, in this position – on hump.

**Note:** Lever must be held against the hump, not in the N or 1 position.

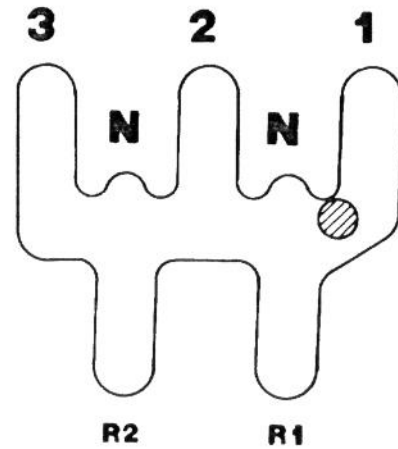

Figure 7

4. Move shift arm fully to the left (Fig. 6). Next, rotate clevis at end of shortest rod until holes in clevis line up with hole in shift arm (Fig. 6). Secure clevis and shift arm together with clevis pin and cotter pin (Fig. 6).

5. Tighten the jam nut against top of both clevises (Fig. 6).

## INSTALL DISCHARGE CHUTE

1. Rotate retaining ring so teeth are toward left side of unit (Fig. 8). Next, remove three self tapping screws from top of retaining ring, but do not remove the screw near "TOP" marking, which is on the retaining ring.

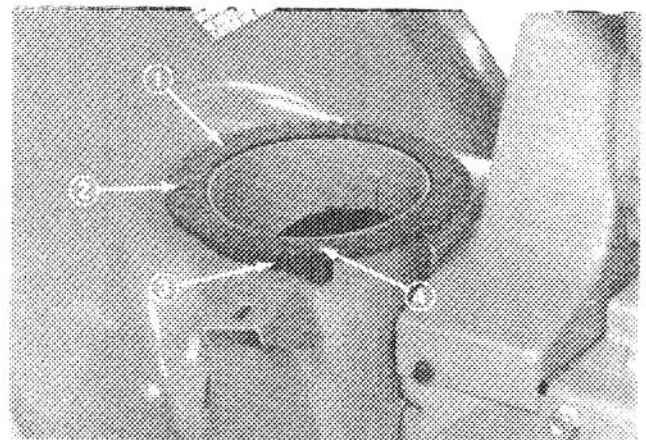

Figure 8

- |                   |                     |
|-------------------|---------------------|
| 1. Retaining ring | 3. Plastic retainer |
| 2. Top marking    | 4. Line up holes    |



# SETTING UP INSTRUCTIONS

2. The two curved plastic retainers are slotted and are used to secure the discharge chute. Therefore, keep retainers in place (Fig. 8).

3. Move opposite end of retainer under the retaining ring so mounting holes line up and slot in retainer fits over the collar at top of discharge opening (Fig. 8).

4. Set discharge chute — open side forward — onto retaining ring and line up mounting holes. Next, secure discharge chute, retaining ring, and plastic retainers together with three self tapping screws (Fig. 9).

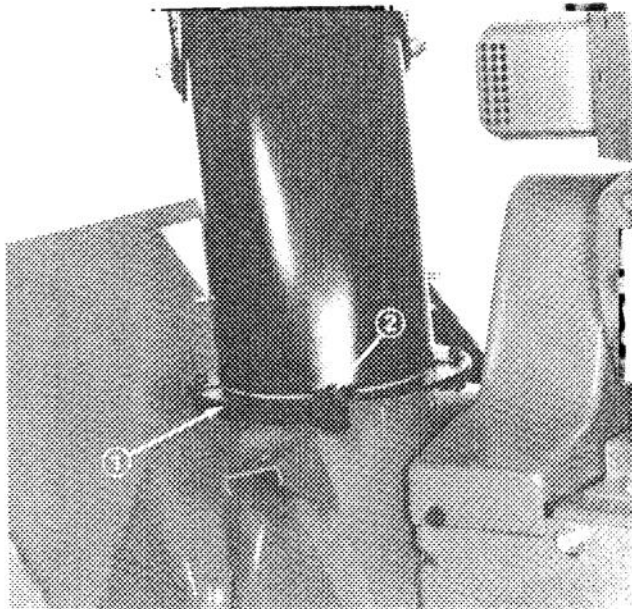

Figure 9

1. Plastic retainer
2. Self tapping screw

5. Tighten self tapping screw near "TOP" marking so discharge chute is held securely in place.

6. Install chute control bracket and rod against left side of handle with capscrew and locknut; but do not tighten the locknut (Fig. 10).

7. Apply No. 2 general purpose grease on worm gear. Next, mount worm bracket and gear on top of mounting flange with carriage bolt, pyramidal washer, flat washer and cone locknut (Fig. 11). Do not tighten locknut.

**Note:** Flat washer to be between worm bracket and mounting flange.

8. Push worm firmly against teeth in retaining ring; then tighten locknut (Fig. 11). Also tighten locknut holding chute control bracket against left handle (Fig. 10).

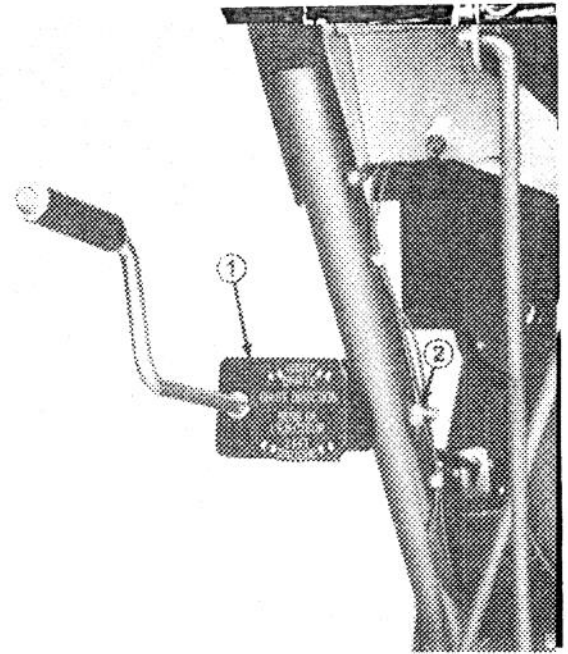

Figure 10

1. Chute control bracket
2. Capscrew and locknut

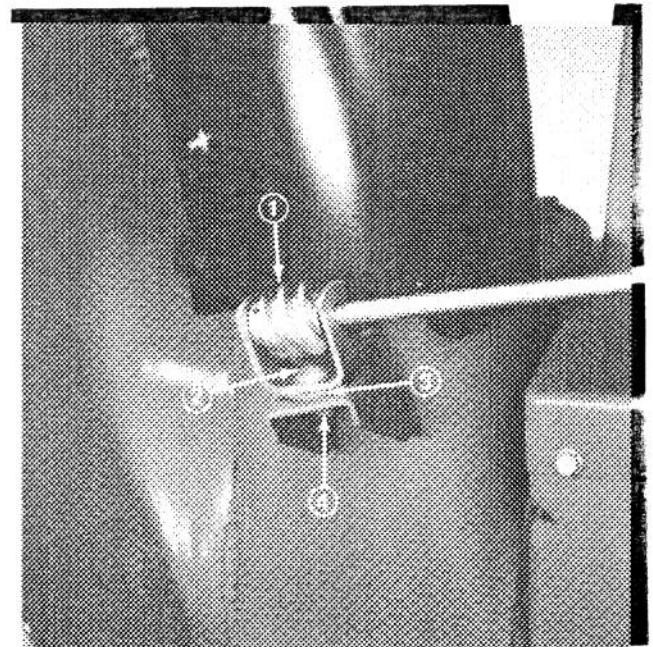

Figure 11

1. Worm gear
2. Carriage bolt
3. Flatwasher
4. Washer and locknut

## CONNECT WIRES

1. Plug handle wires firmly into plug on engine. (Fig. 12)



## SETTING UP INSTRUCTIONS

2. Push plastic retaining clip holding the wires into hole on top left of main frame (Fig. 12).

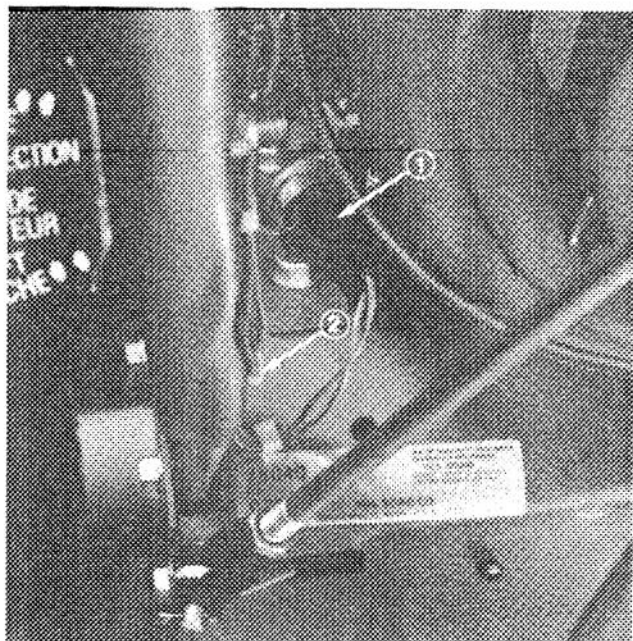

Figure 12

1. Engine plug
2. Retaining clip

### CHECK TIRE PRESSURE

**IMPORTANT:** Check pressure of tires because they are over inflated at the factory for shipping. Therefore, before the snowthrower is operated, reduce pressure in both tires to 20-25 psi.

### CHECK AUGER GEAR BOX OIL

1. Move snowthrower to a level surface.

2. Remove pipe plug from gear box by placing the open end of a 3/8" drive socket extension over plug and using a 3/8" open end wrench on the square end of the extension (Fig. 13).

3. Check level of oil in gear box. Oil must be at point of overflowing in filler opening.

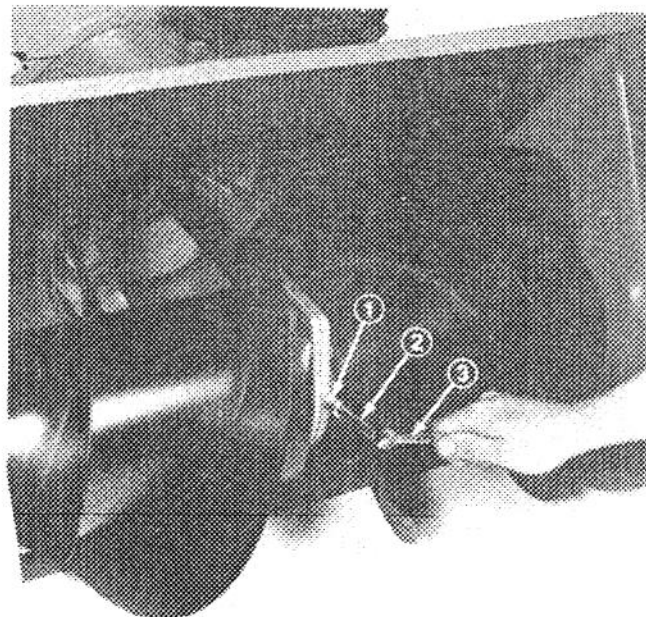

Figure 13

1. Pipe plug
2. 3/8" drive socket extension
3. 3/8" open end wrench

4. If level of oil is low, add SAE 90 EP transmission oil to the gear box until point of overflow.

5. Install pipe plug in gear box (Fig. 13).

**IMPORTANT:** Change oil in auger gear box once a year. If possible, run auger just before changing oil because warm oil flows better and carries more contaminants than cold oil.

## PREPARATION BEFORE STARTING

### FILL CRANKCASE WITH OIL

The engine is shipped from the factory without oil in the crankcase. Therefore, before trying to start engine, oil must be added to the crankcase.

**IMPORTANT:** Check level of oil every 5 operating hours or each time unit is used. Initially, change oil after the first 2 hours of operation; thereafter, under normal conditions, change oil after every 25 hours of operation. However, change oil more

frequently when engine is operated in extremely dirty conditions.

1. Move unit to a level surface to assure an accurate oil level reading.

2. Clean area around dipstick to prevent foreign matter from entering filler hole when dipstick is removed.

3. Remove dipstick from crankcase (Fig. 14).

## PREPARATION BEFORE STARTING

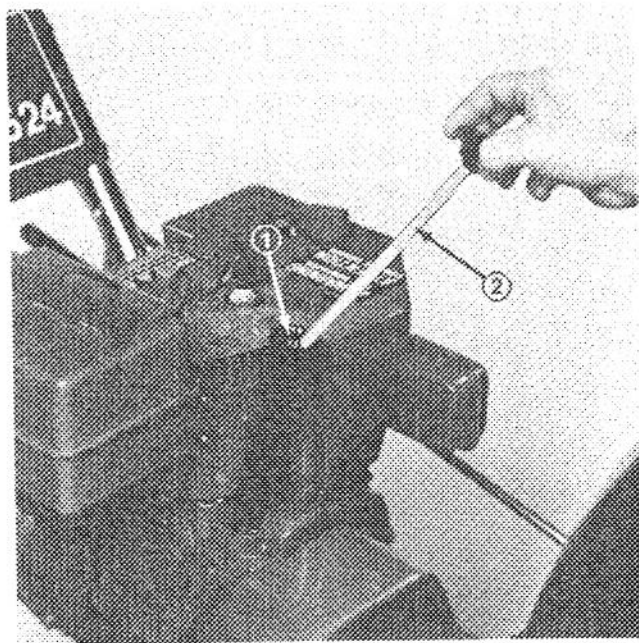

Figure 14

1. Filler hole
2. Dipstick

4. Slowly, pour 21 ounces (0.621 l) of SAE 5W30 or SAE 10 oil into the filler hole (Fig. 14). The engine uses only high-quality detergent oil having the American Petroleum Institute – API – “service classification” SC, SD or SE.

**Note:** Dipstick must be fully installed to assure accurate gauging of oil level. **DO NOT OVERFILL.**

**IMPORTANT:** Check level of oil after every 5 hours of engine operation or every time snowthrower is used. Initially, change oil after 2 hours of engine operation; thereafter, change oil after every 25 hours of operation. If possible, run engine just before changing oil because warm oil flows better and carries more contaminants than cold oil.

### FILL FUEL TANK WITH GASOLINE

**IMPORTANT:** Do not mix oil w/gasoline because engine damage and poor performance may result. Do not use premium gas, gasahol, white gas or gasoline additives. Unleaded gasoline is recom-

mended; if not available, use leaded regular gasoline.



### CAUTION

Because gasoline is flammable, caution must be used when storing or handling it. Do not fill fuel tank while engine is running, hot or when unit is in an enclosed area. Keep away from open flame and electrical spark, and **DO NOT SMOKE** while filling the fuel tank to prevent the possibility of an explosion. Always fill fuel tank outside and wipe up any spilled gasoline before starting engine. Use a funnel or spout to prevent spilling gasoline, and fill fuel tank to about 1/2 inch (13 mm) from the top of the tank, not the filler neck.

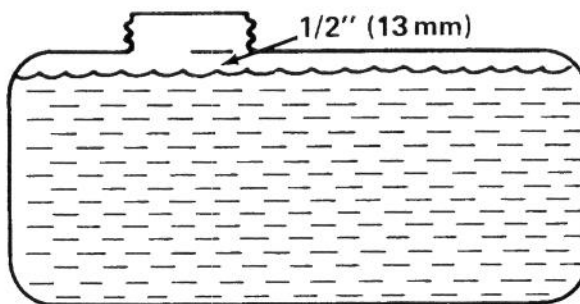

Store gasoline in a clean, approved container and keep the cap in place on the container. Keep gasoline in a cool, well-ventilated place; never in the house. To assure volatility, do not buy more than a 30 day supply of gasoline. Gasoline is a fuel for internal combustion engines; therefore, do not use it for any other purpose. Since many children like the smell of gasoline, keep it out of their reach because the fumes are explosive and dangerous to inhale.

1. Clean area around the fuel tank cap. Remove cap from fuel tank and fill tank to within 1/2 inch (13 mm) from the top with unleaded regular gasoline. Reinstall fuel tank cap.

# CONTROLS

**Auger Drive Control (Fig. 15)** – Control has two positions: ENGAGE and DISENGAGE. To engage auger and impeller, push control forward until it stops in an over center position. To disengage auger and impeller, pull control backward.

**Interlock Lever (Fig. 15)** – Interlock lever must be compressed against right handle grip when auger drive or wheel drive control is engaged. The engine will shut off if lever is released when auger drive or wheel drive control is engaged. This is a safety feature that reminds the user to disengage auger drive and wheel drive controls before leaving operator's position behind the handles.

**Wheel Drive Control (Fig. 15)** – The control has seven positions: N—neutral (2), R1 and R2—reverse, 1, 2, and 3. To change speeds, move gear shift to position desired. Control must be held in R—reverse—when backing and when it is released, gear shift automatically returns to neutral. Use positions 1, 2, and 3 depending on snow conditions. Keep interlock lever compressed when shifting.

**Throttle (Fig. 15)** – Moving the throttle forward increases engine speed. Use only enough engine speed to throw snow to the place desired.

**Ignition Switch (Fig. 15)** – Switch has two positions: ON and OFF. Rotate key to ON before starting engine with the recoil starter. To stop engine, rotate key to OFF.

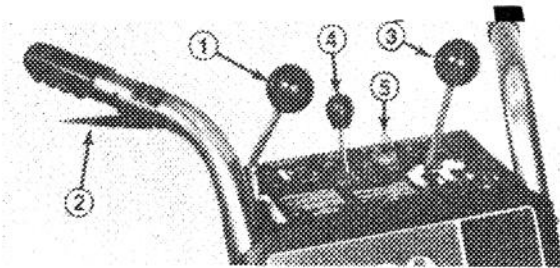

Figure 15

- 1. Auger drive control
- 2. Interlock lever
- 3. Wheel drive control
- 4. Throttle
- 5. Ignition switch

**Axle Pins (Fig. 16)** – Move axle pins to outer axle hole to get free-wheeling characteristic. Push pin through hole in wheel hub and inner axle hole to get direct drive to both wheels.

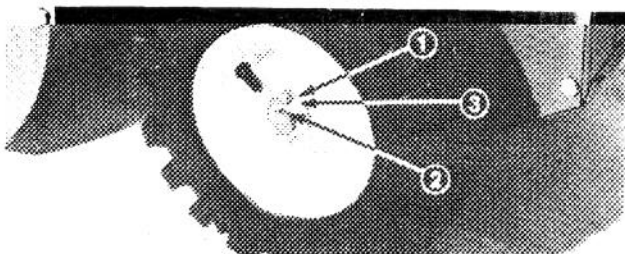

Figure 16

- 1. Axle pin
- 2. Outer axle hole
- 3. Inner axle hole and wheel hub

**Choke (Fig. 17)** – Choke is located on top of heater box. Rotate choke to FULL choke position to start a cold engine. As engine warms up, rotate choke gradually to OFF.

**Primer (Fig. 17)** – Press primer to pump small amount of gasoline into engine for improved cold weather starting.

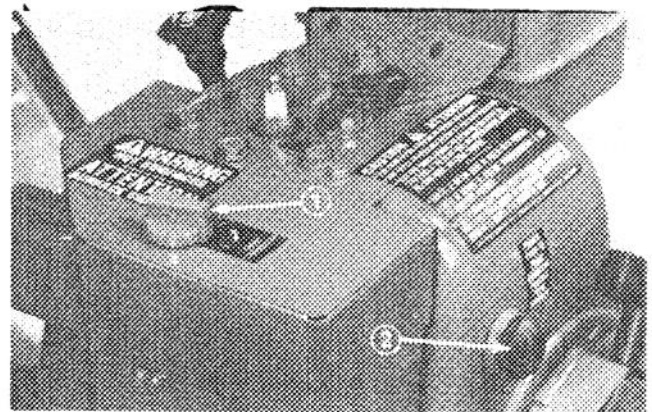

Figure 17

- 1. Choke
- 2. Primer

**Fuel Shut-Off Valve (Fig. 18)** – Valve is located under fuel tank. Close valve to stop fuel flow from fuel tank and open valve to allow fuel to flow to the carburetor. Close valve when snowthrower is not used.

**Discharge Chute Control (Fig. 18)** – Rotate discharge chute control clockwise to move discharge chute to the left and counterclockwise to move chute to the right.

**Recoil Starter (Fig. 18)** – Recoil starter is on back side of engine. Pull recoil starter to start engine.

**Deflector Handle (Fig. 18)** – Deflector handle is on top of discharge chute and it is used to control height of the snow stream.

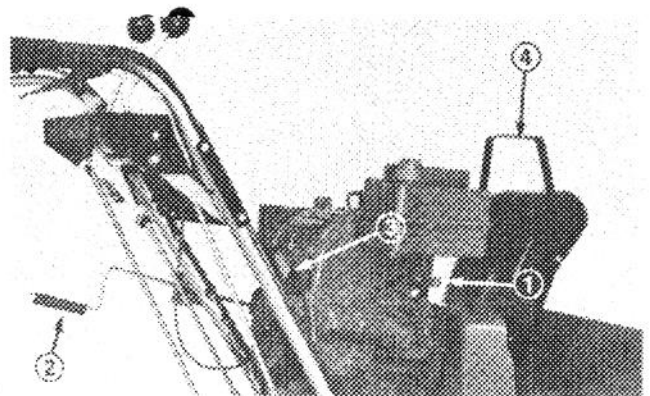

Figure 18

- 1. Fuel shut-off valve
- 2. Discharge chute control
- 3. Recoil starter
- 4. Deflector handle



# STARTING AND STOPPING INSTRUCTIONS

## TO START ENGINE

**Note:** If engine is operated when temperature is +40° F (4° C) or higher, remove carburetor heater box. However, the heater box must be reinstalled when temperature falls below +40° F (4° C). To remove heater box:

- A. Remove phillips screws securing heater box in place. Grasp choke knob and pull it off mounting pin.
- B. Lift heater box up and away from the engine, and reinstall choke knob on mounting pin.

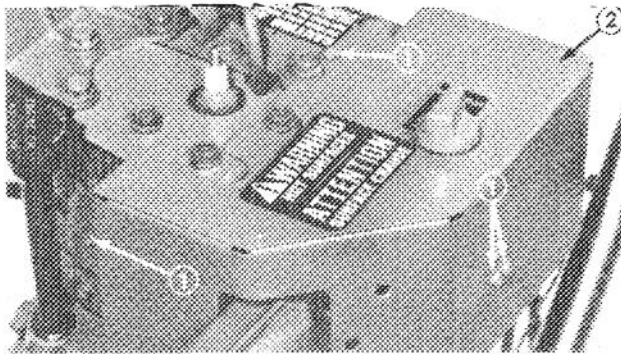

Figure 19

1. Phillips screws 2. Heater box

**IMPORTANT:** Check auger and impeller to assure that both parts are not frozen solid, but free to rotate. Also, make sure discharge chute is not obstructed.

1. Move auger drive control to DISENGAGE (Fig. 20).
2. Move wheel drive control to N—neutral— and throttle to FAST (Fig. 20).

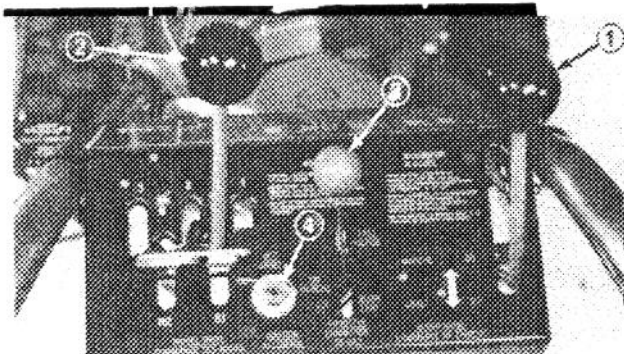

Figure 20

1. Auger drive control 3. Throttle  
2. Wheel drive control 4. Ignition switch

3. Open fuel shut-off valve below fuel tank.
4. Move choke to full choke position (Fig. 21).

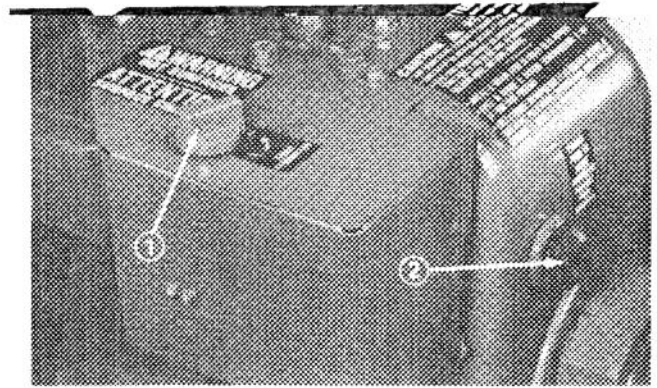

Figure 21

1. Choke  
2. Primer

5. Rotate ignition key to ON (Fig. 20).
6. Depress primer (Fig. 21) five times.
7. Grasp recoil starter handle (Fig. 22) and pull it out slowly until positive engagement results; then pull vigorously to start the engine. Keep firm grip on starter handle and return the rope slowly.

**Note:** If engine does not start or if temperature is -10° F or below, additional priming will usually be required.

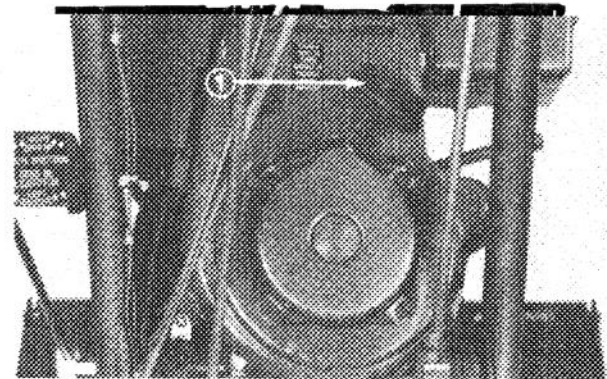

Figure 22

1. Recoil starter handle

8. After engine starts, immediately move choke (Fig. 21) to 3/4 position. As engine warms up, move choke to 1/2 position; then to OFF position. If engine falters, return choke to 1/2 position. When engine warms sufficiently, move choke to OFF position.

## TO STOP ENGINE:

1. Move wheel drive control to N—neutral—and auger drive control to DISENGAGE.
2. Move throttle to slow and rotate ignition key to OFF.



# OPERATING INSTRUCTIONS

## FREE WHEELING OR SELF PROPELLED DRIVE

The snowthrower can be free wheeled or engaged for self propelled operation. When axle pins are through outer axle holes (Fig. 16), snowthrower will free wheel. By contrast, when both pins are installed through holes in wheel hub and inner hole of axle (Fig. 16), snowthrower will self propel itself.

## CHECKING SAFETY INTERLOCK SYSTEM

The safety interlock system grounds out and stops the engine through a series of switches (Fig. 23), if the operator releases interlock levers before moving wheel drive control to N — neutral — and auger drive control to DISENGAGE. So, to keep engine running when wheel drive is in gear or when auger drive control is ENGAGED, the safety interlock lever (Fig. 23) must be compressed against handle grip. This system also prevents the operator from starting the engine with the wheel drive control in gear or auger drive control engaged.



### DANGER

If interlock system does not operate properly, have the interlock system repaired immediately by an Authorized TORO Service Dealer. **DO NOT TRY TO DEFEAT THE INTERLOCK SYSTEM BY DISCONNECTING WIRES OR SWITCHES, OR IN ANY OTHER WAY MAKE IT INOPERATIVE.** An inoperative interlock system will allow the auger and impeller to rotate continuously when the operator's position is left, and this situation is **HAZARDOUS**. Check the interlock system every time snowthrower is used.

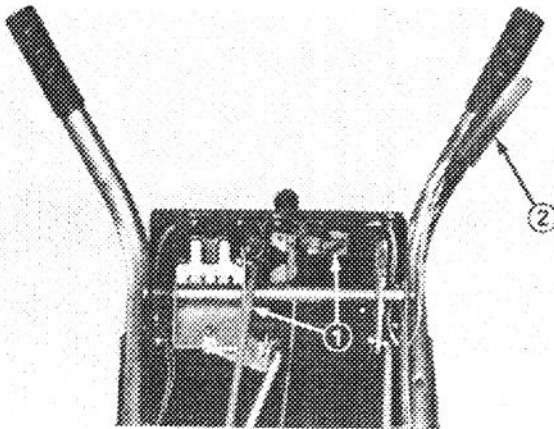

Figure 23

1. Switch
2. Interlock lever

To check interlock system:

1. Push snowthrower outdoors onto a flat, open area. Start the engine; refer to Starting and Stopping Instructions, page 12.
2. Slowly move auger drive control to ENGAGE while interlock lever is fully released. Engine should begin to shut off; and when it does, immediately move auger drive control back to DISENGAGE. If engine begins to shut off, switch is operating correctly.
3. Slowly, move wheel drive control to 1 — 1st gear — while interlock lever is fully released. Engine should begin to shut off; and when it does, immediately move wheel drive control back to N — neutral. If engine begins to shut off, switch is operating correctly.

## SNOWTHROWING TIPS

1. When snowthrower is not being used, close fuel shut-off valve, have wheel drive control in N — neutral position, auger drive control in DISENGAGE position, and key removed from the switch.
2. Remove snow as soon as possible after it falls. This will produce best snow removal results.
3. If snow will be removed from crushed rock or gravel areas, adjust skids so bottom of auger housing clears the rocks: refer to Adjusting Skids, page 16.
4. For concrete or asphalt surfaces, adjust skids so there is 1/8 inch (3 mm) between bottom of auger and concrete or asphalt surface.
5. The snowthrower is designed to clean snow down to the contact surface, but there are times when front of snowthrower may tend to ride up. If this happens, reduce forward speed by shifting into a lower gear. If front still tends to ride up, lift up on both handles to hold down front of snowthrower.
6. Discharge snow downwind whenever possible, and overlap each swath to assure complete snow removal. If wheels slip, shift into a lower gear which reduces forward speed.
7. Normally, chains are not required; however, tire chains are recommended when the wheels spin excessively.
8. In some snow and cold weather conditions, some controls and moving parts may freeze solid. Therefore, when any control becomes hard to operate, stop the engine; then check all parts for freeze up. **DO NOT USE EXCESSIVE FORCE AND TRY TO OPERATE THE CONTROLS WHEN FROZEN.** Free all controls and moving parts before operating.

# MAINTENANCE



## CAUTION

To prevent accidental starting of the engine while performing maintenance, rotate ignition key to off and remove it from the switch. Next, pull high tension wire off spark plug (Fig. 24) and make sure wire does not accidentally touch the plug.

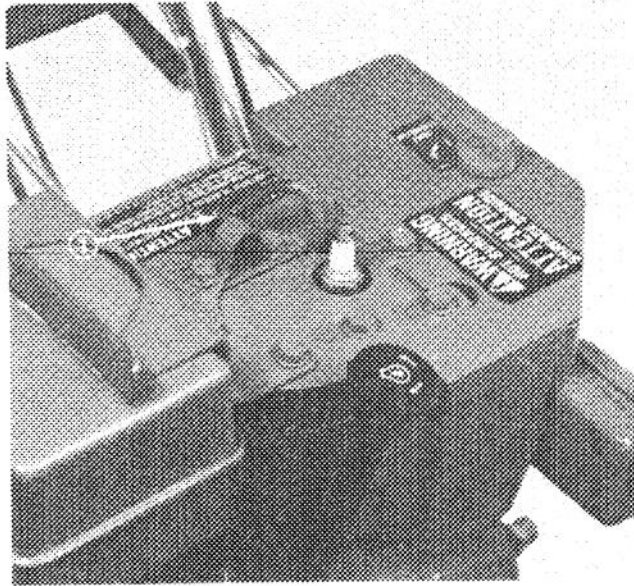

Figure 24

1. High tension wire

## DRAINING GASOLINE

1. Close fuel shut off valve located under engine (Fig. 25).
2. Place a clean drain pan under shut off valve.
3. Loosen hose clamps securing fuel line to valve and slide line off valve. (Fig. 25)



## CAUTION

Since gasoline is highly flammable, drain it outdoors and make sure engine is cool to prevent a potential fire hazard. Wipe up any gasoline that may have spilled. Do not drain gasoline near any open flame or where gasoline fumes may be ignited by a spark. Do not smoke a cigar, cigarette, or a pipe when handling gasoline.

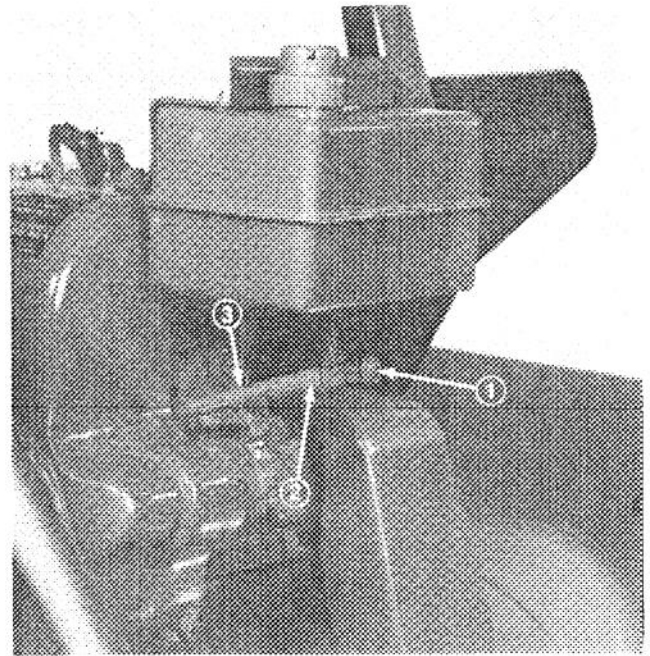

Figure 25

1. Fuel shut off valve
2. Hose clamp
3. Fuel line

4. Open valve allowing fuel to flow into drain pan.
5. Reinstall fuel line and secure with hose clamp.

## LUBRICATING SNOWTHROWER

Lubricate the control linkage and other moving parts of the snowthrower after every 15 hours of operation.

1. Lubricate pivot points in the control linkage with a few drops of SAE 10W-40 oil (Figs. 26 and 27). Wipe up any excess oil.

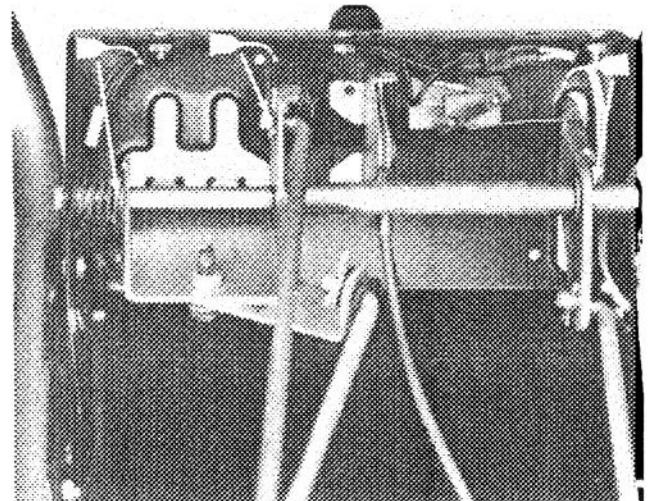

Figure 26

# MAINTENANCE

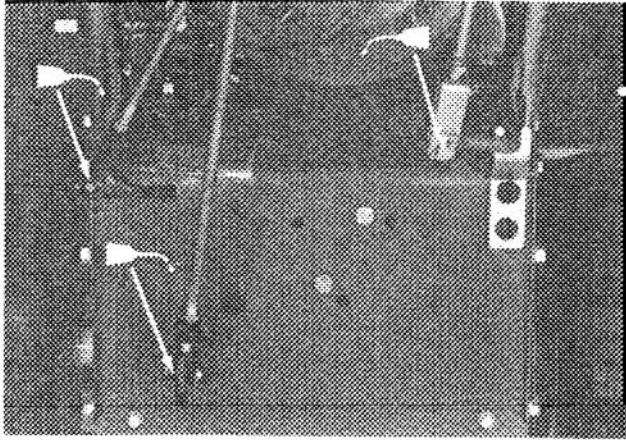

Figure 27

2. Drain gasoline from fuel tank: refer to Draining Gasoline, page 14.
3. Tip snowthrower forward onto auger housing and block it so it cannot fall.
4. Remove four thread forming screws holding rear shield in place, and slide shield away from traction unit.
5. Lightly lubricate drive chains, sprocket bushing, nylon ring, hex shaft, and the other pivot points with SAE 10W40 (Fig. 28).
6. Wipe up any excess oil and install rear shield with four thread forming screws.

**IMPORTANT: Do not get oil on rubber wheel or friction drive plate because the wheel will slip and the rubber may deteriorate.**

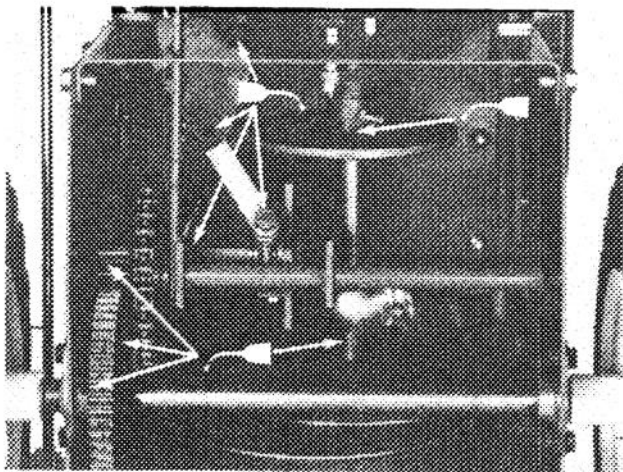

Figure 28

## CHANGING CRANKCASE OIL

Initially, change oil after the first 2 hours of engine operation; thereafter, change oil after every 25 hours of engine operation. If possible, run engine just before changing oil because warm oil flows better and carries more contaminants than cold oil.

**Note:** Drain oil when fuel tank is empty to prevent spilling gasoline.

1. Pull high tension wire off spark plug and make sure wire does not contact plug accidentally.
2. Put a two inch (51 mm) block under the right wheel so snowthrower is tipped slightly to the side. This will assure that all oil drains from crankcase.
3. Clean area around oil drain cap. Next, slide oil drain pan below drain extension; then remove oil drain cap (Fig. 29).

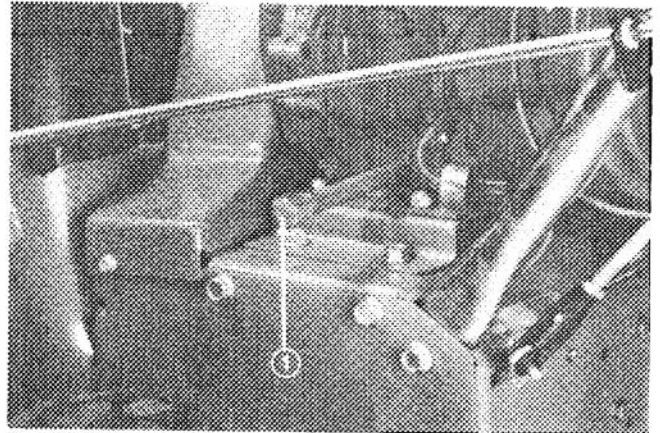

Figure 29

1. Drain cap

4. After all oil is drained, install oil drain cap. Also, REMOVE BLOCK FROM UNDER RIGHT WHEEL.
5. Position snowthrower on a level surface. Next, fill crankcase with oil: use Fill Crankcase With Oil, page 9. Wipe up any oil that may have spilled.

## CHANGING AUGER GEAR BOX OIL

Change auger gear box oil once a year. If possible, run the auger just before changing oil because warm oil flows better and carries more contaminants than cold oil.

1. Drain gasoline from fuel tank. Wipe up any spilled gas.
2. Position snowthrower on a level surface.
3. Clean area around pipe plug (Fig. 30) so dirt is removed.
4. Put a drain pan below front of auger gear box and remove pipe plug (Fig. 30): refer to Check Auger Gear Box Oil, page 9.
5. Tip snowthrower forward and hold it up until all oil drains from the gear box.



# MAINTENANCE

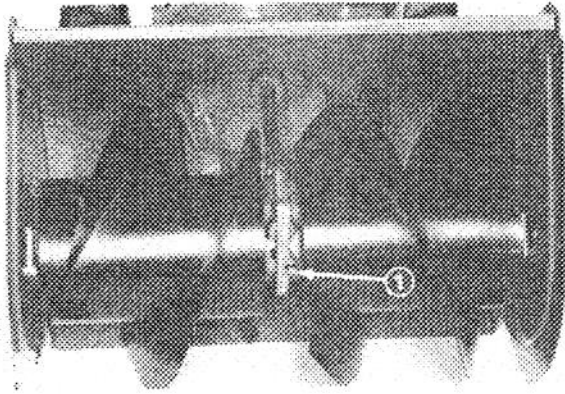

Figure 30  
1. Pipe plug

6. Carefully let snowthrower down to its normal position. Make sure it is on a level surface. Next, fill auger gear box with 3 ounces (89 ml) of SAE 90 EP transmission oil, or fill to point of overflow.
7. Install pipe plug in gear box (Fig. 30).

## ADJUSTING SKIDS

When snowthrower will be used on concrete or asphalt surfaces, adjust skids using steps 1 - 3. However, use only step 4 when snowthrower will be used on gravel or crushed rock surfaces.

1. Move snowthrower to a level surface. Next, loosen four flange nuts (Fig. 31) securing both skids to auger side plates. Skids must slide up and down.

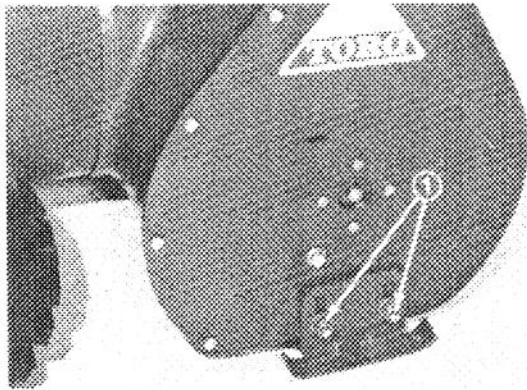

Figure 31  
1. Flange nuts

2. Push snowthrower forward so pivoting scraper blade moves backward.
3. Adjust both skids so there is 1/8 of an inch between bottom of auger and level surface. When skids are adjusted correctly, tighten flange nuts. Next, check pivoting scraper blade that is mounted at bottom of auger housing. Scraper must be parallel with level surface. If scraper is not parallel,

adjust skids again. Do not use step 4 after adjusting skids for hard surfaces.

4. Loosen four flange nuts (Fig. 31) securing both skids to auger side plates. Next, slide skids down as far as possible so auger is as far from the level surface as skid adjustment allows; then tighten flange nuts.

## REPLACING TRACTION DRIVE BELT

When traction drive belt (Fig. 32) becomes worn, stretched, oil-soaked, or otherwise defective, belt replacement is required.

1. Pull high tension wire (Fig. 32) off spark plug and make sure it does not contact the plug accidentally.
2. Remove two thread forming screws holding belt cover in place, and set belt guard aside.
3. Move auger drive control to DISENGAGE and wheel drive control to N, neutral. Next, remove auger drive belt from engine pulley and large auger/impeller pulley (Fig. 32).
4. Loosen two capscrews (Fig. 32) securing traction idler arm to front of engine. Next, remove traction drive belt from engine pulley and large traction pulley (Fig. 32).
5. Install new belt around large traction pulley (Fig. 32). Next, loop belt over engine pulley, making sure that belt is on inside of traction idler pulley and wire belt guide (Fig. 32).
6. Install new belt around large auger/impeller pulley (Fig. 32). Next, loop belt over engine pulley, making sure that belt is on inside of auger/impeller, idler pulley and wire belt retainer (Fig. 32). Slide idler arm and pulley assembly against belt to remove belt slack and tighten capscrews.

**Note:** Tension belt only enough to remove slack. Do not over-tension.

7. Install belt cover with two thread forming screws.
8. Install high tension lead and test operate unit to check traction. If little or no traction is evident, proceed to step 9. If traction operation is satisfactory, proceed to operate machine.
9. Remove high tension lead from spark plug and remove belt guard. Loosen two capscrews securing traction idler arm and slide idler arm and pulley assembly further against belt. Move assembly a minimal amount to assure belt is not over tensioned.



# MAINTENANCE

10. Repeat step 8.

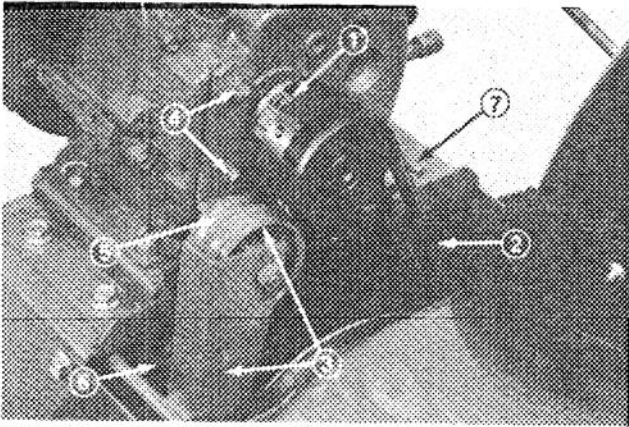

Figure 32

- |                                  |                          |
|----------------------------------|--------------------------|
| 1. Traction drive belt           | 4. Cap screws            |
| 2. Auger/impeller drive belt     | 5. Traction idler pulley |
| 3. Auger/impeller pulley & idler | 6. Traction pulley       |
|                                  | 7. Belt guide            |

## REPLACING AUGER/IMPELLER DRIVE BELT

When auger/impeller drive belt (Fig. 32) becomes worn, stretched, oil-soaked, or otherwise defective, belt replacement is required.

1. Pull high tension wire (Fig. 24) off spark plug and make sure it does not contact the plug accidentally.
2. Remove two thread forming screws holding belt cover in place, and set belt guard aside.
3. Move auger drive control to DISENGAGE and wheel drive control to N, neutral. Next, remove auger drive belt from engine pulley and large auger/impeller pulley (Fig. 32).
4. Install new belt around large auger/impeller pulley (Fig. 32). Next, loop belt over engine pulley, making sure that belt is on inside of idler pulley and wire belt guide (Fig. 32).
5. Install belt cover with two thread forming screws.

## ADJUSTING AUGER/IMPELLER DRIVE BELT

If auger slips, which means the auger drive belt is slipping, an adjustment is required. When a new auger/impeller drive belt is installed, an adjustment may also be required.

1. Loosen jam nut from clevis at bottom of auger drive control rod (Fig. 33). Next, remove cotter pin and clevis pin holding clevis to bent rod (Fig. 33).
2. Rotate clevis (Fig. 33) counterclockwise – out – to increase belt tension. By contrast, rotate clevis clockwise – in – to decrease belt tension.

**Note:** When adjusting clevis, rotate it one complete – 360° – turn.

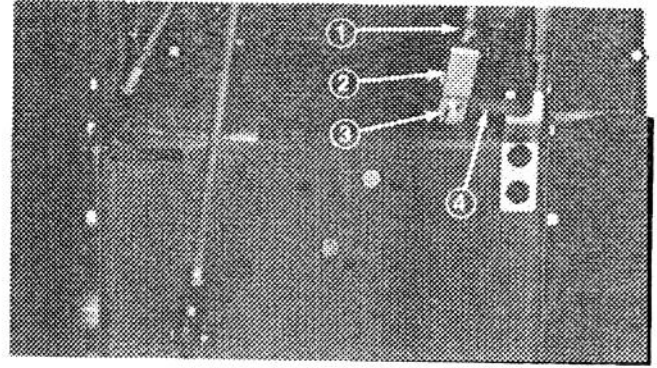

Figure 33

- |            |                            |
|------------|----------------------------|
| 1. Jam nut | 3. Clevis pin & cotter pin |
| 2. Clevis  | 4. Bent rod                |

3. Connect clevis to bent rod with clevis pin and cotter pin (Fig. 33). Next, tighten jam nut against top of clevis (Fig. 33).

4. Check tension of belt by operating the auger. If belt still slips, adjust clevis again.

**IMPORTANT:** Do not adjust belt too tight because the belt will wear out quickly or possibly cause damage to the snowthrower.

## ADJUSTING TRACTION DISC

If snowthrower does not drive in reverse or forward speeds, or if snowthrower does not disengage – come out of gear – an adjustment is required.

1. Drain gasoline from fuel tank. Next, remove high tension wire from spark plug and make sure it does not contact plug accidentally.
2. Tip snowthrower forward onto auger housing, and block the unit so it cannot fall accidentally.
3. Remove four thread forming screws securing rear shield in place, and slide shield away from traction unit.
4. Move wheel drive control to N, neutral position.
5. Top and bottom surface of rubber drive wheel must be an equal distance from the friction disc and pulley (Fig. 34). If distance is the same and traction control does not function properly, contact your local authorized Toro service dealer. If distance is not the same, proceed to step 6.
6. Loosen jam nut from clevis at bottom of longest wheel drive control rod (Fig. 35). Next remove cotter pin and clevis pin holding clevis to link arm (Fig. 35). If rubber drive wheel is too close to the front pulley, lengthen the rod by rotating clevis (Fig. 35) one full turn counterclockwise. By contrast, if rubber drive wheel is too close to the rear friction disc, shorten the rod by rotating clevis (Fig. 35) one full turn clockwise.
7. Connect clevis to link arm with clevis pin. Next, move wheel drive control to 1, first gear;

# MAINTENANCE

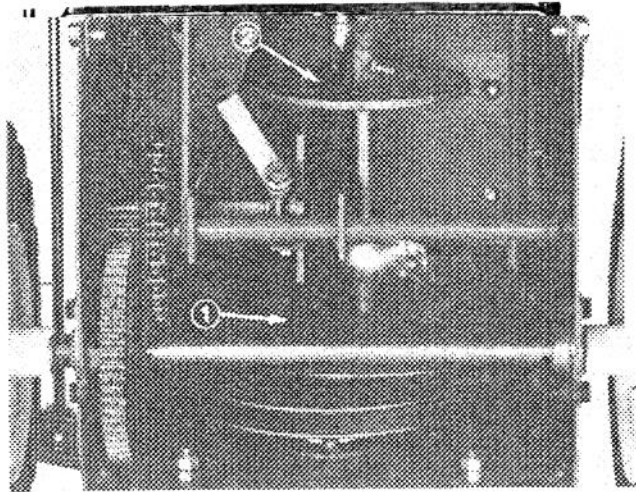

Figure 34

1. Front pulley
2. Rear friction disc

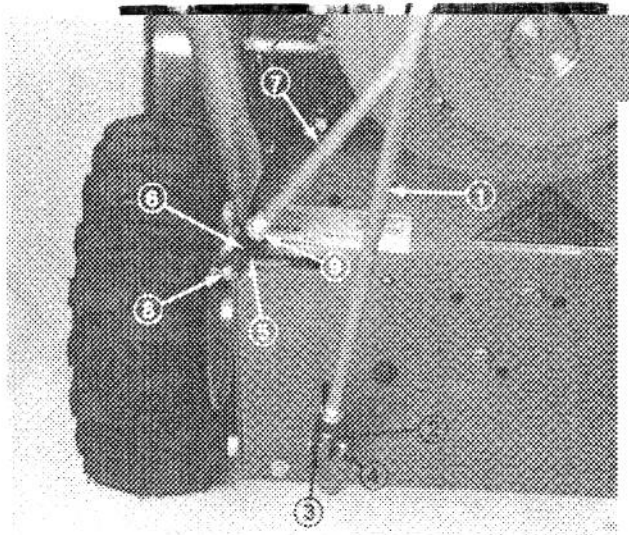

Figure 35

1. Long rod
2. Clevis
3. Link arm
4. Clevis pin & cotter pin
5. Shift arm
6. Clevis
7. Short rod
8. Clevis pin & cotter pin
9. Jam nut

then check rubber drive wheel for correct adjustment by repeating step 5.

8. Move wheel drive control to N, neutral. Next, connect clevis to link arm with clevis pin and cotter pin (Fig. 35). Also, tighten jam nut against top of clevis (Fig. 35). Lastly, install rear shroud with four thread forming screws, and move snowthrower back to its normal position.

## REPLACING SPARK PLUG

Correct spark plug to use in a Champion RJ-17LM or Autolite AR7N, and correct air gap is 0.030 of an inch (0.76 mm). Since air gap between center and side electrodes of the spark plug increases gradually during normal engine operation, install a new plug after every 25 hours of engine operation.

1. Clean area around spark plug so foreign matter cannot fall into cylinder when plug is removed.
2. Pull high tension wire off spark plug (Fig. 36), and remove plug from cylinder head.

**IMPORTANT:** A cracked, fouled, or dirty spark plug must be replaced. Do not sand blast, scrape, or clean electrodes because grit may eventually release from the plug and fall into the cylinder. The result will likely be engine damage.

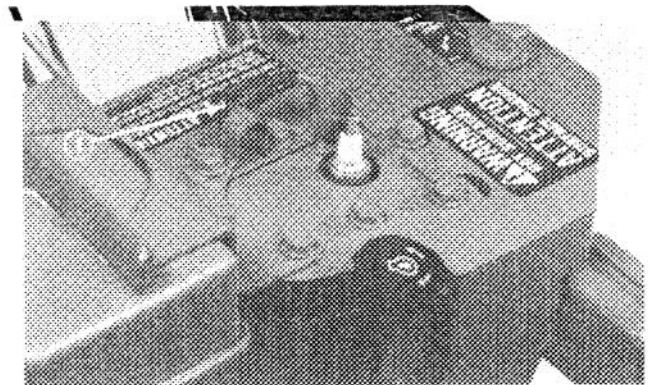

Figure 36

1. High tension wire

3. Set air gap between electrodes of new spark plug at 0.030 of an inch (0.76 mm) (Fig. 37). Next, install spark plug in cylinder head. Tighten plug to 15 ft-lb (20.4 N·m). If torque wrench is not used, tighten plug firmly.

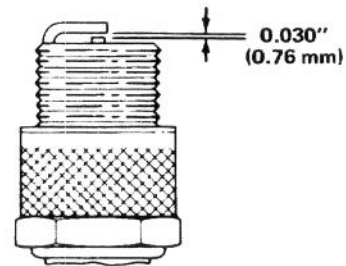

Figure 37

4. Push the high tension wire onto spark plug (Fig. 36).

## ADJUSTING CARBURETOR

The carburetor has been adjusted at the factory, but an occasional adjustment may be required. However, do not make unnecessary carburetor adjustments because factory settings are usually satisfactory.

1. Remove carburetor heater box: use Starting and Stopping Instructions, paragraph one, steps A & B, page 12.

**IMPORTANT:** Do not close power adjusting screw too tight because the screw and seat will likely be damaged.

# MAINTENANCE

2. Power Adjusting Screw (Fig. 38) — Close screw by gently rotating it clockwise until a slight seating resistance is felt. Next, rotate power adjusting screw 1 full turn — 360° — counterclockwise.

**IMPORTANT:** Do not close idle mixture screw too tight because the screw and seat will likely be damaged.

3. Idle Mixture Screw (Fig. 38) — Close screw by gently rotating it clockwise until a slight seating resistance is felt. Next, rotate idle mixture screw 1-1/2 full turns counterclockwise.

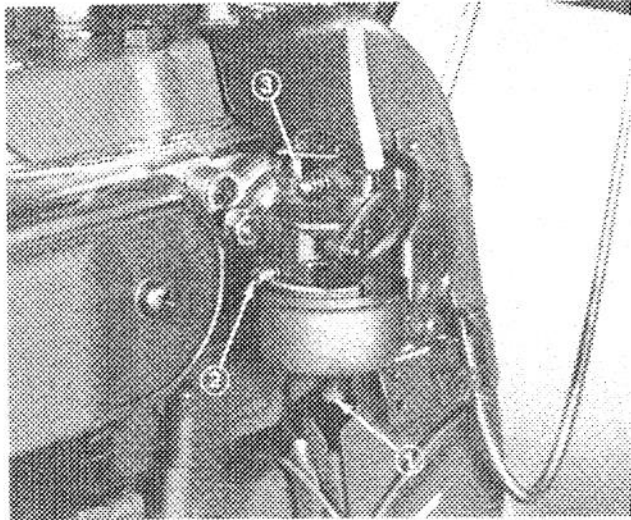

Figure 38

1. Power adjusting screw 2. Idle mixture screw 3. Idle speed screw

**Note:** The settings for the power adjusting screw and the idle mixture screw are approximate; however, these settings will allow engine to be started so carburetor can be fine tuned — steps 4-7.

4. Start engine and let it warm up for approximately 3 to 5 minutes; then move throttle to FAST.



Engine must be running so final adjustment of the carburetor can be performed. To guard against possible personal injury, move auger drive and wheel drive controls to DISENGAGE, and remember to keep hands, feet, face, and other parts of the body away from muffler, auger, discharge chute, and any moving part(s).

5. Rotate power adjusting screw (Fig. 38) clockwise — in — 1/8 turn at a time until engine misses because of a lean gasoline mixture. Then rotate screw counterclockwise — out — 1/8 turn at a time until engine runs unevenly because of a rich gasoline mixture. Next, rotate power adjusting screw clockwise, back to the midpoint between the rich and lean setting so engine runs smoothly.

**Note:** Wait several seconds between each 1/8 turn setting so engine can adjust to the new fuel mixture.

6. Move throttle backward to idle speed. Next, rotate idle speed screw (Fig. 38) until engine idles fast — 1750 rpm.

7. Rotate idle mixture screw (Fig. 38) clockwise — in — 1/8 turn at a time until engine begins to miss because of a lean mixture. Then rotate screw counterclockwise — out — 1/8 turn at a time until engine runs unevenly because of rich mixture. Next, rotate idle mixture screw clockwise, back to the mid-point between rich and lean setting.

**Note:** Wait several seconds between each 1/8 turn setting so engine can adjust to the new fuel mixture.

8. Again, rotate idle speed screw (Fig. 38) until engine idles at 1750 rpm.

9. Check carburetor adjustment by quickly moving throttle from low speed to high speed. Engine should accelerate without hesitation or sputtering. If engine does not accelerate properly, adjust carburetor to a slightly richer mixture. Also, if engine falters under load, open power adjusting screw 1/8 turn counterclockwise.

10. After carburetor is adjusted, shut engine off.

## PREPARING SNOWTHROWER FOR STORAGE

1. Drain gasoline from fuel tank: refer to Draining Gasoline, page 14. Wipe up any gasoline that may have spilled.

2. Start the engine and let it run until it stops because there is no gasoline in the fuel system. When engine sputters, push choke down so fuel in carburetor is expended.

3. Remove spark plug from cylinder head. Next, pour two teaspoons of SAE 30 engine oil into spark plug hole in cylinder head. Install spark plug in cylinder head, but do not install high tension wire on the plug. Then pull recoil starter slowly to distribute oil on inside of cylinder.

4. Lubricate the snowthrower: refer to Lubricating Snowthrower, page 14. Change crankcase oil: use Changing Crankcase Oil, page 15.

5. Clean the snowthrower. Touch up chipped surfaces with paint. Sand affected areas before painting, and use a rust preventative to prevent metal parts from rusting.

6. Tighten all screws and nuts. If any part is damaged, repair or replace it.

7. Store snowthrower in a clean, dry place, and cover it to give protection.

8. If snowthrower is equipped with the optional drift breaker storage bar, the snowthrower may be stored in upright position. Make sure to drain gas before tipping snowthrower upright on auger housing.















# THE TORO PROMISE

It is Toro's policy to design and produce TORO products to provide our customers with a high level of performance and durability in normal operation. Our products, however, are produced in high volume, and it is inevitable that occasionally a unit will reach a customer with a defect in materials or workmanship which causes the unit to fall below the normal high

level of TORO performance. Invariably, such a defect will be noticed in a residential product within one year after purchase. Recognizing this possibility, Toro has established a simple guarantee policy and procedure that is intended to assure customer satisfaction. This guarantee statement is as follows:

## The Toro Promise

*A One Year Limited Warranty  
On All*

*Gas Snowthrowers, Gas Trimmers, Promotional Rotary Mowers,  
Debris Equipment, and Generators.*

*The Toro Company promises to repair these TORO Products if defective in materials or workmanship. The following time periods from the date of purchase apply:*

Residential Product . . . . . 1 Year  
Residential Products Used Commercially . . . . . 45 Days

*The costs of parts and labor are included, but the customer pays the transportation costs. Just return any residential product to an Authorized TORO Service Dealer or TORO Distributor.*

Should you feel your TORO is defective and wish to rely on The Toro Promise, the following procedure is recommended:

1. Contact any Authorized TORO Service Dealer, TORO Master Service Dealer, or TORO Distributor (the Yellow Pages of your telephone directory is a good reference source).
2. He will either instruct you to return the product to him or recommend another Authorized TORO Service outlet which might be more convenient.
3. Bring the product along with your original sales slip, or other evidence of purchase date, to the service dealer.
4. The servicing dealer will inspect the unit, advise you whether the product is defective and, if so, make all repairs necessary to correct the defect without extra charge to you.

If for any reason you are dissatisfied with the dealer's analysis of the defect or the service performed, you may contact us.

Write:  
Toro Customer Service Department  
8111 Lyndale Avenue South  
Minneapolis, Minnesota 55420

The above remedy of product defects through repair by an Authorized TORO Service Dealer is the purchaser's sole remedy for any defect.

THERE IS NO OTHER EXPRESS WARRANTY. ALL IMPLIED WARRANTIES OF MERCHANTABILITY AND

FITNESS FOR USE ARE LIMITED TO THE DURATION OF THE EXPRESS WARRANTY.

Some states do not allow limitation on how long implied warranty lasts, so the above limitation may not apply to you.

This Warranty applies only to parts or components which are defective and does not cover repairs necessary due to normal wear, misuse, accidents, or lack of proper maintenance. Regular, routine maintenance of the unit to keep it in proper operating condition is the responsibility of the owner.

All warranty repairs reimbursable under The Toro Promise must be performed by an Authorized TORO Service Dealer using Toro approved replacement parts.

Repairs or attempted repairs by anyone other than an Authorized TORO Service Account are not reimbursable under The Toro Promise. In addition, these unauthorized repair attempts may result in additional malfunctions, the correction of which is not covered by warranty.

The Toro Company is not liable for indirect, incidental or consequential damages in connection with the use of the product including any cost or expense of providing substitute equipment or service during periods of malfunction or non-use.

Some states do not allow the exclusion of incidental or consequential damages, so the above exclusion may not apply to you.

This warranty gives you specific legal rights, and you may also have other rights which vary from state to state.