



MODEL NO. 30223 — 20001  
THRU 30001 & UP

**OPERATOR'S  
MANUAL**

**GROUNDMASTER® 223D**  
TRACTION UNIT



The GROUNDMASTER 223D conforms to the American National Standards Institute's safety standards for riding mowers; thus Toro proudly displays the ANSI safety seal.

To assure maximum safety, optimum performance, and to gain knowledge of the product, it is essential that you or any other operator of the mower read and understand the contents of this manual before the engine is ever started. Pay particular attention to the SAFETY INSTRUCTIONS highlighted by this symbol —



The safety alert symbol means CAUTION, WARNING or DANGER — personal safety instruction. Failure to comply with the instruction may result in personal injury.



# FOREWORD

The GROUNDMASTER 223D was developed to satisfy the demand for a maneuverable, intermediate size, turf maintenance rotary mower. The machine has advanced concepts in engineering, design and safety; and if maintained properly, it will give excellent service.

Since the GROUNDMASTER 223D is a high quality product, Toro is concerned about the future use of the machine and the safety of the user. Read this manual to familiarize yourself with the proper set up, operation, and maintenance instructions. The major sections of this manual are:

1. Safety Instructions
2. Set Up Instructions
3. Before Operating
4. Operating Instructions
5. Maintenance

Certain information in this manual is emphasized. DANGER, WARNING and CAUTION identify personal safety related information. IMPORTANT identifies mechanical information demanding special attention. Be sure to read the directive because it deals with the possibility of damaging a part or parts of the machine. NOTE identifies general information worthy of special attention.

If help concerning set up, operation, maintenance or safety is ever needed, contact a local Authorized Toro Distributor. In addition to genuine Toro replacement parts, the distributor also has optional equipment from the complete line of Toro turf care equipment. Keep your Toro all TORO — buy genuine Toro replacement parts and accessories.

## SPARK ARRESTOR

Because in some areas there are local, state or federal regulations requiring that a spark arrestor muffler be used on the engine of this mower, a spark arrestor muffler is available as an option. If a spark arrestor muffler is required, order the following part from your Authorized Toro Distributor:

(1) 75-6880 Spark Arrestor Screen

This part is certified to meet the requirements of USDA Forest Service Standard No. 5100-1A.

When mower is used or operated on any California forest, brush or grass covered land, a working order spark arrestor muffler must be attached. If not, the operator is violating state law, section 4442 Public Resources code.

## SERVICE MANUAL

A Service Manual is available for the Groundsmaster 223-D. This publication provides information for troubleshooting, adjusting, testing and repair of major systems and components on the machine. To order this publication, contact your authorized Toro Distributor. Ask for Form 88-712-SL, Groundsmaster 220-D Service Manual.

# TABLE OF CONTENTS

	Page		Page
SAFETY INSTRUCTIONS .....	3-5	BRAKE MAINTENANCE .....	20
SAFETY AND INSTRUCTION DECALS .....	6	Adjusting Service Brakes .....	20
SPECIFICATIONS .....	7-8	AIR CLEANER MAINTENANCE .....	21-22
LOOSE PARTS .....	8	General Maintenance Practices .....	21
SET-UP INSTRUCTIONS .....	8-10	Servicing Dust Cup and Baffle .....	21
Install Steering Wheel .....	8	Servicing Air Cleaner Filter .....	21
Installing Optional Seat .....	8	Inspecting Filter Element .....	22
Installing Optional Adjustable		ENGINE MAINTENANCE .....	22-25
Suspension Seat .....	9	Cleaning Radiator and Screen .....	22
Connect Battery .....	10	Changing Crankcase Oil and Filter .....	22
Check Tire Pressure .....	10	Servicing Fuel System .....	22
BEFORE OPERATING .....	11-13	Bleeding Air from Injectors .....	24
Check Crankcase Oil .....	11	Servicing Engine Belts .....	24
Check Cooling System .....	11	PTO Belt .....	25
Check Hydraulic System Fluid .....	12	PTO Clutch Adjustment .....	25
Fill Fuel Tank with Diesel Fuel .....	12	Changing Coolant in Cooling System .....	26
CONTROLS .....	14-15	ELECTRICAL MAINTENANCE .....	26
OPERATING INSTRUCTIONS .....	16-18	Servicing Battery .....	26
Starting/Stopping Engine .....	16	Wiring Harness Service .....	26
Bleeding Fuel System .....	16	HYDRAULIC SYSTEM MAINTENANCE .....	27
Checking Operation of Interlock Switches .....	17	Adjusting Transmission for Neutral .....	27
Operating Characteristics .....	17	Changing Hydraulic Oil and Filter .....	27
Pushing or Towing Traction Unit .....	18	PRODUCT IDENTIFICATION .....	28
LUBRICATION MAINTENANCE .....	18-19	PREPARATION FOR SEASONAL STORAGE .....	28
Greasing Bearings and Bushings .....	18	SERVICE INTERVAL CHART .....	30-31
		THE TORO PROMISE .....	Back Cover

## SAFETY INSTRUCTIONS



The GROUNDMASTER 223D was tested and certified by TORO for compliance with the B71.4—1984 specifications of the American National Standards Institute. Although hazard control and accident prevention partially are dependent upon the design and configuration of the machine, these factors are also dependent upon the awareness, concern, and proper training of the personnel involved in the operation, transport, maintenance, and storage of the machine. Improper use or maintenance of the machine can result in injury or death. To reduce the potential for injury or death, comply with the following safety instructions.

**WARNING:** Engine exhaust contains carbon monoxide which is an odorless, deadly poison. Carbon monoxide is also known to the State of California to cause birth defects. Do not run engine indoors or in an enclosed area.

### BEFORE OPERATING

1. Read and understand the contents of this Operator's Manual before starting and operating the machine. Become familiar with all controls and how to stop quickly. A replacement manual is available by sending complete Model and Serial Number to:

The Toro Company  
8111 Lyndale Avenue South  
Minneapolis, Minnesota 55420

2. Never allow children to operate the machine. Do not allow adults to operate the machine without proper instruction. Only trained operators who have read this manual should operate this machine.

3. Never operate the machine when under the influence of drugs or alcohol.

4. Remove all debris or other objects that might be picked up and thrown by cutter blades or fast moving components from other attached implements. Keep all bystanders away from the operating area.

5. Keep all shields and safety devices in place. If a shield, safety device or decal is malfunctioning or damaged, repair or replace it before operation is commenced. Also, tighten loose nuts, bolts and screws to make sure machine is in safe operating condition.

# SAFETY INSTRUCTIONS

6. Do not operate machine while wearing sandals, tennis shoes, sneakers or shorts. Also, do not wear loose fitting clothing because it could get caught in moving parts. Always wear long pants and substantial shoes. Wearing safety glasses, safety shoes and a helmet is advisable and required by some local ordinances and insurance regulations.

7. Check interlock switches daily for proper operation (Refer To Checking Interlock Switches, Page 17). Do not rely entirely on safety switches — shut off engine before getting off seat. If a switch fails, replace it before operating the machine. The interlock system is for your protection, so do not bypass it. Replace all interlock switches every two years. Interlock switches should be adjusted so:

- A. Engine cannot be started unless traction pedal is released (neutral position) — and PTO lever is DISENGAGED (off position).
- B. Engine stops if operator gets off seat when traction pedal is depressed.
- C. Engine stops if operator gets off seat when PTO lever is ENGAGED (on position).

8. Grass deflectors must be installed in lowest position on side discharge units.

9. Fill fuel tank with diesel fuel before starting the engine. Avoid spilling any fuel. Since fuel is highly flammable, handle it carefully — DO NOT SMOKE.

- A. Use an approved container.
- B. Do not fill tank while engine is hot or running.
- C. Do not smoke while handling diesel fuel.
- D. Fill fuel tank outdoors and to about one inch (25 mm) from top of the tank, not the filler neck.
- E. Wipe up any spilled fuel. Install fuel container cap and machine fuel tank cap securely before starting the engine.

## WHILE OPERATING

10. Do not run the engine in a confined area without adequate ventilation. Exhaust fumes are hazardous and could possibly be deadly.

11. Maximum seating capacity is one person. Never carry passengers.

12. Sit on the seat when starting the engine and operating the machine.

13. This product may exceed noise levels of 85 dB(A) at the operator position. Ear protectors are recommended for prolonged exposure to reduce the potential of permanent hearing damage.

14. Before starting the engine:

- A. Engage parking brake.
- B. Be sure traction pedal is in neutral and PTO switch is in OFF position.
- C. After engine is started, release parking brake and keep foot off traction pedal. Machine must not move. If movement is evident, the neutral return mechanism is adjusted incorrectly; therefore, shut engine off and adjust until machine does not move when traction pedal is released.

15. Using the machine demands attention, and to prevent loss of control:

- A. Mow only in daylight or when there is good artificial light.
- B. Watch for holes or other hidden hazards.
- C. Do not drive close to a sand trap, ditch, creek or other hazard.
- D. Reduce speed when making sharp turns and when turning on hillsides.
- E. Avoid sudden stops and starts.
- F. Before backing up, look to the rear to be sure no one is behind the machine.
- G. Watch out for traffic when near or crossing roads. Always yield the right-of-way.

16. Traverse slopes carefully. Do not start or stop suddenly when traveling uphill or downhill.

17. Operator must be skilled and trained in how to drive on hillsides. Failure to use caution on slopes or hills may cause loss of control possibly resulting in personal injury or death.

18. If engine stalls or machine loses headway and cannot make it to the top of a slope, do not turn machine around. Always back slowly straight down the slope.

19. The grass deflector must always be installed and in lowest position on the cutting unit. This product is designed to drive objects into the ground where they lose energy quickly in grassy areas. However, don't take an injury risk!! When a person or pet appears unexpectedly in or near the mowing area, STOP MOWING. Careless operation, combined with terrain angles, ricochets, or improperly positioned guards, can lead to thrown object injuries. Do not resume mowing until area is cleared.

20. Never raise the cutting unit or other attached implement while the blades or other parts are rotating.

21. If the cutting blades strike a solid object or the machine vibrates abnormally, turn PTO switch OFF, move throttle to SLOW, set parking brake and shut

# SAFETY INSTRUCTIONS

engine off. Remove key from ignition switch to prevent possibility of accidental starting. Check cutting unit and traction unit for damage and defective parts. Make all repairs before restarting the engine and operating the cutting unit. Make sure blades are in good condition and blade bolts are torqued to specification (See Deck Operator's Manual).

22. Do not touch engine, muffler or radiator while engine is running or soon after it is stopped because these areas could be hot enough to cause a burn.

23. Lower the cutting unit or other attached implement to the ground and remove key from ignition switch whenever machine is left unattended.

24. To stop machine, remove foot from traction pedal and use brakes. Gradually reversing the traction pedal can provide additional braking.

25. Before getting off the seat:

- A. Move traction pedal to neutral position and remove foot from pedal.
- B. Set the parking brake and turn the PTO switch OFF.
- C. Shut the engine OFF and remove key from ignition switch. Wait for all machine movement to stop before getting off the seat.

## MAINTENANCE

26. Remove key from ignition switch to prevent accidental starting of the engine when servicing, adjusting or storing the machine.

27. Perform only those maintenance instructions described in this manual. If major repairs are ever needed or assistance is desired, contact an Authorized TORO Distributor.

28. To reduce potential fire hazard, keep the engine free of excessive grease, grass, leaves and accumulations of dirt.

29. Be sure machine is in safe operating condition by keeping nuts, bolts and screws tight. Check the blade mounting bolts frequently to be sure they are torqued to proper specification (See Deck Operator's Manual).

30. Make sure all hydraulic line connectors are tight, and all hydraulic hoses and lines are in good condition before applying pressure to the system.

31. Keep body and hands away from pin hole leaks or nozzles that eject hydraulic fluid under high pressure. Use paper or cardboard, not hands, to search for leaks. Hydraulic fluid escaping under pressure can have sufficient force to penetrate skin and do serious damage. If fluid is injected into the skin it must be surgically removed within a few hours by a doctor familiar with this form of injury or gangrene may result.

32. Before disconnecting or performing any work on the hydraulic system, all pressure in system must be relieved by stopping engine and lowering implement to the ground.

33. If the engine must be running to perform a maintenance adjustment, keep hands, feet, clothing and other parts of the body away from the PTO shaft, cutting unit blades, radiator fan and other moving parts.

34. Do not overspeed the engine by changing governor settings. Maximum engine speed (with engine coupled to transmission) is 3200-3250 rpm. To ensure safety and accuracy, have an Authorized TORO Distributor check maximum engine speed with a tachometer.

35. Engine must be shut off before checking oil or adding oil to the crankcase.

36. When manufactured, the GROUNDMASTER® 223D conformed to safety standards in effect for riding mowers. Therefore, to ensure optimum performance and safety, always purchase genuine TORO® replacement parts and accessories. NEVER USE "WILL-FIT" REPLACEMENT PARTS AND ACCESSORIES MADE BY OTHER MANUFACTURERS. Using unapproved replacement parts and accessories could void the warranty of The Toro Company.

### CAUTION

1. KEEP ALL SHIELDS IN PLACE.
2. BEFORE LEAVING OPERATOR'S POSITION.
  - A. MOVE TRANSMISSION TO NEUTRAL.
  - B. SET PARKING BRAKE.
  - C. TURN PTO SWITCH OFF.
  - D. SHUT OFF ENGINE.
  - E. REMOVE IGNITION KEY.
3. WAIT FOR ALL MOVEMENT TO STOP BEFORE SERVICING MACHINE.
4. KEEP BYSTANDERS FROM AREAS BEING MOWED.
5. NEVER CARRY PASSENGERS.



# SAFETY AND INSTRUCTION DECALS

The following decals are installed on the machine. If any become damaged or illegible, replace it. The decal part number is listed below and in your parts catalog. Replacement can be ordered from your Authorized Toro Distributor.

**CAUTION**  
MAINTAIN WHEEL FASTENER TORQUE AT 45-55 ft.-lb.  
SEE OPERATORS MANUAL FOR INSTRUCTIONS. 67-1720

ON FRAME IN  
FRONT OF DRIVE WHEELS  
(Part No. 67-1720)

**CAUTION**  
CHECK PERFORMANCE OF ALL INTERLOCK SWITCHES DAILY.  
SEE OPERATOR'S MANUAL FOR INSTRUCTION. DO NOT  
DEFEAT INTERLOCK SYSTEM. IT IS FOR YOUR PROTECTION. 67-1710

SEAT FRONT PLATE  
(Part No. 67-1710)

**WARNING**  
PTO universal shaft is attached to  
traction unit. DO NOT ENGAGE PTO  
without first removing universal  
shaft or coupling it to a suitable  
implement.

TAG ON PTO SWITCH  
(Part No. 52-1420)



FRONT BULKHEAD  
(Part No. 53-4430)



RIGHT SIDE OF PLATFORM  
(Part No. 66-8890)

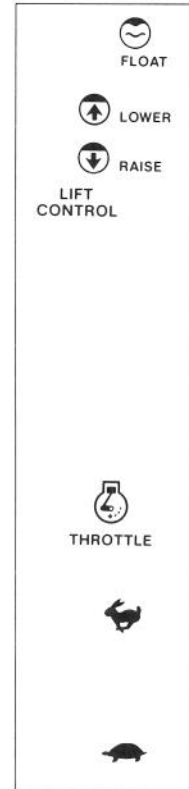

RIGHT OF SEAT  
(Part No. 66-8750)

STARTING INSTRUCTIONS (SEE OPERATOR'S MANUAL)  
1. Disengage power take-off  
2. Place traction drive in neutral position  
3. Depress brake pedal  
4. Set throttle control full open  
5. Push glow plug switch to on position and preheat  
6. Turn key to start position  
To stop: turn key to off position and remove key

**CAUTION**  
1. DISENGAGE POWER TAKE-OFF BEFORE RAISING IMPLEMENT TO TRANSPORT POSITION  
2. DO NOT OPERATE IMPLEMENT IN TRANSPORT POSITION  
3. KEEP ALL GUARDS AND COVERS IN PLACE  
4. BEFORE LEAVING OPERATOR'S POSITION:  
• MOVE TRANSMISSION TO NEUTRAL  
• SET PARKING BRAKE  
• DISENGAGE POWER TAKE-OFF  
• SHUT OFF ENGINE  
• REMOVE IGNITION KEY  
5. WAIT FOR ALL MOVEMENT TO STOP BEFORE SERVICING  
6. STOP ENGINE BEFORE ADDING FUEL OR LIFTING HOOD  
7. KEEP PEOPLE AND PETS A SAFE DISTANCE AWAY FROM MACHINE 66-8880

ON TOOL BOX  
(Part No. 66-8880)

**CAUTION**  
DO NOT USE  
STARTING FLUID.

AIR CLEANER  
(Part No. 67-1700)



ON FAN SHROUD  
(Part No. 76-8750)



NEAR FUEL CAP  
(Part No. 52-1320)



TOOL BOX REAR  
(Part No. 27-7310)

**CHECK/SERVICE**

- Oil levels (Engine/Trans.)
- Coolant level
- Tire pressure
- Belts (Fan, Alt, PTO)
- Fuel - Diesel Only
- Battery
- Grease, Lube points
- Radiator screen
- Air cleaner
- Electric clutch gap 015-030
- PTO Belt tension
- Water separator

**FILTERS PART NO.**

A. Air	27-7110
B. Fuel Pump	43-2550
C. Fuel line	63-8300
D. Trans. Oil	23-2300
E. Engine Oil	67-4330

**GM 223-D QUICK REFERENCE AID**

**FLUID SPECIFICATIONS** \*See operator's manual for initial changes.

	TYPE > 32° F 0°C	TYPE < 32° F 0°C	CAPACITY	*CHANGE INTERVALS
Engine oil	SAE 30 CD	SAE 10W-30 CD	3.9 QT. <sup>liters</sup>	50 hrs. <sup>filter</sup> 100hrs.
Trans oil	SAE 10W-30 SF, CC, CD	TYPE For FA Trans. Fluid	6 QT. <sup>liters</sup>	250 hrs. <sup>filter</sup> 250hrs.
Fuel	NO. 2 - D	NO. 1 - D	8.5 GAL. <sup>liters</sup>	— <sup>filter</sup> 400hrs.
Coolant	50/50 MIX Ethylene glycol anti-freeze/Water		7 QT. <sup>liters</sup>	2 years

84-1960

INSIDE TOOL BOX COVER  
(Part No. 84-1960)

# SPECIFICATIONS

## Engine:

Manufacturer — Mitsubishi  
Horsepower — 22 (16 Kw) @ 3000 RPM.  
Torque — 40 lb-ft (54.2 N-m) @ 2400 RPM.  
Displacement — 58.1 cu in. (952 cc).  
Crankcase Capacity — 3.8 qt. (3.6 L).  
Governor — Mechanical.  
Governor Limit — 3200-3250 RPM.  
Idle Speed — 1700 RPM.

**Air Cleaner:** Donaldson heavy duty with precleaner. Remote mounted.

**Fuel Tank Capacity:** 8.5 gal. (32 l).

**Fuel Filter/Water Separator:** 3 micron spin-on type element. Replaceable (Toro Part No. 63-8300).

**Fuel Pump:** 12 volt electric (transistor type) w/replaceable fuel filter (Toro Part No. 43-2550).

## Cooling System:

Radiator — Approx. 6 qt (5.7 l) capacity.  
Expansion Tank — Remote mounted; 1 qt (0.946 l) capacity. System contains a 50/50 mix of ethylene glycol anti-freeze and water.

**Electrical:** Battery — 12 volt, BCI group size 26, 530 Amp at 0° F. 35 amp alternator with regulator/rectifier.

**Drive Coupling:** Transmission driven by steel shaft with flexible rubber couplings at each end.

## Transmission:

Manufacturer & Type — Sundstrand hydrostatic, Type U15.  
Normal Charge Pressure — 70-150 psi (483-1034 kPa).  
Implement Relief Setting — 700-800 psi (4 826 - 5 516 kPa).

**Hydraulic Filter:** 25 micron mounted directly to transmission. Replaceable (Toro Part No. 23-2300).

**Drive Axle:** Manufacturer — Dana Corp., Model GT-20. Axle serves as a hydraulic fluid reservoir and mates directly with the transmission. Approximately 5 qt. (4.7 l) capacity.

**Brakes:** Mechanical drum type, 7 in. (17.8 cm) dia. x 1-3/4 in. (45 mm) wide. Individually controlled by two pedals connected by cable and conduit for steering assist. Pedals may be latched together for two wheel braking. Lever provided for parking brake.

## Tires, Wheels, Pressure:

Front Tires — 23 x 8.00 x 12  
Rear Tires — 16 x 6.50 x 8  
All tires 4 ply rating, tubeless type.  
(Pressure — 10-15 psi (69-103 kPa).

**Steering:** 13 in. (33 cm) steering wheel. TRW power steering valve.

**Main Frame:** Frame is welded, formed steel.

**Instrumentation:** Fuel gauge, water temperature gauge, hour meter and warning lights for high temperature shutdown, oil pressure, amperage and glow plug are mounted on the console.

**Controls:** Throttle, PTO switch, parking brake, implement lift, ignition switch and glow plug switch are all hand-operated. Forward/reverse traction pedal and turning brakes are foot operated.

**PTO Drive:** Splined PTO shaft is clutched by a torque-teamed HA Section, spring tensioned V-belt directly from engine output shaft. PTO shaft engaged by electric clutch/brake assembly. PTO speed — 2200 RPM @ 3250 RPM engine speed.

**Implement connection** — Universal joint and telescoping shaft assembly.

**Lift Cylinders:** Two, with 2 in. (51 mm) bore, 3.5 in. (89 mm) stroke.

**Interlock Switches:** Prevents engine starting if traction pedal or PTO switch are engaged. Stops engine if operator leaves seat with either traction pedal or PTO switch engaged.

## Dimensions and Weight (approx):

Traction Unit	Length:	82 in. (2.08 m)
w/Standard	Width:	44 in. (1.11 m)
Seat	Height:	50 in. (1.27 m)
	Weight:	1120 lb (508 kg)

## OPTIONAL EQUIPMENT:

**52" Side Discharge Cutting Unit**—Model No. 30555

**52" Rear Discharge Cutting Unit**—Model No. 30568

**62" Side Discharge Cutting Unit**—Model No. 30564

**72" Side Discharge Cutting Unit**—Model No. 30575

**48" V-Plow Kit** — Model No. 30750

**V-Plow Mounting Kit** — Model No. 30749. Required with 30750 V-Plow. 11-0390 Tire Chains recommended.

**Arm Rest Kit** — Model 30707. Fits Models 30769, 30772 Seat Kits.

**Rear Discharge Shield Kit** — Model No. 30567.

**Rear Weight Box Kit** — Part No. 24-5780.

**Grass Collection System** — Model No. 30502, 52" Blower Kit (for Model 30555 deck) or Model 30503 62" Blower Kit (for Model 30564 deck) can be used with either Model No. 30504, 9 cu. ft. Hopper Kit or Model No. 30505, 15 cu. ft. Hopper Kit.

**Wide Tires w/rim; 23 x 10.5 — 12** — Part No. 62-7020.

**Wheel Weights** — Model No. 11-0440. 50 lb (23 kg).

**Rear Weight Kit** — Part No. 24-5780. 70 lb (31.8 kg).

# SPECIFICATIONS

**Tire Chains** — Part No. 11-0390.

**Standard Seat Kit** — Model No. 30769.

**Deluxe Seat Kit** — Model No. 30772.

Refer to Specifications section of individual Cutting Unit Operator's Manuals for the following options:

Leaf Mulcher Kits, Mulcher Plate Kits, Weight Transfer Kits, Front Baffle Kits, Phenolic Wheel Assembly Kits, etc.

## LOOSE PARTS

**Note:** Use this chart as a checklist to make sure all parts have been received. Without these parts, total set-up cannot be completed.

DESCRIPTION	QTY.	USE
Steering wheel	1	Install Steering Wheel.
Foam Seal	1	
Nut	1	
Screw	1	
Cap	1	
Manual Tube	1	Install on right underside of seat.
R-Clamp	2	
Roll Pin	1	Secure universal shaft to implement.
Capscrew 5/16 - 18 x 1-3/4 in.	2	
Locknut 5/16 - 18	2	

## SET-UP INSTRUCTIONS



### WARNING

PTO universal shaft is attached to traction unit frame. **DO NOT ENGAGE PTO** without first removing universal shaft or coupling it to a suitable implement.

### INSTALL STEERING WHEEL

1. Remove jam nut from steering shaft. Slide foam seal and steering wheel onto steering shaft.

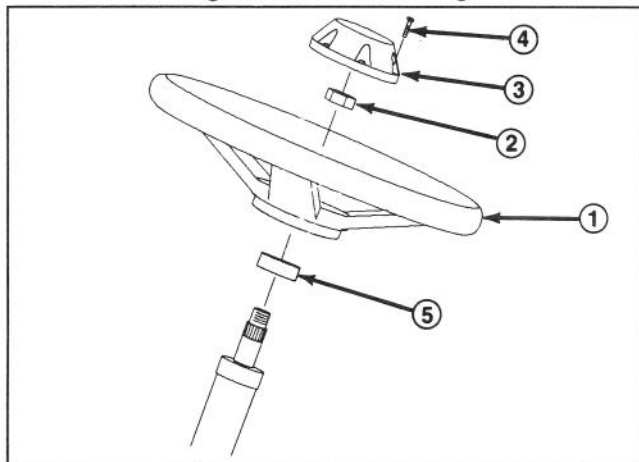

Figure 1

- |                   |              |
|-------------------|--------------|
| 1. Steering wheel | 4. Screw     |
| 2. Jam nut        | 5. Foam seal |
| 3. Cap            |              |

2. Secure steering wheel to shaft with jam nut and tighten it to 10-15 ft-lb.

3. Install cap to steering wheel with screw.

### INSTALLING SEAT

The Groundsmaster 223-D is shipped without the seat assembly. Either optional Seat Kit, Model No. 30769 or 30772 must be installed.

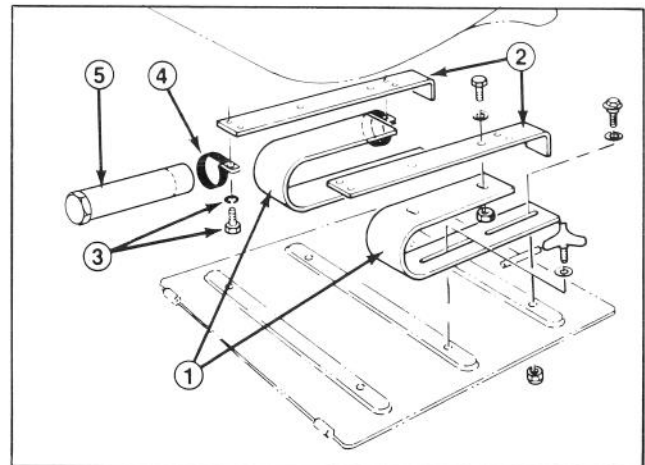

Figure 2

- |                          |                |
|--------------------------|----------------|
| 1. "U" spring            | 4. R-clamp (2) |
| 2. Seat mounting bracket | 5. Manual tube |
| 3. Capscrew and locknuts |                |



# SET-UP INSTRUCTIONS

## Seat Kit, Model No. 30769, Standard Seat:

1. Attach "U" springs to seat mounting brackets using bolts and locknut as shown in (Fig. 2).

2. Install lockwashers and R-Clamps onto each mounting capscrew for the right seat mount. Insert the assemblies through the seat bracket holes and secure the bracket to the seat (Fig. 2). Install lockwashers onto each mounting capscrew for the left seat bracket and secure the bracket to the seat. Install manual tube into R-Clamps, insert manual into tube and place cap over tube end (Fig. 2).

**Note:** Mount the bracket in the forward set of tapped mounting holes in seat.

3. Mount seat and spring assembly to rear holes in traction unit mount plate with two shoulder bolts, flat washers and locknuts (Fig. 3).

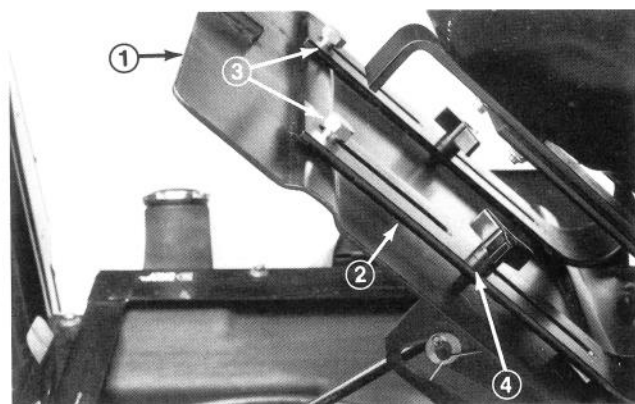

Figure 3

- |                   |  |
|-------------------|--|
| 1. Mounting plate | 3. Shoulder bolt with washer and locknut (2) |
| 2. Seat spring    | 4. Adjustment handle (2)                     |

**Note:** Be sure to use flat washers with small I.D.

**Note:** Traction unit mounting plate can be flipped up by removing the hair pin and pulling back on the locking spring flap (Fig. 4).

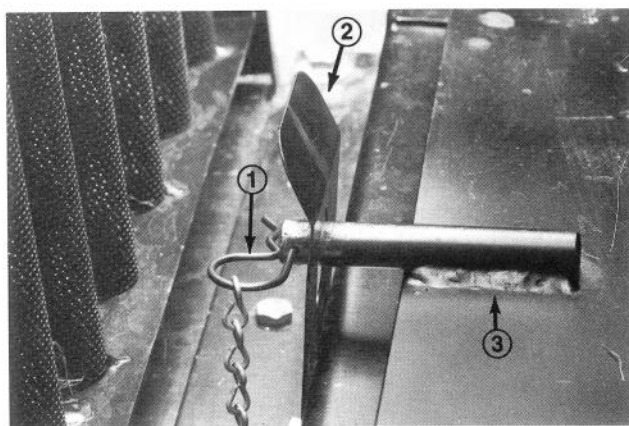

Figure 4

- |                        |
|------------------------|
| 1. Hair pin            |
| 2. Lock spring flap    |
| 3. Seat mounting plate |

**Note:** To secure traction unit mounting plate in an upright position the support rod must be snapped into the indent (Fig. 5).

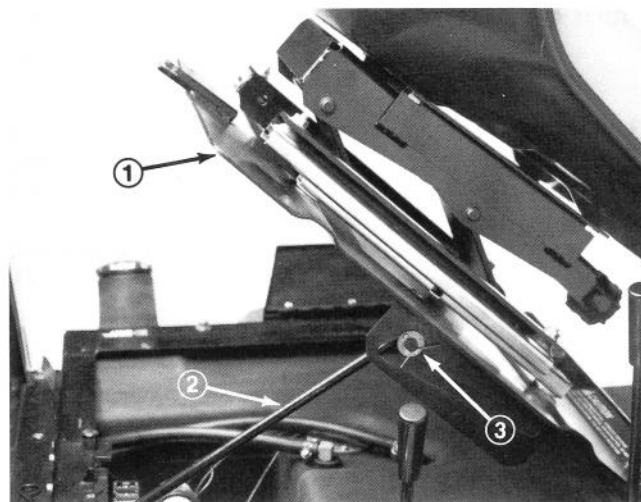

Figure 5

- |                   |           |
|-------------------|-----------|
| 1. Mounting plate | 3. Indent |
| 2. Support rod    |           |

4. Secure front slots of seat springs to traction unit front mounting holes with adjustment handles and flatwashers (Fig. 3).

5. Adjust seat to desired operating position. Loosen adjustment handles, slide seat fore or aft in slotted holes and tighten adjustment handles to secure in place.

## Seat Kit, Model No. 30772, Deluxe Seat:

1. Mount seat mounting plate over four threaded studs at the bottom of seat suspension assembly and secure in place with lockwashers and nuts (Fig. 6 & 7).

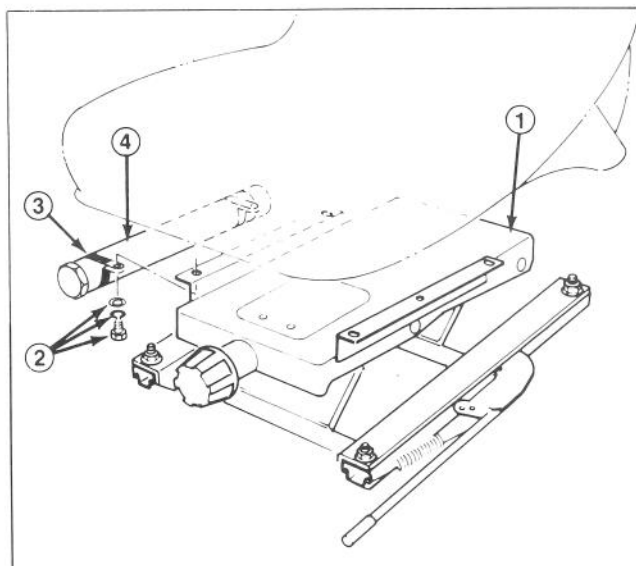

Figure 6

- |  |                |
|--|----------------|
| 1. Adjustable suspension unit          | 3. R-clamp (2) |
| 2. Capscrew, lockwasher and flatwasher | 4. Manual tube |

# SET-UP INSTRUCTIONS

2. Loosely mount bottom of seat and manual tube R-clamps to seat suspension with (4) capscrews, lockwashers and flatwashers. R-clamps to be positioned at right side of seat. Install manual tube into R-clamps and tighten all capscrews.

3. Adjust seat for operator's comfort and weight. To adjust seat fore and aft, pull handle on left side of seat assembly outward (Fig. 7). Release handle to lock seat position. To adjust for operator's weight, turn spring tension knob; clockwise to increase tension, counterclockwise to decrease spring tension (Fig. 7).

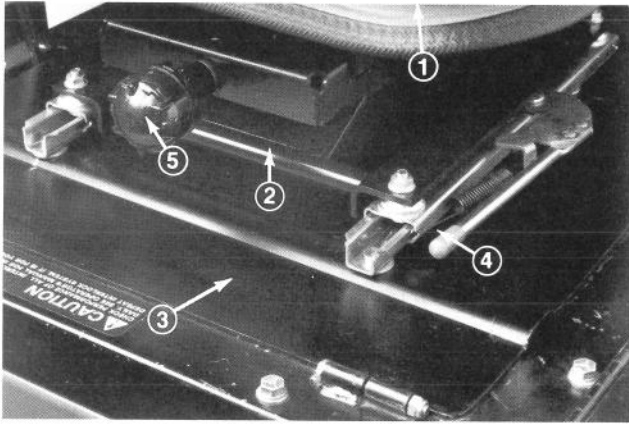

Figure 7

- |                        |                            |
|------------------------|----------------------------|
| 1. Seat                | 4. Forward/backward handle |
| 2. Suspension assembly | 5. Spring tension knob     |
| 3. Mounting plate      |                            |

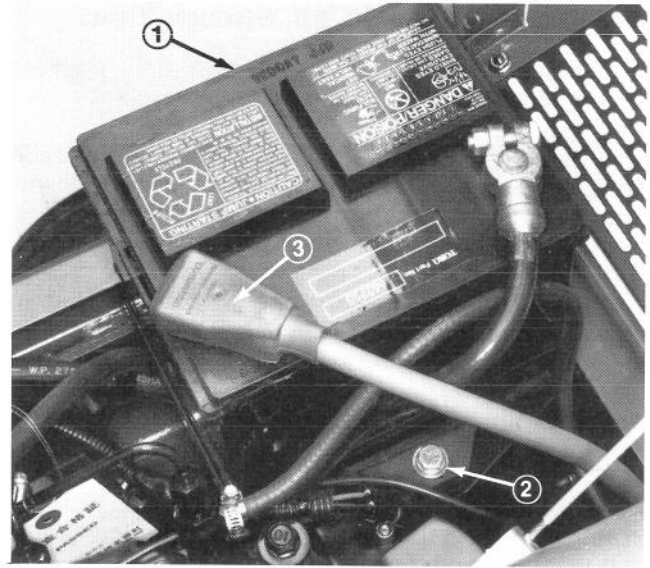

Figure 8

1. Battery
2. Battery securing bolt (2)
3. Rubber boot

**Note:** Make sure battery cables are routed away from any sharp edges or moving parts.

4. Coat the terminal with sealant such as Grafo 112X, Toro Part No. 505-47 and install the rubber boot onto positive terminal.

## CHECK TIRE PRESSURE

The tires are over-inflated for shipping. Therefore, release some of the air to reduce the pressure. Correct air pressure in front and rear tires is 10 to 15 psi.



Figure 9

1. Front tire valve stem

## CONNECT BATTERY

1. Lift engine cover. Check to see that the battery is securely fastened in place (Fig. 8).

2. Check battery charge with a hydrometer. If battery needs charging, be sure at least one of the battery cables is disconnected from the battery before the charger is connected.

3. Remove tape from battery cables and secure the cables to the proper battery post. The positive (+) red cable goes to the positive post and the negative (-) black cable goes to the negative post on the battery.



### WARNING

Connecting cables to the wrong post could damage the electrical system and result in personal injury.

# BEFORE OPERATING

## CHECK CRANKCASE OIL

The engine is shipped with 3.8 qt (3.6 l) of oil in the crankcase; however, level of oil must be checked before and after the engine is first started.

1. Position machine on a level surface.
2. Open the hood.
3. Remove dipstick and wipe it with a clean rag. Insert dipstick into the tube and make sure it is seated fully. Remove dipstick and check level of oil (Fig. 10). If oil level is low, add enough oil to raise level to FULL mark on dipstick. Do not overfill (Fig. 11).

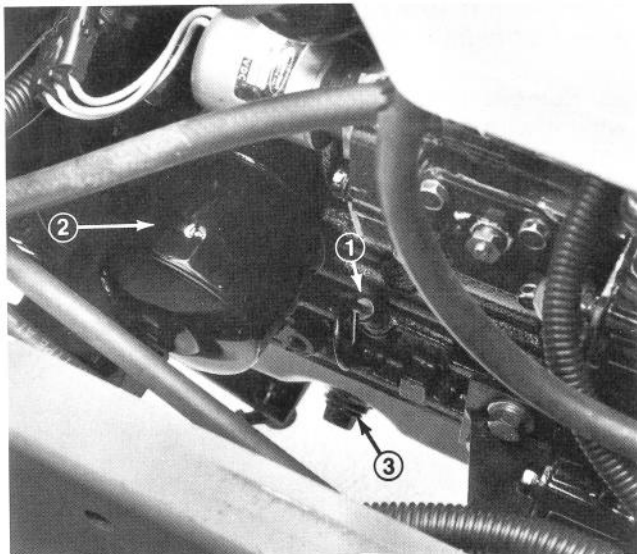

Figure 10

1. Engine oil dipstick
2. Engine oil filter
3. Oil drain plug

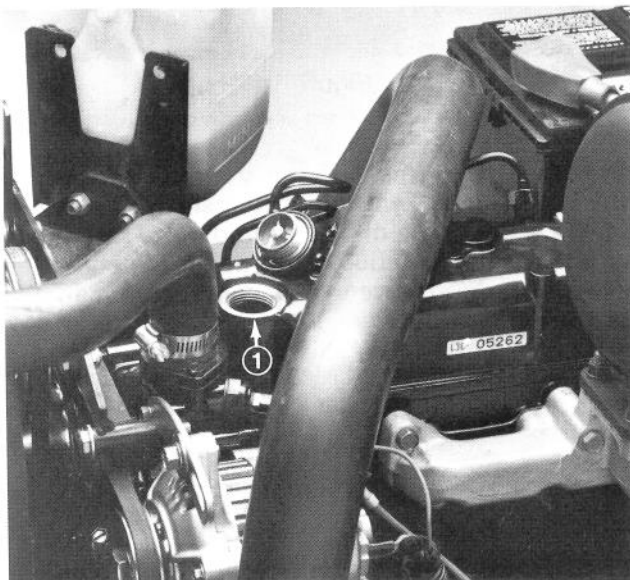

Figure 11

1. Engine oil fill

**Note:** If level of oil is at the ADD mark on the dipstick, add 1 pint (0.47 l) of oil and recheck level. Do not overfill.

4. The engine uses any high-quality 10W30 detergent oil having the American Petroleum Institute — API — “service classification” CD.

**IMPORTANT:** Check level of oil every 5 operating hours or daily. Change oil after every 50 hours of operation.

5. Insert dipstick into tube.

## CHECK COOLING SYSTEM

Clean debris off screen and front of radiator daily (Fig. 12), hourly if conditions are extremely dusty and dirty; refer to Cleaning Radiator and Screen Section.

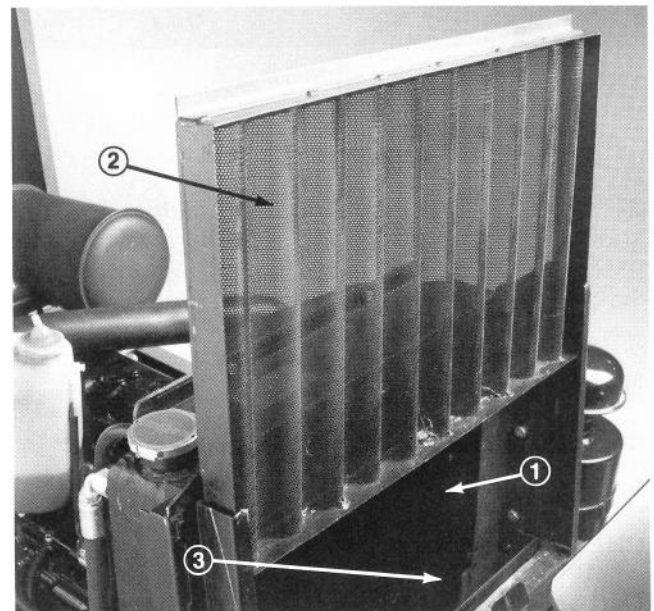

Figure 12

1. Radiator
2. Radiator screen
3. Screen channel

The cooling system is filled with a 50/50 solution of water and permanent ethylene glycol anti-freeze. Check level of coolant at beginning of each day (Fig. 13) before starting the engine. Capacity of cooling system is approximately 6 quarts (5.7 l).

1. Carefully remove radiator cap and the expansion tank cap.



### CAUTION

If engine has been running, pressurized hot coolant can escape when radiator cap is removed and cause burns.

# BEFORE OPERATING

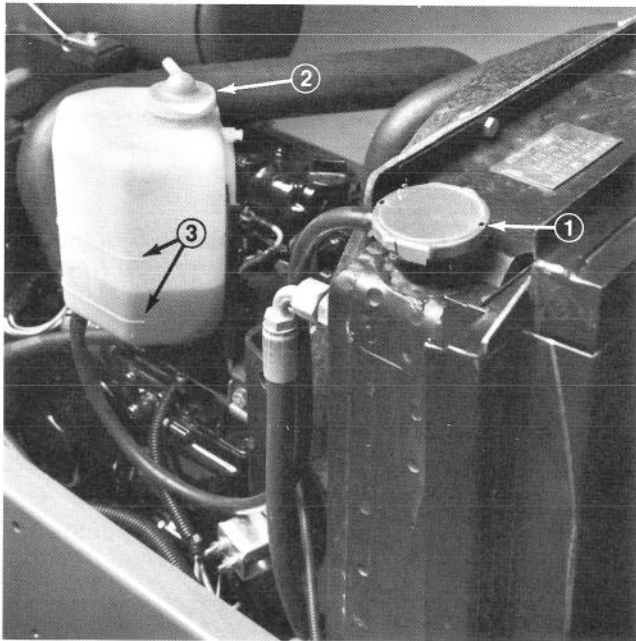

Figure 13

1. Radiator cap
2. Expansion tank cap
3. Expansion tank fill marks

2. Check level of coolant in radiator. Radiator should be filled to the top of the filler neck and the expansion tank filled to between the marks on its side.

3. If coolant level is low, replenish the system. **DO NOT OVERFILL.**

4. Install radiator cap and expansion tank cap.

## CHECK HYDRAULIC SYSTEM FLUID

The hydraulic system was designed to operate on any high quality detergent oil having the American Petroleum Institute — API — “service classification” SF, CC or CD. Oil viscosity — weight — must be selected according to anticipated ambient temperature. Temperature/viscosity recommendations are:

Expected Ambient Temperature	Recommended Viscosity and Type
(Extreme) over 90° F	SAE 30, Type SF, CC or CD engine oil.
(Normal) 40-100° F	SAE 10W-30 or 10W-40. Type SF, CC or CD engine oil.
(Cool — Spring/Fall) 30-50° F	SAE 5W-30, Type SF, CC or CD engine oil.
(Winter) Below 30° F	Type “F” or “FA” ATF Automatic Transmission Fluid.

**Note:** Do not mix engine oil and automatic transmission fluid or hydraulic system component

damage may result. When changing fluids, also change transmission filter. **DO NOT USE DEXRON II ATF.**

The axle housing acts as the reservoir for the system. The transmission and axle housing are shipped from the factory with approximately 5 quarts (4.7 l) of SAE 10W-30 engine oil. However, check level of transmission oil before engine is first started and daily thereafter.

1. Position machine on a level surface. Place all controls in neutral position and start the engine. Run engine at lowest possible RPM to purge the system of air. **Do not engage PTO.** Cycle steering wheel several times fully to the left and right. Raise the cutting unit to extend lift cylinders, aiming steering wheels straight forward and stop the engine.

2. Remove dipstick cap (Fig. 14) from filler neck and wipe it with a clean rag. Screw dipstick cap finger-tight onto filler neck; then remove it and check level of fluid. If level is not within 1/2 inch (13 mm) from the groove in the dipstick (Fig. 14), add SAE 10W-30 engine oil, or, if used, automatic transmission fluid to raise level to groove mark. Do not overfill.

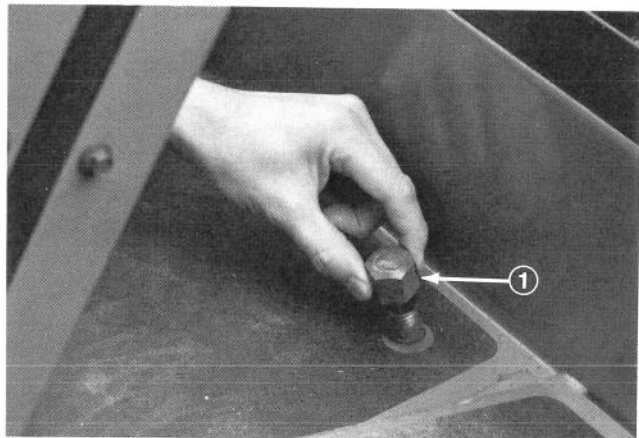

Figure 14

1. Hydraulic system reservoir fluid/add dipstick cap

**IMPORTANT:** When adding transmission fluid to the hydraulic system, use a funnel with a fine wire screen — 200 mesh or finer — and make sure funnel and transmission fluid are immaculately clean. This procedure prevents accidental contamination of the hydraulic system.

3. Thread dipstick filler cap finger-tight onto filler neck. It is not necessary to tighten cap with a wrench.

4. Check all hoses and fittings for leaks.

## FILL FUEL TANK WITH DIESEL FUEL

The engine runs on No. 2-D or 1-D automotive type diesel fuel with a minimum cetane rating of 40.

## BEFORE OPERATING

**Note:** Higher cetane rated fuel may be required if machine is to be used at high altitudes and low-atmospheric temperatures.

Use No. 2-D diesel fuel at temperatures above 20°F (-7°C) and No. 1-D diesel fuel below 20°F (-7°C). Use of No. 1-D diesel fuel at lower temperatures provides lower flash point and pour point characteristics, therefore easing startability and lessening chances of chemical separation of the fuel due to low temperatures (wax appearance, which may plug filters).

Use of No. 2-D diesel fuel above 20°F (-7°C) will contribute toward longer life of the pump components. Do not use furnace oil. Furnace oils usually contain heavy cracked distillates which are not suitable for diesel engines.

Store fuel outside of buildings in a convenient location. Tipping the front of the tank up slightly will allow contaminants to collect at the lower end away from the outlet. Never empty the tank below 4 in. (10 cm) from the bottom of the tank to avoid picking up water and other contaminants that may have collected at the bottom. Either filter the remainder at the bottom through a chamois or dispose of it periodically to prevent excessive build-up of contaminants.

Keep all fuel containers free of dirt, water, scale and other contaminants. Many engine difficulties can be traced to contaminants in the fuel.

Use only metal containers for fuel storage. DO NOT store the fuel in a galvanized metal container. A chemical reaction will result, which will plug the filters and cause possible fuel system damage.

If possible, fill the fuel tank at the end of each day. This will prevent possible buildup of condensation inside the fuel tank, preventing possible engine damage. Allow the engine to thoroughly cool down before refueling.

1. Using a clean rag, clean area around fuel tank cap.

2. Remove cap from the fuel tank (Fig. 15) and fill the 8 gallon (34 l) tank to within 1 inch (25 mm) from the top with diesel fuel. Install fuel tank cap tightly after filling tank.



Figure 15

1. Fuel tank cap



### DANGER

Because diesel fuel is flammable, caution must be used when storing or handling it. Do not fill fuel tank while engine is running, hot or when machine is in an enclosed area. Vapors may build up and be ignited by a spark or flame source many feet away. DO NOT SMOKE while filling the fuel tank to prevent the possibility of an explosion. Always fill fuel tank outside and wipe up any spilled diesel fuel before starting engine. Use a funnel or spout to prevent spilling diesel fuel and fill tank to about 1 inch (25 mm) below the filler neck. Store diesel fuel in a clean safety-approved container and keep the cap in place on the container. Keep diesel fuel in a cool, well-ventilated place; never in an enclosed area such as a hot storage shed. To assure volatility and to prevent contamination, do not buy more than a 6 month supply.

# CONTROLS

**Parking Brake** — Whenever the engine is shut off, the parking brake must be engaged to prevent accidental movement of the machine. To engage the parking brake, push lock arm (Fig. 16) on left brake pedal so that it locks together with the right pedal. Next, push down fully on both pedals and pull parking brake knob out (Fig. 17) then release the pedals. To release parking brake, depress both pedals until parking brake knob retracts. Before starting the engine, however, lock arm may be disengaged from left brake pedal so both pedals work independently with each front wheel.

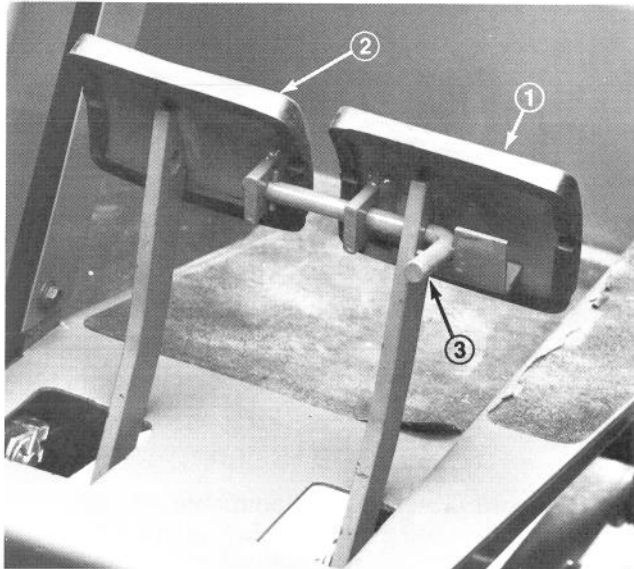

Figure 16

1. Left brake pedal
2. Right brake pedal
3. Lock arm

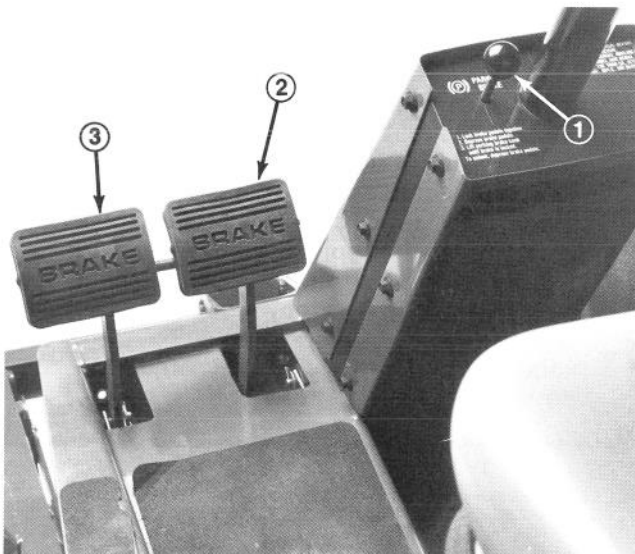

Figure 17

1. Parking brake knob
2. Right brake pedal
3. Left brake pedal

**Amp Light** (Fig. 18) — The amp light should be off when engine is running. If it is on, the charging system should be checked and repaired if necessary.

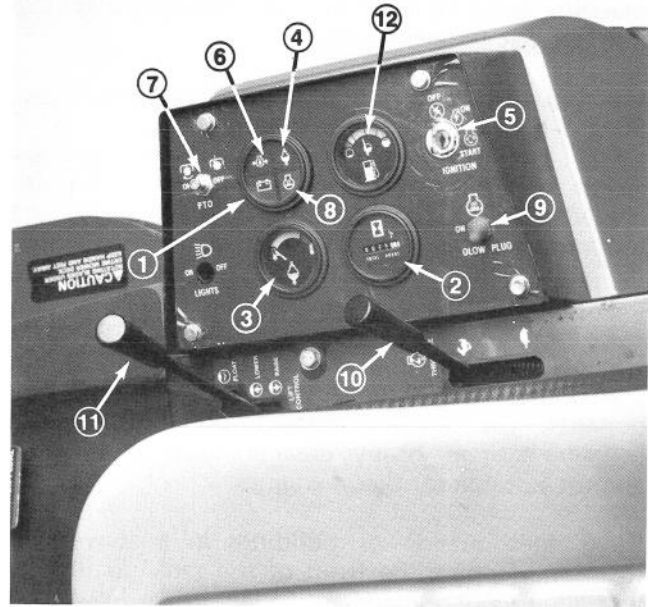

Figure 18

- |                                   |                          |
|-----------------------------------|--------------------------|
| 1. Amp light                      | 7. PTO switch            |
| 2. Hour meter                     | 8. Glow plug indicator   |
| 3. Coolant temperature gauge      | 9. Glow plug switch      |
| 4. High temperature shutoff light | 10. Throttle             |
| 5. Ignition key switch            | 11. Hydraulic lift lever |
| 6. Oil pressure light             | 12. Fuel gauge           |

**Hour Meter** (Fig. 18) — Accumulated engine operating time registers on the hour meter.

**Temperature Gauge and High Temperature Light** (Fig. 18) — The coolant temperature gauge registers the coolant temperature in the system. If the temperature gets too high the engine will automatically shut off and the High Temperature Shutoff Light will light. When this happens, turn the ignition key off, check radiator for debris, check the fan belt and check the expansion tank for proper coolant level. The high temperature shutoff will automatically reset when the coolant temperature has reached a safe level.

**Low Oil Pressure Light** (Fig. 18) — If engine oil pressure falls below a safe level, the light glows. Stop engine and repair before resuming operation.

**PTO Switch** (Fig. 18) — Pull up on sleeve on toggle switch handle and move handle to ON to ENGAGE electric PTO clutch. Pull up on sleeve and move handle to OFF to DISENGAGE electric PTO clutch. The only time the PTO switch should be in the ENGAGE position is when the implement is down in operating position and ready to begin operation.

**Ignition Key Switch** (Fig. 18) — The ignition switch, which is used to start and stop the engine, has three positions: OFF, RUN and START. Rotate key clockwise — START position — to engage starter motor. Release key when engine starts. The key will move automatically to the ON position. To shut engine off, rotate key counterclockwise to the OFF position.

# CONTROLS

**Glow Plug Switch and Indicator** (Fig. 18) — Use to preheat engine cylinders prior to cold engine starting procedures — cylinders are preheated automatically during warm engine start operation. For cold starting, push switch lever upward and hold while watching indicator. Indicator will glow orange when the glow plugs are activated. Length of time necessary to preheat cylinders should be determined by atmospheric temperature; refer to Starting/Stopping Engine procedure.

**Throttle** (Fig. 18) — Throttle is used to operate engine at various speeds. Moving throttle forward increases engine speed — FAST; rearward decreases engine speed — SLOW. The throttle controls the speed of the cutter blades and, in conjunction with traction pedal, controls ground speed of the traction unit.

**Hydraulic Lift Lever** (Fig. 18) — The hydraulic lift lever has three positions: FLOAT, TRANSPORT and RAISE. To lower cutting unit to the ground, move lift lever forward into notch in seat platform — FLOAT. The FLOAT position is used for mowing and when machine is not in operation. To raise cutting unit, pull lift lever rearward to the RAISE position. After cutting unit is raised, allow lift lever to move to the TRANSPORT position. Cutting unit must be raised when driving from one work area to another.

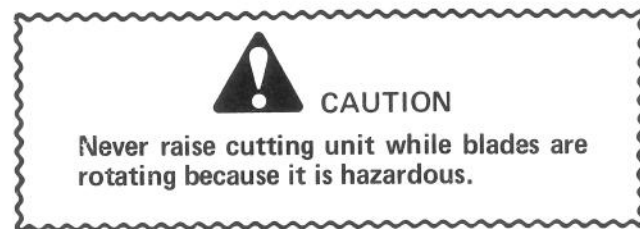

**Service Brakes** (Fig. 17) — The left and right brake pedals are connected to the left and right front wheels. Since both brakes work independently of each other, the brakes can be used to turn sharply or to increase traction if one wheel tends to slip while operating on certain slope conditions. However, wet grass or soft turf could be damaged when brakes are used to turn sharply. To make a “quick-stop”, depress both brake pedals together. Always lock brakes together when transporting the traction unit.

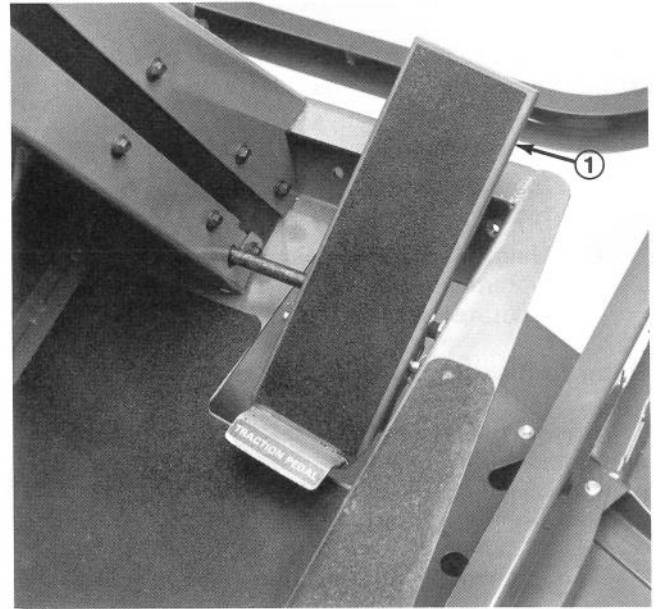

Figure 19

1. Traction pedal

**Traction Pedal** (Fig. 19) — Traction pedal has two functions: one is to make the machine move forward, the other is to make it move rearward. Using the heel and toe of the right foot, depress top of pedal to move forward and bottom of pedal to move rearward. Ground speed is proportionate to how far pedal is depressed. For maximum ground speed, traction pedal must be fully depressed while throttle is in FAST position. Maximum speed forward is 10 mph (16 Km/hr) (approx.), 4 mph (6.4 Km/hr) (approx.) in reverse. To get maximum power under heavy load or when ascending a hill, have throttle in FAST position while depressing traction pedal slightly to keep engine rpm high. When engine rpm begins to decrease, release traction pedal slightly to allow rpm to increase.

**Seat Adjusting Handle** — To adjust seat, loosen adjusting knobs and slide seat to desired position. Tighten knobs to lock seat in place.

**Seat Adjusting Handle — Deluxe Seat** — To adjust seat, move lever on left side outward, slide seat to desired position and release lever so it will lock in track.

# OPERATING INSTRUCTIONS

## STARTING/STOPPING ENGINE

**IMPORTANT:** The fuel system must be bled if any of the following situations have occurred:

- A. Initial start up of a new machine.
- B. Engine has ceased running due to lack of fuel.
- C. Maintenance has been performed upon fuel system components; i.e., filter replaced, separator serviced, etc.

### Refer to Bleeding The Fuel System.

1. Ensure parking brake is set, PTO switch is in OFF position and lift lever is in TRANSPORT or FLOAT position (Fig. 18). Remove foot from traction pedal and insure it is in neutral.
2. **Move throttle control (Fig. 18) to full FAST position.**
3. When temperature is below 15°C (60°F), push glow plug switch to ON position (Fig. 18) and hold for suggested interval.

**Note:** Do not exceed 1 minute of continuous use or glow plug may burn out prematurely.

**Note:** Refer to chart indicating approximate preheat time suggested in various temperature ranges.

Temperature	Preheat time (sec)
Above 5°C (41°F)	10
+5°C (41°F) to -5°C (23°F)	20
Below -5°C (23°F)	30

4. Turn key in ignition switch to START position (Fig. 18). Release key immediately when engine starts and allow it to return to RUN position. Move throttle control to SLOW position.

**Note:** Do not run starter motor more than 20 seconds at a time or premature starter failure may result. If engine fails to start after 20 seconds, turn key to OFF position, recheck controls and procedures, wait 10 additional seconds and repeat starter operation.

5. When engine is started for the first time, or after engine oil change, or overhaul of engine, transmission or axle, operate the machine in forward and reverse for one to two minutes. Also operate the lift lever and PTO lever to assure proper operation of all parts. Turn power steering wheel to the left and right to check steering response. Then shut engine off and check fluid levels, check for oil leaks, loose parts and any other noticeable malfunctions.



### CAUTION

Shut engine off and wait for all moving parts to stop before checking for oil leaks, loose parts or other malfunctions.

6. To stop engine, move throttle control backward to SLOW position, move PTO switch to OFF position and rotate ignition key to OFF. Remove key from switch to prevent accidental starting.

## BLEEDING FUEL SYSTEM

1. Raise hood over engine.
2. Loosen air bleed screw on top of fuel filter/water separator (Fig. 20).

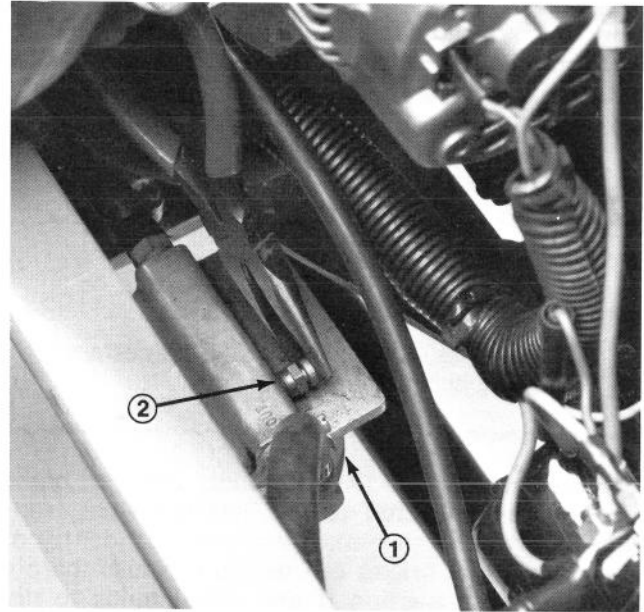

Figure 20

1. Fuel filter
2. Air bleeder screw

3. Turn key in ignition switch to the RUN position. Electric fuel pump will begin operation, thereby forcing air out around air bleed screw. Leave key in RUN position until solid stream of fuel flows out around screw. Tighten screw and turn key to OFF.
4. Open the air bleed screw on the fuel injection pump (Fig. 21) with a 10 mm wrench.
5. Turn key in ignition switch to the RUN position. Electric fuel pump will begin operation, thereby, forcing air out around air bleed screw on fuel injection pump. Leave key in RUN position until solid stream of fuel flows out around the screw. Tighten screw and turn key to OFF.



# OPERATING INSTRUCTIONS

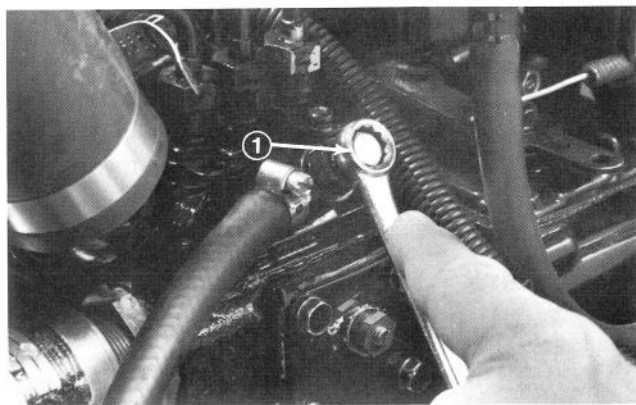

Figure 21

1. Fuel injection pump bleeder

**Note:** Normally, engine should start after above bleeding procedures are followed. However, if engine does not start, air may be trapped between injection pump and injectors; refer to Bleeding Air From Injectors.

## CHECKING OPERATION OF INTERLOCK SWITCHES

The purpose of the safety interlock system is to prevent the engine from cranking or starting unless the traction pedal is in neutral and the PTO switch is in the OFF position. In addition, the engine will stop when the PTO control is engaged or traction pedal is depressed with operator off the seat.



### CAUTION

Do not disconnect the safety switches because they are for the operator's protection. Check operation of the switches daily to be sure the interlock system is operating correctly. If a switch is malfunctioning, replace it before operating the machine. Replace the switches every 2 years to be sure of maximum safety.

1. Move PTO switch to OFF position and remove foot from traction pedal so it is fully released.
2. Rotate the ignition key to START. Engine should crank. If engine cranks, proceed to step 3. If engine does not crank, there may be a malfunction in the interlock system.
3. Raise off the seat and engage the PTO switch while the engine is running. The engine should stop within 2 seconds. If engine stops, the switch is operating correctly; thus, proceed to step 4. If engine does not stop, there is a malfunction in the interlock system.
4. Raise off the seat and depress the traction pedal while engine is running the PTO lever is disengaged. The engine should stop within 2 seconds. If engine

stops, the switch is operating correctly; thus, continue operation. If engine does not stop, there is a malfunction in the interlock system.

## OPERATING CHARACTERISTICS

Practice driving the GROUNDMASTER® 223D before initial operation because it has a hydrostatic transmission and its characteristics are different than some turf maintenance machines. Some points to consider when operating the traction unit and cutting unit are the transmission, engine speed, load on the cutting blades, and the importance of the brakes.

To maintain enough power for the traction unit and cutting unit while mowing, regulate traction pedal to keep engine rpm high and somewhat constant. A good rule to follow is: decrease ground speed as the load on the cutting blades increases; and increase ground speed as load on the blades decreases. This allows the engine, working with the transmission, to sense the proper ground speed while maintaining high blade tip speed necessary for good quality-of-cut. Therefore, allow traction pedal to move upward as engine speed decreases, and depress pedal slowly as speed increases. By comparison, when driving from one work area to another — with no load and cutting unit raised — have throttle in FAST position and depress traction pedal slowly but fully to attain maximum ground speed.



### CAUTION

Adequate rear weight is necessary to prevent the rear wheels from leaving the ground. Do not stop suddenly while cutting unit or implement is raised. Do not travel down hill with the cutting unit or implement raised. If the rear wheels leave the ground steering is lost.

**CAUTION:** This product may exceed noise levels of 85 dB(A) at the operator position. Ear protectors are recommended for prolonged exposure to reduce the potential of permanent hearing damage.

Another characteristic to consider is the operation of the brakes. The brakes can be used to assist in turning the machine; however, use them carefully, especially on soft or wet grass because the turf may be torn accidentally. The brakes can be used to great advantage to control the direction of the cutting unit when trimming along fences or similar objects. The other benefit of the brakes is

# OPERATING INSTRUCTIONS

to maintain traction. For example: in some slope conditions, the uphill wheel slips and loses traction. If this situation occurs, depress uphill brake pedal gradually and intermittently until the uphill wheel stops slipping; thus, increasing traction on the downhill wheel. If independent braking is not desired, engage the lever on left brake pedal with right pedal. This provides simultaneous braking at both wheels.

Before stopping the engine, disengage all controls and move throttle to SLOW. Moving throttle to SLOW reduces high engine speed, noise and vibration. Turn ignition key to OFF to stop the engine.

## PUSHING OR TOWING TRACTION UNIT

In an emergency, the traction unit can be pushed or towed for a very short distance. However, Toro does not recommend this as standard procedure.

**IMPORTANT:** Do not push or tow the traction unit faster than 2 to 3 mph (3.2 to 4.8 Km/hr) because transmission may be damaged. If traction unit must be moved a considerable distance, transport it on a truck or trailer. Whenever traction unit is pushed or towed, by-pass valve must be open.

1. Remove hair pin, pivot seat platform forward and locate seat support rod in detent notch.

2. Depress and hold the pins located in the center of the two (2) check valve assemblies in the top of the transmission (Fig. 22) while pushing or towing the machine.

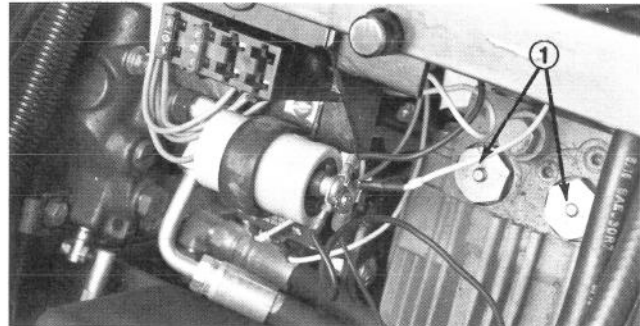

Figure 22

1. Transmission check valve bypass pins (2)

3. Start engine momentarily after repairs are completed and make sure the pins are in the full disengaged (fully up) position.

**IMPORTANT:** Running the machine with by-pass valve open will cause the transmission to overheat.

# LUBRICATION MAINTENANCE

**Note:** Refer to service decal, located in tool box, for general maintenance information.

## GREASING BEARINGS AND BUSHINGS

The traction unit has grease fittings that must be lubricated regularly with No. 2 General Purpose Lithium Base Grease. If machine is operated under normal conditions, lubricate all bearings and bushings after every 25 hours of operation. Bearings and bushings must be lubricated daily when operating conditions are extremely dusty and dirty. Dusty and dirty operating conditions could cause dirt to get into the bearings and bushings, resulting in accelerated wear.

Apply a liberal coating of grease to the check valve pins once each year (Fig. 22). Also grease the bearings in the Dana axle every 500 hours, or yearly, whichever comes first (not shown). The traction unit has bearings and bushings that must be lubricated, and these lubrication points are: PTO universal shaft (Fig. 23); lift arm pivot bushings (Fig. 24); brake pivot bushings (Fig. 25); rear wheel spindle bushings (Fig. 26); steering plate bushings (Fig. 27); axle pin bushing (Fig. 27); PTO tension pivot (Fig. 28). Also apply grease to both brake cables at the drive wheel and brake pedal ends (Fig. 25). Lubricate the traction pedal (Fig. 29).

2. Pump grease into the bearing or bushing.

3. Wipe up excess grease.

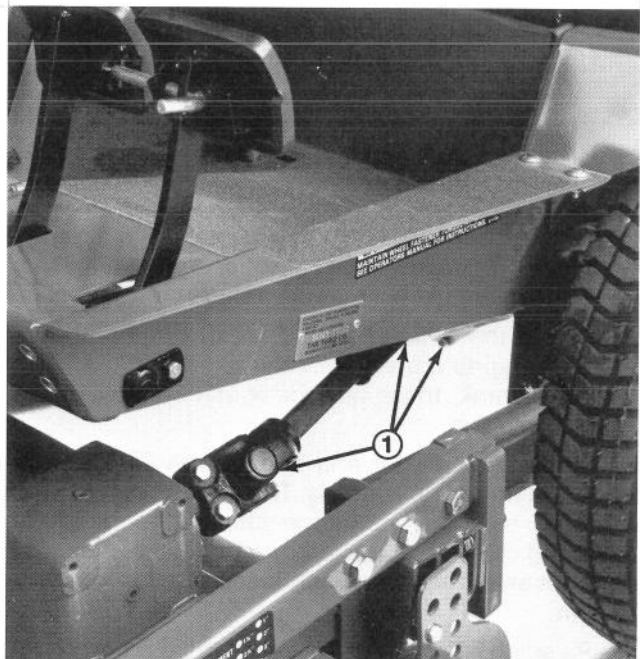

Figure 23

1. PTO shaft lubrication: 3 places on shaft

1. Wipe grease fitting clean so foreign matter cannot be forced into the bearing or bushing.

# LUBRICATION MAINTENANCE

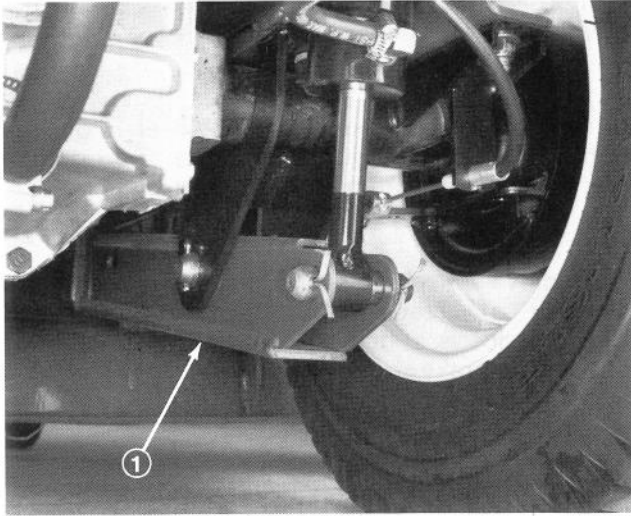

Figure 24

1. Lift arm pivot bushings on each side

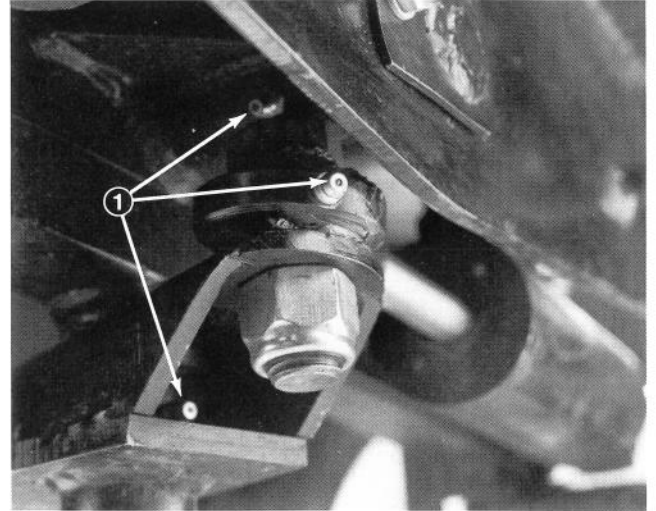

Figure 27

1. 3 fittings: rear axle

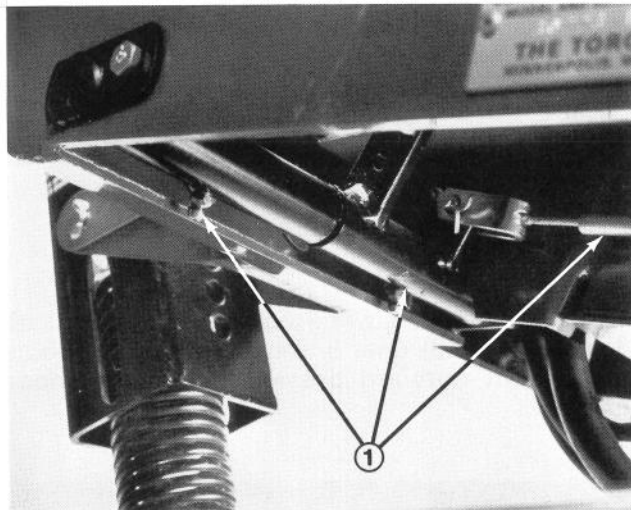

Figure 25

1. Apply grease to both ends of both brake cables and brake pivot tubes.

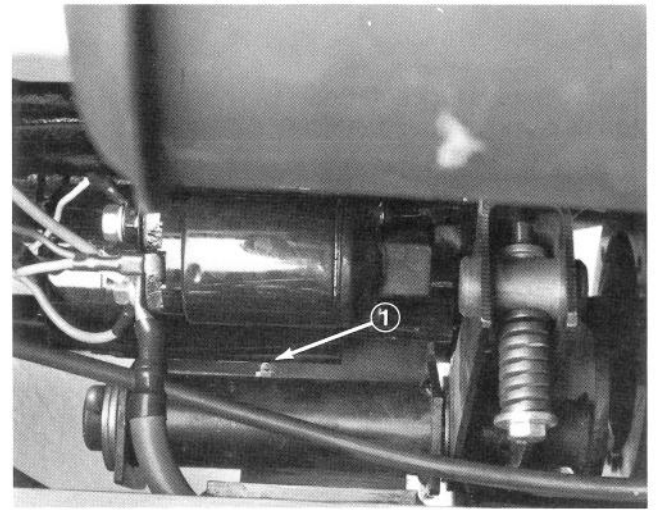

Figure 28

1. Grease PTO tension pivot

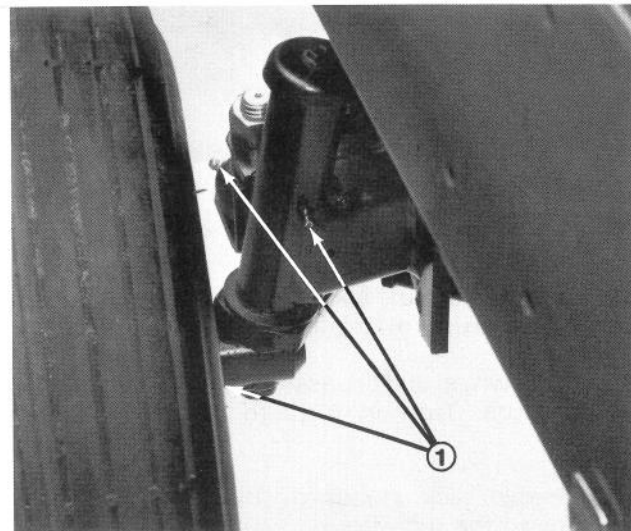

Figure 26

1. Steering arm & wheel lubrication, 2 fittings on one side, 1 on the other side.

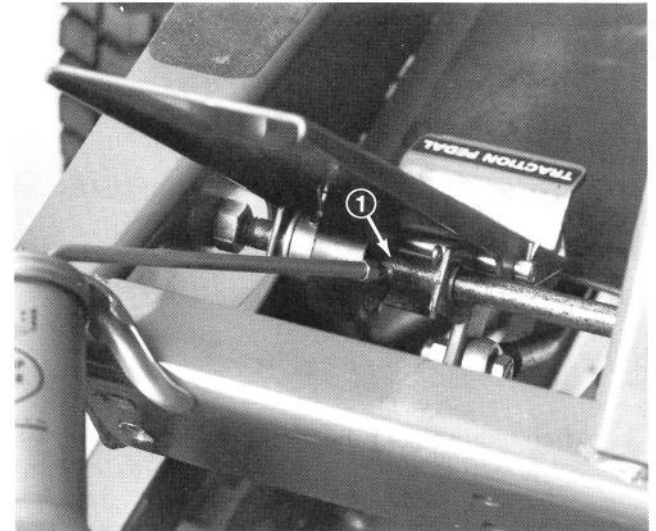

Figure 29

1. Lubricate traction pedal

# BRAKE MAINTENANCE

## ADJUSTING SERVICE BRAKES

Adjust the service brakes when there is more than one inch (25 mm) of "free travel" of the brake pedals, or when the brakes do not work effectively. Free travel is the distance the brake pedal moves before braking resistance is felt.

The brakes should be checked for adjustment after the first 25 hours operation and should only need adjusting after considerable use thereafter. These periodic adjustments can be performed where the brake cables connect to the bottom of the brake pedals. When the cable is no longer adjustable, the star nut on inside of the brake drum must be adjusted to move the brake shoes outward. However, the brake cables must be adjusted again to compensate for this adjustment.

1. Disengage lock arm from right brake pedal so both pedals work independently of each other.

2. To reduce free travel of brake pedals — tighten the brakes — loosen front nut on threaded end of brake cable (Fig. 30). Then tighten rear nut to move cable backward until brake pedals have 1/2 to 1 inch (13 mm to 25 mm) of free travel. Tighten front nut after brakes are adjusted correctly.

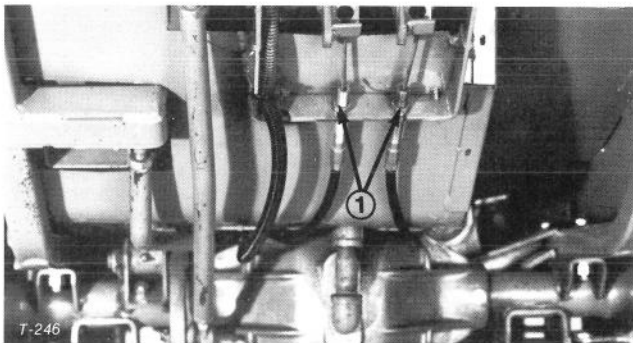

Figure 30  
1. Jam nuts

3. When adjustment of brake cables cannot get free travel within 1/2 to 1 inch (13 mm to 25 mm), the star-nut inside the brake drum must be adjusted. However, before adjusting the star-nut, loosen brake cable nuts to prevent unnecessary strain on the cables.

4. Loosen five wheel nuts holding wheel and tire assembly on wheel studs.

5. Jack up machine until front wheel is off the shop floor. Use jack stands or block the machine to prevent it from falling accidentally.

6. Remove wheel nuts and slide wheel and tire assembly off studs. Rotate brake drum until adjusting slot is at top and centered over star-nut that adjusts brake shoes (Fig. 31).

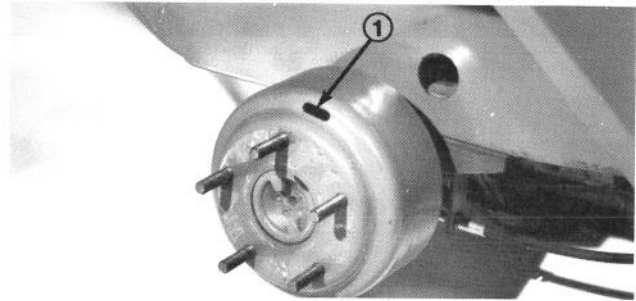

Figure 31

1. Brake adjusting slot

7. Using a brake adjusting tool or screwdriver rotate star-nut (Fig. 32) until brake drum (Fig. 31) locks because of outward pressure of brake shoes (Fig. 32).

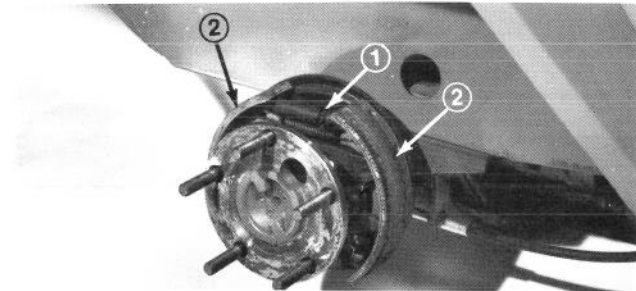

Figure 32

1. Star nut 2. Brake shoe

8. Loosen star-nut about 12 to 15 notches or until brake drum rotates freely.

9. Install wheel and tire assembly on studs with five wheel nuts. Tighten nuts to 45-55 ft-lb (61-74) N·m).

10. Remove jack stands or blocking and lower machine to the shop floor.

11. Adjust the brake cables; use step 2.

# AIR CLEANER MAINTENANCE

## GENERAL MAINTENANCE PRACTICES

To prevent possible severe engine damage and ensure maximum engine service life, periodically inspect the air cleaner and hose assembly.

1. Assure hose between air cleaner and carburetor is clamped securely in place. Replace the hose if it is cracked or punctured.
2. Check air cleaner body for dents and other damage which could possibly cause an air leak. Replace a damaged air cleaner body.
3. Insure dust cap is sealing around bottom of air cleaner body.
4. Mounting screws and nuts holding air cleaner in place must be tight.
5. Inlet cap must be free of obstructions.

## SERVICING DUST CUP AND BAFFLE

Inspect the dust cup and rubber baffle once a week or every 50 hours operation; however, daily or more frequent inspection is required when operating conditions are extremely dusty and dirty. Never allow dust to build up closer than one inch (25 mm) from the rubber baffle.

**Note:** If conditions are extremely dusty and dirty, begin by checking dust cup and baffle after each day's operation to establish approximately how long an interval passes before dust cup should be emptied. Base further maintenance requirements on this figure. These conditions may be particularly prevalent if the rear discharge cutting unit is attached.

1. Loosen thumb screw until dust cap and baffle can be removed (Fig. 33). Separate dust cap and baffle (Fig. 33).
2. Dump dust out of the dust cup. After cleaning cup and baffle, assemble and reinstall both parts.

## SERVICING AIR CLEANER FILTER

Service the air cleaner filter every 250 hours or more frequently in extreme dusty or dirty conditions by washing or using compressed air. Replace the element after every six cleanings (1500 hours) or annually, whichever comes first.

1. Remove and service dust cup; refer to Servicing Dust Cup and Baffle.
2. Remove wing nut w/gasket and slide filter element out of air cleaner body (Fig. 33).

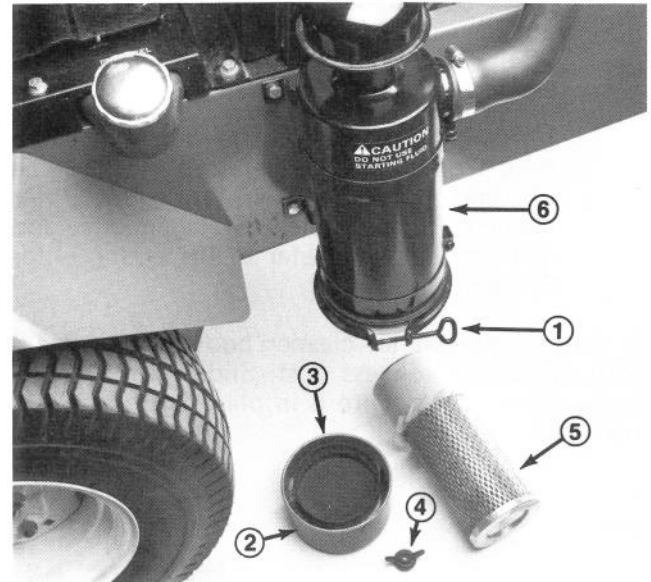

Figure 33

- |                |                         |
|----------------|-------------------------|
| 1. Thumb screw | 4. Wing nut with gasket |
| 2. Dust cap    | 5. Filter element       |
| 3. Baffle      | 6. Air cleaner body     |

3. Clean the element by washing it in a solution of filter cleaner (Part No. 27-7220, available from Toro) and water, or blow dirt out of filter by using compressed air.

**Note:** Compressed air is recommended when element must be used immediately after servicing because a washed element must be dried before it is used. By comparison, washing the element cleans better than blowing dirt out with compressed air. Remember though, filter must be washed when exhaust soot is lodged in the filter pores.

### Washing Method

**IMPORTANT:** Do not remove plastic fin assembly because washing removes dust from beneath fins.

- A. Prepare a solution of filter cleaner and water and soak filter element about 15 minutes. Refer to directions on filter cleaner carton for complete information.
- B. After soaking filter for 15 minutes, rinse it with clear water. Maximum water pressure must not exceed 40 psi (276 kPa) to prevent damage to the filter element.
- C. Dry filter element using warm, flowing air (160° F (71° C) max). or allow element to air-dry. Do not use compressed air or a light bulb to dry the filter element because damage could result.

### Compressed Air Method

**IMPORTANT:** Do not remove plastic fin assembly because back-blowing with compressed air removes dust from beneath fins.

# AIR CLEANER MAINTENANCE

- A. Blow compressed air from inside to the outside of dry filter element. Do not exceed 100 psi (689 kPa) to prevent damage to the element.
  - B. Keep air hose nozzle at least one inch (25 mm) from pleated paper, and move nozzle up and down while rotating the filter element. Inspect element when dust and dirt are removed; refer to Inspecting Filter Element.
4. Wipe inside of air cleaner body with a damp cloth to remove excess dust. Slide filter into air cleaner body and secure it in place with wing nut and gasket.

5. Reinstall dust cup and baffle. Move thumb screw behind air cleaner body and tighten it securely.

## INSPECTING FILTER ELEMENT

1. Place bright light inside filter.
2. Rotate filter slowly while checking for cleanliness, ruptures, holes and tears. Replace defective filter element.
3. Check fin assembly, gasket and screen for damage. Replace filter if damage is evident.

# ENGINE MAINTENANCE

## CLEANING RADIATOR AND SCREEN

To prevent the engine from overheating, the screen and front of the radiator must be kept clean. Normally, check the screen and front of radiator daily and, if necessary, clean any debris off these parts. However, it will be necessary to check and clean the screen and radiator frequently in extremely dusty and dirty conditions.

**Note:** If engine shuts off due to overheating, first check the radiator and screen for excessive buildup of debris.

To thoroughly clean the radiator:

1. Remove the screen.
2. Working from the fan side of the radiator, either spray the radiator with a water hose or blow with compressed air.
3. After the radiator is thoroughly cleaned, clean out debris that may have collected in the channel at the radiator base.
4. Clean and install the screen.

## CHANGING CRANKCASE OIL AND FILTER

Check oil level after each days operation or each time machine is used. Change oil after every 50 hours of operation; change oil filter after first 50 hours and every 100 hours operation thereafter. If possible, run engine just before changing oil because warm oil flows better and carries more contaminants than cold oil.

1. Position machine on a level surface.
2. Open the hood. Set drain pan under the oil pan and in line with drain plug (Fig. 34).
3. Clean area around drain plug.

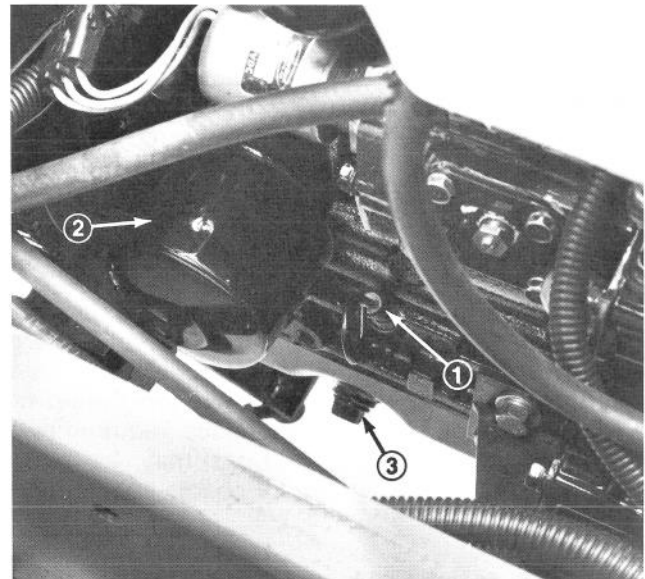

Figure 34

1. Engine oil dipstick
2. Engine oil filter
3. Oil drain plug

4. Remove oil drain plug and allow oil to flow into drain pan. Remove and replace oil filter (Fig. 34); refer to parts catalog for part number.

5. After oil is drained, reinstall drain plug and wipe up any oil that is spilled.

6. Fill crankcase with oil; refer to Check Crankcase Oil.

## SERVICING FUEL SYSTEM

**Note:** Refer to Fill Fuel Tank With Diesel Fuel for proper fuel recommendations.

# ENGINE MAINTENANCE

## Fuel Tank

Drain and clean fuel tank every 400 hours operation or yearly, whichever comes first. Also, drain and clean tank if fuel system becomes contaminated or if machine is to be stored for an extended period. Use clean diesel fuel to flush out the tank.

## Fuel Lines and Connections

Check lines and connections every 400 hours or yearly, whichever comes first. Inspect for deterioration, damage or loose connections.

## Fuel Filter/Water Separator

Drain water or other contaminants from fuel filter/water separator daily (Fig. 35) by loosening drain plug on filter canister. Tighten plug after draining. Replace filter canister after every 400 hours of operation; refer to Specifications for Toro part number.

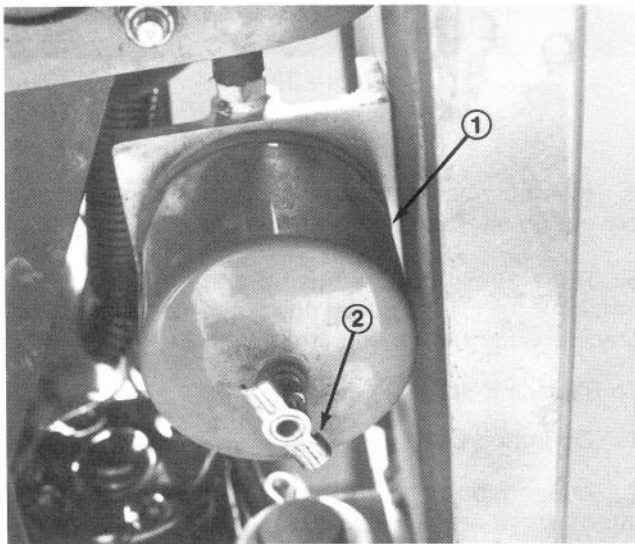

Figure 35

1. Fuel filter canister
2. Water drain

1. Clean area where filter canister mounts.
2. Remove filter canister and clean mounting surface.
3. Lubricate gasket on filter canister with 10W-40 SF-CC oil.
4. Install filter canister by hand until gasket contacts mounting surface, then rotate an additional 1/2 turn.

## Fuel Pump Filter

Remove and replace the filter after every 400 hours operation.

1. Fuel pump is located on inner frame on alternator side of engine (Fig. 36).

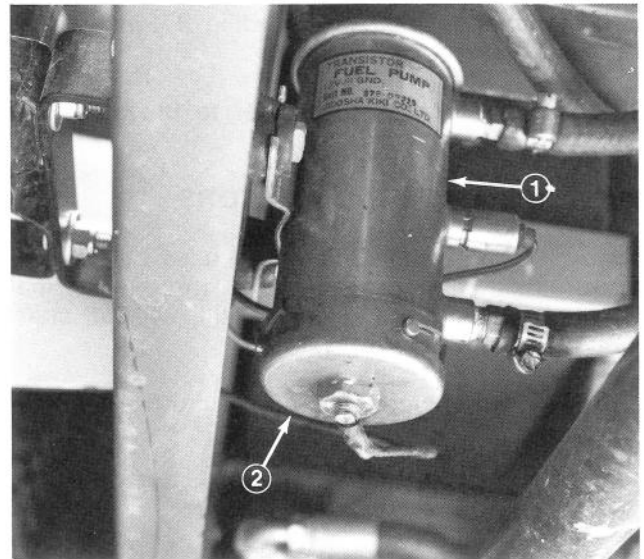

Figure 36

1. Fuel pump assembly
2. Fuel pump cover — unscrew

2. Thoroughly clean outside of assembly.
3. Place a drain pan under fuel pump and remove cover from fuel pump with 17 mm wrench (Fig. 37). Take care not to damage wire while removing cover.
4. Pull filter out of pump body (Fig. 37).

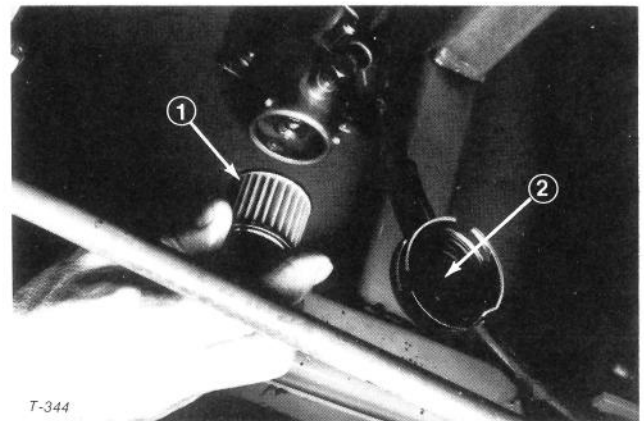

Figure 37

1. Filter
2. Magnet

5. If filter is to be cleaned, wash thoroughly in cleaning solvent and blow compressed air from inside toward outside of element. Hold air nozzle at least one inch (25 mm) from filter and move up and down while rotating filter. Do not exceed 100 psi (689 kPa) to avoid filter damage.

**Note:** Replace the filter if there is any visible dirt which cannot be washed out.

6. Inspect the two rubber gaskets; replace them if damaged.

# ENGINE MAINTENANCE

7. Clean magnet of any residue (Fig. 37), insert filter into body and install cover.

8. Bleed the fuel system; refer to Bleeding Fuel System.

## BLEEDING AIR FROM INJECTORS

**Note:** This procedure should be used only if fuel system has been purged of air through normal priming procedures and engine still will not start; refer to Bleeding Fuel System.

1. Loosen the pipe connection to the No. 1 nozzle and holder assembly (Fig. 38).

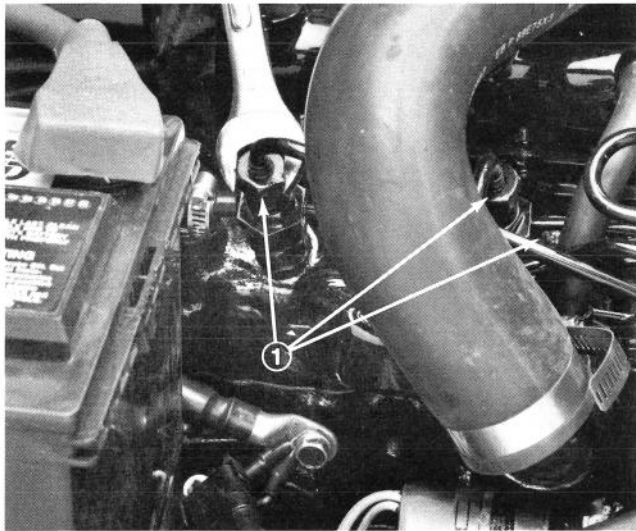

Figure 38

1. Fuel injectors (3)

2. Move throttle control to full FAST position.

3. Turn key in key switch to START position and watch fuel flow around connector. Turn key to OFF position when solid flow is observed.

4. Tighten pipe connector securely.

5. Repeat steps 1-4 on No. 2 and 3 nozzles.

## SERVICING ENGINE BELTS

Check tension of all belts initially after the first day of operation and every 100 hours thereafter.

### Alternator Belt

To Check Tension:

1. Open hood.

2. Check tension by depressing belt midway between alternator and crankshaft pulleys with 22 lb (10Kg) of force. Belt should deflect 7/16 in. (9 to 11 mm). If deflection is incorrect, proceed to step 3. If correct, continue operation.

3. Loosen bolt securing brace to engine and bolt securing alternator to brace (Fig. 39).

**Note:** Metric wrenches will be required.

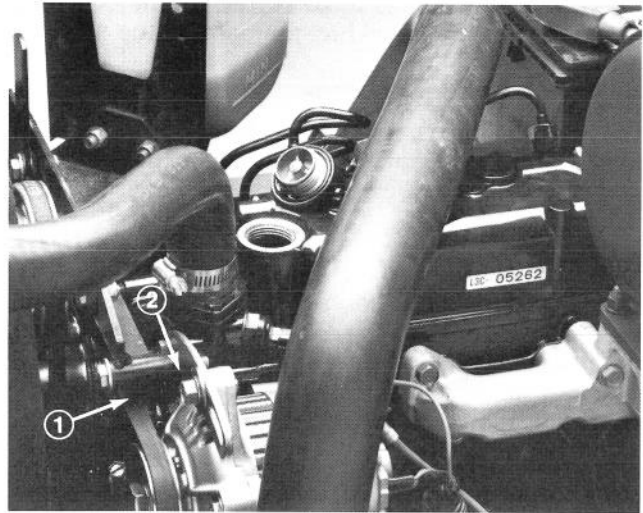

Figure 39

1. Alternator/water pump belt  
2. Tension adjustment bolt

4. Insert pry bar between alternator and engine and pry out on alternator.

5. Hold alternator in position after proper belt tension setting is achieved and tighten alternator and brace bolts to secure adjustment.

To Replace Belt:

1. Open hood.

2. Loosen bolts securing brace to engine and alternator to brace (Fig. 39).

3. Remove two capscrews holding the transmission drive shaft coupler to the engine pulley (Fig. 40). Do not remove the drive shaft from the transmission.

4. Move the drive shaft out of the way so that the fan belt can be removed and a new belt installed. Install the new belt around the fan before positioning it around the drive pulley.

5. Reinstall the drive shaft. Tension the new belt. Close the hood.

6. Check the belt tension after one day's use.

### Cooling Fan Belt

To Check and Adjust Tension:

1. Open hood.

2. Loosen idler pulley bolts (Fig. 40). Put 10 lb. of force on the top of idler pulley bracket and tighten the bolts.

3. Close hood.



# ENGINE MAINTENANCE

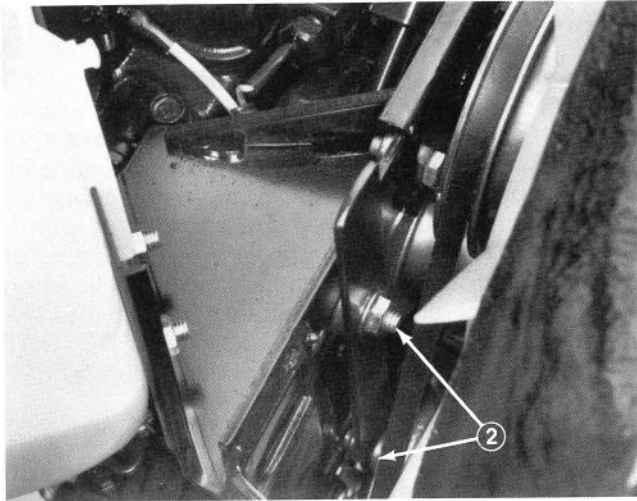

Figure 40

1. Fan belt
2. Belt tensioning bolts (2)

To replace belt:

1. Open hood. Loosen two flange nuts securing idler pulley bracket and move pulley away from belt (Fig. 40).
2. Disconnect the transmission drive shaft assembly from the engine or crankshaft pulley.
3. Remove the belt from the top and bottom pulleys.
4. Install new belt and reconnect the transmission drive shaft assembly to the engine crankshaft pulley.
5. Adjust belt tension; refer to: To Check and Adjust Tension.
6. Close the hood.

**Note:** Check fan belt tension after first day of operation. Readjust tension, if necessary. Follow regular maintenance check procedures thereafter.

## PTO BELT

To Check Tension:

1. Turn engine off and remove the ignition key. Set the parking brake. Raise the engine hood and allow the engine to cool.
2. Loosen the tensioning rod jam nut (Fig. 41).
3. Use a 1/2" wrench to tighten or loosen the belt tensioning spring (Fig. 41). Adjust spring to a length of 1-1/2" (38 mm).
4. Tighten jam nut.

To Replace Belt:

1. Turn off the engine and remove the ignition key. Set the parking brake. Raise the hood and allow the engine to cool.
2. Loosen the tensioning rod jam nut (Fig. 41).
3. Using a 1/2" wrench, loosen the belt tensioning spring (Fig. 41) all the way.

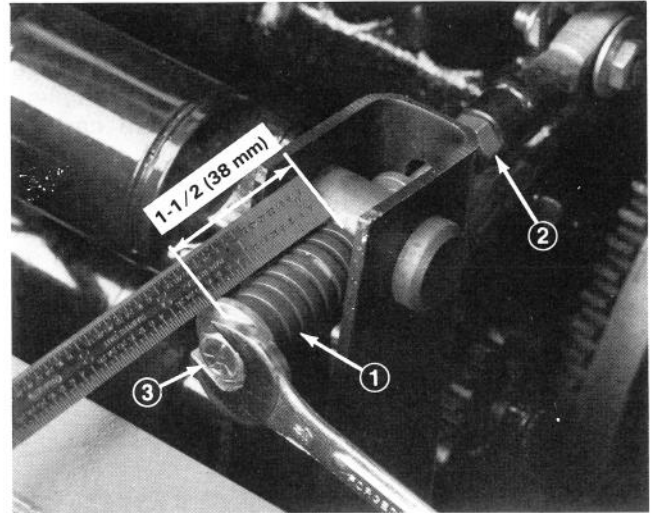

Figure 41

1. Tensioning spring
2. Tensioning rod jam nut
3. Tension adjusting bolt

4. Rotate PTO pulley toward the engine and remove the belt (Fig. 42).
5. Install the new PTO belt and retension the pulley spring to 1-1/2" (38 mm) (Fig. 41).
6. Tighten the jam nut (Fig. 41) and close the hood.

## PTO CLUTCH ADJUSTMENT

The power take off electric clutch can be adjusted by following the following procedure:

1. Turn engine off and remove the ignition key. Set the parking brake. Raise the engine hood and allow the engine to cool.
2. Remove the left hand clutch retainer bracket nut and bolt so that the retainer bracket rubber bumper can be removed (Fig. 42).

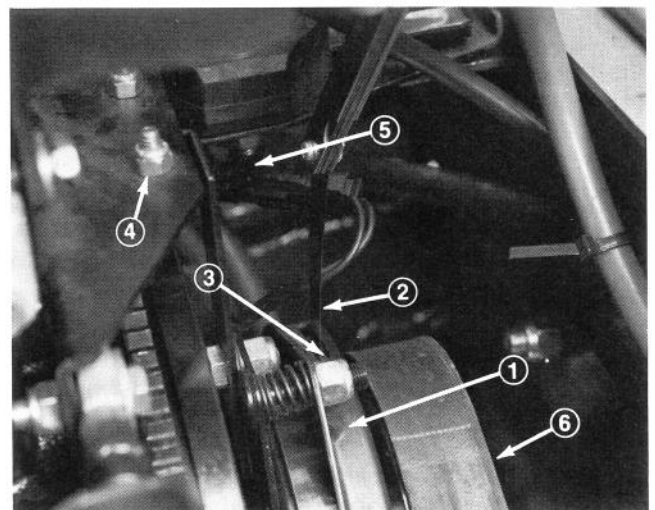

Figure 42

1. Clutch
2. .015" air gap (3)
3. Adjusting nut (3)
4. Left retainer bracket nut & bolt
5. Electrical connector
6. PTO belt

# ENGINE MAINTENANCE

3. Unplug clutch electric connector (Fig. 42).
4. Adjust the air gap so that a .015 inch feeler gauge slides in between the clutch lining and friction plate with light pressure (Fig. 42). The gap can be decreased by turning the adjusting nut clockwise (Fig. 41).
5. Rotate the clutch by hand and adjust all three air gaps. After all three gaps have been set, check all three again. Adjusting one gap can alter the other gaps.
6. Reinstall the bracket and retaining nut and bolt. Reconnect the clutch electrical connector.

## CHANGING COOLANT IN COOLING SYSTEM

The cooling system must be filled with a 50/50 solution of water and permanent ethylene glycol anti-freeze. After every two years, drain the coolant from the radiator, reservoir expansion tank and engine by opening the drain cock and block plug. After coolant is drained, flush the entire system and refill it with a 50/50 solution of water and anti-freeze. Capacity of cooling system is approximately 7 quarts (6.4 l). When filling, fill the radiator completely and fill the expansion tank to between the marks. **DO NOT OVERFILL.** Always install radiator cap securely.

# ELECTRICAL MAINTENANCE

## SERVICING BATTERY

**IMPORTANT:** Before welding on the machine, disconnect ground cable from the battery to prevent damage to the electrical system.

**Note:** Check battery condition weekly or after every 50 hours of operation. Keep terminals and entire battery case clean because a dirty battery will slowly discharge. To clean the battery, wash the entire case with solution of baking soda and water. Rinse with clear water. Coat the battery posts and cable connectors with Grafo 112X (Skin-over) grease, Toro Part No. 505-47 or petroleum jelly to prevent corrosion.

## WIRING HARNESS SERVICE

Prevent corrosion of wiring terminals by applying Grafo 112X (Skin-over) grease, Toro Part No. 505-47, to the inside of all harness connectors whenever the harness is replaced.

Whenever working with the electrical system, always disconnect battery cables, negative (-) cable first, to prevent possible wiring damage from short-outs.

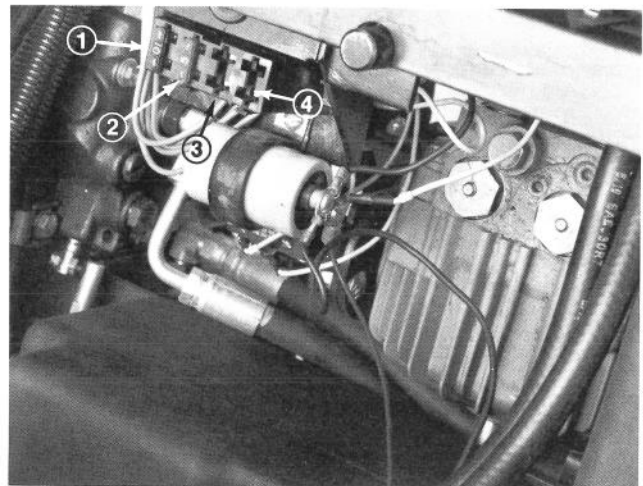

Figure 43

1. Accessories fuse (5 amp)
2. Safety switches fuse (5 amp)
3. Main fuse (7.5 amp)
4. Spare fuse (7.5 amp)

## FUSES

Fuses are accessible under the seat plate (Fig. 43).

# HYDRAULIC SYSTEM MAINTENANCE

## ADJUSTING TRANSMISSION FOR NEUTRAL

The machine must not creep when traction pedal is released. If it does creep, an adjustment is required.

1. Park machine on a level surface and shut engine off. Depress only the right brake pedal and engage the parking brake.
2. Jack up left front side of machine until tire is off shop floor. Support machine with jack stands to

prevent it from falling accidentally.

3. Lift seat. Visually inspect traction linkage for possible binding condition, correct if necessary and check machine operation. If condition still exists, repeat steps 1 and 2 and proceed to step 4.
4. Loosen two locknuts securing pump plate so plate is free to move (Fig. 44).
5. Start engine and rotate pump plate (Fig. 44) in either direction until wheel ceases rotation.

# HYDRAULIC SYSTEM MAINTENANCE

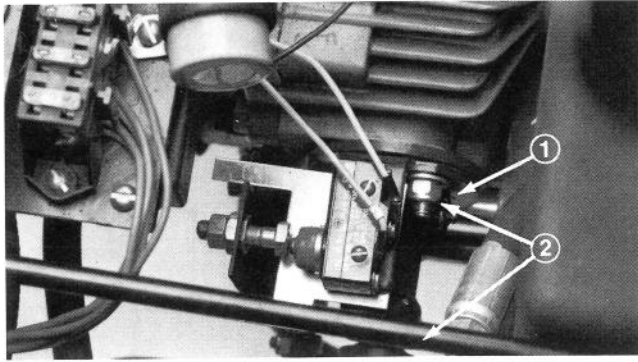

Figure 44

1. Pump plate 2. Locknut

6. Stop engine and tighten locknuts to secure pump plate (Fig. 44).
7. Start engine and check adjustment. Repeat adjustment, if necessary.
8. Stop the engine and release right brake. Remove jack stands and lower machine to the shop floor. Test drive the machine to be sure it does not creep.

## CHANGING HYDRAULIC OIL AND FILTER

Initially, replace the hydraulic system oil and filter after the first full days' operation — NOT TO EXCEED 10 HOURS. Replace the oil and filter every 250 hours operation, or yearly, whichever comes first thereafter. The hydraulic system is designed to operate on any high quality detergent oil having the American Petroleum Institute — API — "service classification" SF/CC or CD. Oil viscosity — weight — must be selected according to anticipated ambient temperature for the season in which product will be used.

Temperature/viscosity recommendations are:

Expected Ambient Temperature	Recommended Viscosity and Type
(Extreme) over 90°F	SAE 30, Type SF/CC or CD engine oil.
(Normal) 40-100° F	SAE 10W-30 or 10W-40, Type SF/CC or CD engine oil.
(Cool — Spring/Fall) 30-50° F	SAE 5W-30, Type SF/CC or CD engine oil.
(Winter) Below 30° F	Type "F" or "FA" ATF Automatic Transmission Fluid.

**Note:** Do not mix engine oil and automatic transmission fluid or hydraulic system component damage may result. When changing fluids, also change transmission filter. **DO NOT USE DEXTRON II ATF.**

**Note:** Fluid to operate the power steering is supplied by the hydraulic system transmission charge pump.

Cold weather start-up may result in "stiff" operation of the steering until the hydraulic system has warmed up. Using proper weight hydraulic oil in system will minimize this condition.

The axle housing acts as the reservoir for the system. The transmission and axle housing are shipped from the factory with approximately 5 quarts (4.7 l) of SAE 10W-30 engine oil. However, check level of transmission oil before engine is first started and daily thereafter.

1. Lower cutting unit to shop floor, set parking brake, and turn engine OFF. Block the two rear wheels.
2. Jack up both sides of the front axle and support it with jackstands.
3. Clean the area around the hydraulic oil filter and remove the filter (Fig. 45).

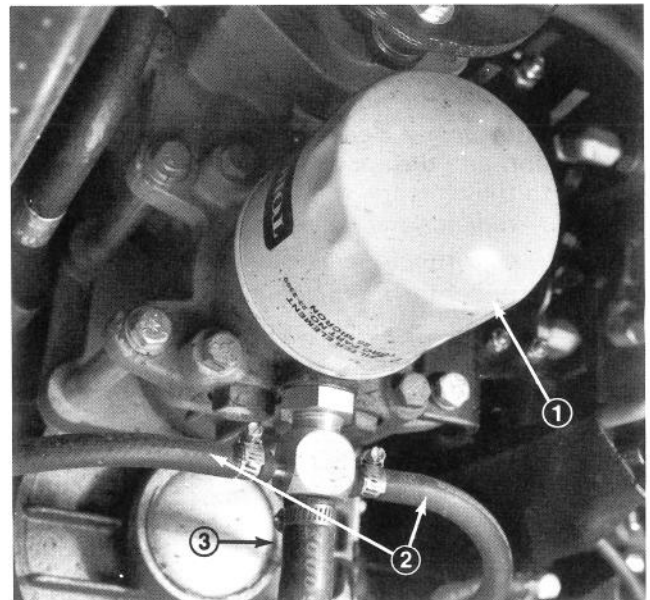

Figure 45

1. Hydraulic system filter 3. Suction line  
2. Hydraulic return lines

4. Remove the tube that connects the axle housing to the transmission and allow the oil to flow into a drain pan.
5. Install new hydraulic oil filter and connect the tube between axle housing and transmission. Fill axle (reservoir) to proper level (approx. 5 qt); refer to Check Hydraulic System Fluid. Remove the jack stands.
6. Start engine, cycle steering and lift cylinders, and check for oil leaks. Allow engine to run for about five minutes. Then shut engine off.
7. After two minutes, check level of transmission fluid; refer to Check Hydraulic System Fluid.

# PRODUCT IDENTIFICATION

The traction unit has two identification numbers: a model number and a serial number that are stamped into a plate. The identification plate is located near the left brake pedal on the frame (Fig. 46). In any correspondence concerning the traction unit, supply the model and serial numbers to ensure correct information and replacement parts are obtained.

To order replacement parts from an Authorized TORO Distributor supply the following information:

1. Model and serial numbers of the traction unit.
2. Part number, description and quantity of parts desired.

**Note:** Do not order by reference number if a parts catalog is being used; use the part number.

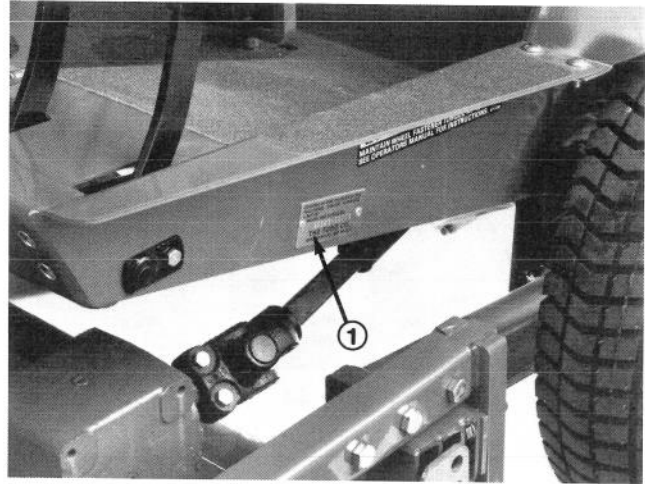

Figure 46

1. Model and serial ID plate

## PREPARATION FOR SEASONAL STORAGE

### Traction Unit

1. Thoroughly clean the traction unit, cutting unit and the engine, paying special attention to these areas:
  - radiator and radiator screen
  - underneath the cutting unit
  - under the cutting unit belt covers
  - counterbalance springs
  - P.T.O. Shaft Assembly
  - all grease fittings and pivot points
  - remove control panel and clean out inside of the control box
  - beneath seat plate and top of transmission
2. Check the tire pressure. Inflate all traction unit tires to 10 to 15 psi (69 to 103 kPa).
3. Remove, sharpen and balance the cutting unit's blades. Reinstall the blades and torque the blade fasteners to 85-110 ft-lb (115-149 N·m).
4. Check all fasteners for looseness; tighten as necessary.
5. Grease or oil all grease fittings, pivot points, and transmission by-pass valve pins. Wipe off any excess lubricant.
6. Lightly sand and use touch up paint on painted areas that are scratched, chipped or rusted. Repair any dents in the metal body.
7. Service the battery and cables as follows:
  - a. Remove the battery terminals from the battery posts.

- b. Clean the battery, terminals and posts with a wire brush and baking soda solution.
- c. Coat the cable terminals and battery posts with Grafo 112X skin-over grease (Toro Part Number 505-47), or petroleum jelly to prevent corrosion.
- d. Slowly recharge the battery for 24 hours every 60 days to prevent lead sulfation of the battery.

### Engine

1. Drain the engine oil from the oil pan and replace the drain plug.
2. Remove and discard the oil filter. Install a new filter.
3. Refill the engine with 3.8 quarts (3.6 L) of recommended motor oil. Refer to Changing Crankcase Oil.
4. Start the engine and run at idle speed for two minutes.
5. Drain diesel fuel from the fuel tank, fuel lines, pump, filter and separator. Flush fuel tank with clean diesel fuel and connect all fuel lines.
6. Thoroughly clean and service the air cleaner assembly.
7. Seal the air cleaner inlet and the exhaust outlet with weatherproof masking tape.
8. Check the oil filler cap and fuel tank cap to ensure they are securely in place.

# SERVICE INTERVAL CHART

Date								
Hour Meter Reading								
Service Interval	↓	Daily	5	10	25	50	75	100
Clean Radiator Screen	Daily							
Check Interlock System	Daily							
Check Engine Oil Level	Daily							
Check Transmission Oil Level	Daily							
Check Radiator and Coolant (more often when conditions are dirty)	Daily							
Check Water Separator	Daily							
Replace Hydraulic Oil and Oil Filter (Initial)	Within 10							
Tighten Front Wheel Nuts (Initial)	2 & 10							
Check Brakes and Lubricate Cables	25							
Check Hoses, Lines, Fittings & Pump for Leaks	25							
Check Tire Pressure (12 psi - 83 kPa)	25							
Lubricate Grease Fittings & Oil	25							
Change Engine Oil Filter (Initial)	50							
Change Engine Oil	50							
Service Air Cleaner (Dust Cup & Baffle) (more often when conditions are dirty)	50							
Check Battery	50							
Check and Adjust PTO Drive Belt	50							
Change Engine Oil Filter (Regular)	100							
Check Engine Fan and Alternator Belt	100							
Check and Adjust Electric Clutch Gap	100							
Tighten Front Wheel Nuts	250							
Service Air Cleaner (Filter)	250							
Change Transmission Oil and Filter	250							
Check Steering	250							
Check Rear Wheel Toe-In	250							
Replace Fuel Filter	400							
Replace Fuel Pump Filter	400							
Check Fuel Lines and Connections	400							
Drain and Clean Fuel Tank	400							
Pack Rear Wheel Bearings	500							
Grease Transmission By-Pass Pins	500							
Replace all Interlock Switches (2 years)	1000							
Drain and Flush Cooling System (2 years)	1000							

Engine Oil: Use 10W-30 CD  
 Engine Oil Filter — Toro part no. 67-4330  
 Hydraulic System Fluid — 5 quarts (4.73 L) of SAE 10W-30 engine oil  
 Hydraulic Oil Filter — Toro part no. 23-2300

# SERVICE INTERVAL CHART

Date								
Hour Meter Reading								
Service Interval	↓	Daily	5	10	25	50	75	100
Clean Radiator Screen	Daily							
Check Interlock System	Daily							
Check Engine Oil Level	Daily							
Check Transmission Oil Level	Daily							
Check Radiator and Coolant (more often when conditions are dirty)	Daily							
Check Water Separator	Daily							
Replace Hydraulic Oil and Oil Filter (Initial)	Within 10							
Tighten Front Wheel Nuts (Initial)	2 & 10							
Check Brakes and Lubricate Cables	25							
Check Hoses, Lines, Fittings & Pump for Leaks	25							
Check Tire Pressure (12 psi - 83 kPa)	25							
Lubricate Grease Fittings & Oil	25							
Change Engine Oil Filter (Initial)	50							
Change Engine Oil	50							
Service Air Cleaner (Dust Cup & Baffle) (more often when conditions are dirty)	50							
Check Battery	50							
Check and Adjust PTO Drive Belt	50							
Change Engine Oil Filter (Regular)	100							
Check Engine Fan and Alternator Belt	100							
Check and Adjust Electric Clutch Gap	100							
Tighten Front Wheel Nuts	250							
Service Air Cleaner (Filter)	250							
Change Transmission Oil and Filter	250							
Check Steering	250							
Check Rear Wheel Toe-In	250							
Replace Fuel Filter	400							
Replace Fuel Pump Filter	400							
Check Fuel Lines and Connections	400							
Drain and Clean Fuel Tank	400							
Pack Rear Wheel Bearings	500							
Grease Transmission By-Pass Pins	500							
Replace all Interlock Switches (2 years)	1000							
Drain and Flush Cooling System (2 years)	1000							

Engine Oil: Use 10W-30 CD

Engine Oil Filter — Toro part no. 67-4330

Hydraulic System Fluid — 5 quarts (4.73 L) of SAE 10W-30 engine oil

Hydraulic Oil Filter — Toro part no. 23-2300

# SERVICE INTERVAL CHART

Date								
Hour Meter Reading								
Service Interval	↓	Daily	5	10	25	50	75	100
Clean Radiator Screen	Daily							
Check Interlock System	Daily							
Check Engine Oil Level	Daily							
Check Transmission Oil Level	Daily							
Check Radiator and Coolant (more often when conditions are dirty)	Daily							
Check Water Separator	Daily							
Replace Hydraulic Oil and Oil Filter (Initial)	Within 10							
Tighten Front Wheel Nuts (Initial)	2 & 10							
Check Brakes and Lubricate Cables	25							
Check Hoses, Lines, Fittings & Pump for Leaks	25							
Check Tire Pressure (12 psi - 83 kPa)	25							
Lubricate Grease Fittings & Oil	25							
Change Engine Oil Filter (Initial)	50							
Change Engine Oil	50							
Service Air Cleaner (Dust Cup & Baffle) (more often when conditions are dirty)	50							
Check Battery	50							
Check and Adjust PTO Drive Belt	50							
Change Engine Oil Filter (Regular)	100							
Check Engine Fan and Alternator Belt	100							
Check and Adjust Electric Clutch Gap	100							
Tighten Front Wheel Nuts	250							
Service Air Cleaner (Filter)	250							
Change Transmission Oil and Filter	250							
Check Steering	250							
Check Rear Wheel Toe-In	250							
Replace Fuel Filter	400							
Replace Fuel Pump Filter	400							
Check Fuel Lines and Connections	400							
Drain and Clean Fuel Tank	400							
Pack Rear Wheel Bearings	500							
Grease Transmission By-Pass Pins	500							
Replace all Interlock Switches (2 years)	1000							
Drain and Flush Cooling System (2 years)	1000							

Engine Oil: Use 10W-30 CD  
 Engine Oil Filter — Toro part no. 67-4330  
 Hydraulic System Fluid — 5 quarts (4.73 L) of SAE 10W-30 engine oil  
 Hydraulic Oil Filter — Toro part no. 23-2300

# The Toro Promise

## A LIMITED WARRANTY

*The Toro Company promises to repair your Model 30223 TORO GROUNDSMASTER® MOWER, and its originally purchased cutting unit, if defective in materials or workmanship. The following time periods from the date of purchase apply:*

Model 30223 . . . . . Two Years or 1500 operational hours,  
whichever comes first.

*The costs of parts, labor and transportation are included.*

If you feel your TORO product is defective and wish to rely on The Toro Promise, the following procedure is recommended:

1. Contact your Authorized TORO Distributor or Commercial Dealer (the Yellow Pages of your telephone directory is a good reference source).
2. The TORO Distributor or Commercial Dealer will advise you on the arrangements that can be made to inspect and repair your product.
3. The TORO Distributor or Commercial Dealer will inspect the product and advise you whether the product is defective and, if so, make all repairs necessary to correct the defect without an extra charge to you.

If for any reason you are dissatisfied with the distributor's analysis of the defect or the service performed, you may contact us.

Write:

TORO Commercial Products Service Department  
8111 Lyndale Avenue South  
Minneapolis, Minnesota 55420

The above remedy of product defects through repair by an Authorized TORO Distributor or Commercial Dealer is the purchaser's sole remedy for any defect.

THERE IS NO OTHER EXPRESS WARRANTY. ALL IMPLIED WARRANTIES OF MERCHANTABILITY AND FITNESS FOR USE ARE LIMITED TO THE DURATION OF THE EXPRESS WARRANTY.

Some states do not allow limitations on how long an implied warranty lasts, so the above limitation may not apply to you.

This Warranty applies only to parts or components which are defective and does not cover repairs necessary due to normal wear, misuse, accidents, or lack of proper maintenance. Regular, routine maintenance of the unit to keep it in proper condition is the responsibility of the owner.

All warranty repairs reimbursable under the Toro Promise must be performed by an Authorized TORO Commercial Dealer or Distributor using Toro approved replacement parts.

Repairs or attempted repairs by anyone other than an Authorized TORO Distributor or Commercial Dealer are not reimbursable under the Toro Promise. In addition, these unauthorized repair attempts may result in additional malfunctions, the correction of which is not covered by warranty. This warranty shall be declared void if the owner removes, disconnects, or in any way alters the operation of the products hour meter.

THE TORO COMPANY IS NOT LIABLE FOR INDIRECT, INCIDENTAL OR CONSEQUENTIAL DAMAGES IN CONNECTION WITH THE USE OF THE PRODUCT INCLUDING ANY COST OR EXPENSE OF PROVIDING SUBSTITUTE EQUIPMENT OR SERVICE DURING PERIODS OF MALFUNCTION OR NON-USE.

Some states do not allow the exclusion or limitation of incidental or consequential damages, so the above limitation or exclusion may not apply to you.

This warranty gives you specific legal rights, and you may also have other rights which vary from state to state.

### COUNTRIES OTHER THAN THE UNITED STATES OR CANADA

Customers who have purchased TORO products exported from the United States or Canada should contact their TORO Distributor (Dealer) to obtain guarantee policies for your country, province or state. If for any reason you are

dissatisfied with your Distributor's service or have difficulty obtaining guarantee information, contact the TORO importer. If all other remedies fail, you may contact us at The Toro Company.