



22in Cordless Hedge Trimmer

Model No. 51494—Serial No. 313000001 and Up

Model No. 51494T—Serial No. 313000001 and Up

Operator's Manual

Model 51494T does not include a battery or a charger.



If you have questions or problems, contact us at www.Toro.com or call toll free 1-800-237-2654 (US) or 1-800-248-3258 (Canada) before returning this product.

General Power Tool Safety Warnings

▲ WARNING

CALIFORNIA Proposition 65 Warning

Battery posts, terminals, and related accessories contain lead and lead compounds, chemicals known to the State of California to cause cancer and reproductive harm.
Wash hands after handling.



WARNING Read all safety warnings and all instructions. Failure to follow the warnings and instructions may result in electric shock, fire, and/or serious injury.

Save all warnings and instructions for future reference.

The term "power tool" in all of the warnings listed below refers to your mains-operated (corded) power tool or battery-operated (cordless) power tool.

1. Work area safety

- Keep work area clean and well lit.** Cluttered or dark areas invite accidents.
- Do not operate power tools in explosive atmospheres, such as in the presence of flammable liquids, gases or dust.** Power tools create sparks which may ignite the dust or fumes.
- Keep children and bystanders away while operating a power tool.** Distractions can cause you to lose control.

2. Electrical safety

- Power tool plugs must match the outlet. Never modify the plug in any way. Do not use any**

adapter plugs with earthed (grounded) power tools. Unmodified plugs and matching outlets will reduce risk of electric shock.

- Avoid body contact with earthed or grounded surfaces such as pipes, radiators, ranges and refrigerators.** There is an increased risk of electric shock if your body is earthed or grounded.
- Do not abuse the cord. Never use the cord for carrying, pulling or unplugging the power tool. Keep cord away from heat, oil, sharp edges or moving parts.** Damaged or entangled cords increase the risk of electric shock.
- Do not expose power tools to rain or wet conditions.** Water entering a power tool will increase the risk of electric shock.
- If operating a power tool in a damp location is unavoidable, use a supply protected by a residual current device (RCD) in AUS or a ground fault interrupt (GFI) in the USA.** Use of an RCD or GFI reduces the risk of electric shock.

3. Personal safety

- Stay alert; watch what you are doing and use common sense when operating a power tool. Do not use a power tool while you are tired or under the influence of drugs, alcohol or medication.** A moment of inattention while operating power tools may result in serious personal injury.
- Use personal protective equipment. Always wear eye protection.** Protective equipment such as dust mask, non-skid safety shoes, hard hat, or hearing protection used for appropriate conditions will reduce personal injuries.
- Prevent unintentional starting. Ensure the switch is in the off-position before connecting to power source and/or battery pack, picking up or carrying the tool. Carrying power tools with your finger on the switch or energizing power tools that have the switch on invites accidents.**
- Remove any adjusting key or wrench before turning the power tool on.** A wrench or a key left attached to a rotating part of the power tool may result in personal injury.



- E. **Do not overreach. Keep proper footing and balance at all times.** *This enables better control of the power tool in unexpected situations.*
- F. **Dress properly. Do not wear loose clothing or jewelry. Keep your hair, clothing and gloves away from moving parts.** *Loose clothes, jewelry, or long hair can be caught in moving parts.*
4. **Power tool use and care**
- A. **Do not force the power tool. Use the correct power tool for your application.** *The correct power tool will do the job better and safer at the rate for which it was designed.*
- B. **Do not use the power tool if the switch does not turn it on and off.** *Any power tool that cannot be controlled with the switch is dangerous and must be repaired.*
- C. **Disconnect the battery pack from the power tool before making any adjustments, changing accessories, or storing power tools.** *Such preventive safety measures reduce the risk of starting the power tool accidentally.*
- D. **Store idle power tools out of the reach of children and do not allow persons unfamiliar with the power tool or these instructions to operate the power tool.** *Power tools are dangerous in the hands of untrained users.*
- E. **Maintain power tools. Check for misalignment or binding of moving parts, breakage of parts and any other condition that may affect the power tools operation. If damaged, have the power tool repaired before use.** *Many accidents are caused by poorly maintained power tools.*
- F. **Keep cutting tools sharp and clean.** *Properly maintained cutting tools with sharp cutting edges are less likely to bind and are easier to control.*
- G. **Use the power tool, accessories and tool bits etc. in accordance with these instructions, taking into account the working conditions and the work to be performed..** *Use of the power tool for operations different from those intended could result in a hazardous situation.*
5. **Battery tool use and care**
- A. **Recharge only with the charger specified by the manufacturer.** *A charger that is suitable for one type of battery pack may create a risk of fire when used with another battery pack.*
- B. **Use power tools only with specifically designated battery packs.** *Use of any other battery packs may create a risk of injury and fire.*
- C. **When battery pack is not in use, keep it away from other metal objects, like paper clips, coins, keys, nails, screws, or other small metal objects that can make a connection from one terminal to another.** *Shorting the battery terminals together may cause burns or a fire.*
- D. **Under abusive conditions, liquid may be ejected from the battery; avoid contact. If contact accidentally occurs, flush with water. If liquid contacts eyes, additionally seek medical help.** *Liquid ejected from the battery may cause irritation or burns.*
- E. **Charging time will be increased if the battery is charged when the temperature is not between 0° C (32° F) and 40° C (104° F).**
6. **Service**
- Have your power tool serviced by a qualified repair person using only identical replacement parts.** *This will ensure that the safety of the power tool is maintained.*

Hedge Trimmer Safety Warnings

- **Use both hands when operating the hedge trimmer.** *Using one hand could cause loss of control and result in serious personal injury.*
- **Keep all parts of the body away from the cutter blade. Do not remove cut material or hold material to be cut when blades are moving. Make sure the switch is off when clearing jammed material. Blades coast after turn off. A moment of inattention while operating the hedge trimmer may result in serious personal injury.**
- **Carry the hedge trimmer by the handle with the cutter blade stopped.** *Proper handling of the hedge trimmer will reduce possible personal injury from the cutter blades.*
- **Hold the power tool by insulated gripping surfaces only, because the cutter blade may contact hidden wiring or its own cord. Cutter blades contacting a "live" wire may make exposed metal parts of the power tool "live" and could give the operator an electric shock.**
- **DANGER – Keep hands away from blade.** *Contact with blade will result in serious personal injury.*

Safety and Instructional Decals

Safety decals and instructions are easily visible to the operator and are located near any area of potential danger. Replace any decal that is damaged or lost.

Symbol	Name	Designation/Explanation
DC	Direct current	Type of current
A	Amperes	Current
Hz	Hertz	Frequency (cycles per second)
SPM	Strokes per minute	Speed of blade
V	Volts	Voltage

WARNING
TO REDUCE THE RISK OF INJURY,
USER MUST READ INSTRUCTION MANUAL.
Do not expose to rain. Use only Toro battery model 88502.

AVERTISSEMENT POUR RÉDUIRE LES RISQUES DE
BLESSURES, LISEZ ATTENTIVEMENT LE MANUEL DE L'UTILISATEUR.
Ne l'exposez pas à la pluie. Utilisez uniquement avec batterie TORO 88502.

20V MAX* DC \approx 22" / 560mm Dual Action / Double Action Cutting Capacity: 9/16" /
Capacité de coupe : 14.3mm

*Maximum initial voltage without workload, as rated by battery
manufacturer. Under workload, nominal voltage is 18V.
*Tension initiale maximale sans charge, telle qu'indiquée par le fabricant
de la batterie. Mesurée sous charge, la tension nominale est de 18 V.

1    

Model: 51494
Modèle : 
Serial Number: 
Numéro de série : 
Date Code: 
Code de date : 

 Country of Origin: China / Pays d'origine : Chine
218549 THE TORO COMPANY
GARDENING 8111 Lyndale Avenue South
APPLIANCES Bloomington, MN 55420-1196 USA

125-3277

Model 51494

1. Warning—read the *Operator's Manual*; do not operate in wet conditions; wear eye protection.

TORO

LITHIUM-ION BATTERY CHARGER
CHARGEUR BATTERIE LITHIUM-ION
Input: 100-120V AC, 50-60Hz, 70W
Output: 18V MAX* DC \approx 2.6A



*Maximum initial voltage without workload, as rated
by battery manufacturer. Under workload, nominal
voltage is 18V DC \approx .
*Tension initiale maximale sans charge, telle qu'indiquée
par le fabricant de la batterie. Mesurée sous charge,
la tension nominale est de 18 V DC \approx .

1  To reduce the risk of injury,
user must read the instruction
manual. Use only with 88502 Lithium-ion Battery Pack.
FOR INDOOR USE ONLY.

AVERTISSEMENT Pour réduire
le risque de
blessures, l'utilisateur doit lire le manuel d'utilisation.
Utiliser uniquement avec 88502 Lithium-ion Battery
Pack. POUR UN USAGE INTÉRIEUR.

Backfeed Protection / Protection contre le retour d'énergie

THE TORO COMPANY
8111 Lyndale Avenue South
Bloomington, MN 55420-1196 USA
Country of Origin: China / Pays d'origine : Chine
Manufactured by CHANGZHOU GLOBE CO.,LTD
Fabriqué par CHANGZHOU GLOBE CO.,LTD

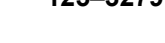
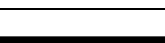
Model: 88500 SL
Modèle : 
Serial Number: 
Numéro de série : 
Date Code: 
Code de date : 

 LISTED
E19957
Class 2 Battery Charger
40H6
Chargeur de batterie Classe 2



125-3279

WARNING
TO REDUCE THE RISK OF INJURY,
USER MUST READ INSTRUCTION MANUAL.
Do not expose to rain. Use only Toro battery model 88502.

AVERTISSEMENT POUR RÉDUIRE LES RISQUES DE
BLESSURES, LISEZ ATTENTIVEMENT LE MANUEL DE L'UTILISATEUR.
Ne l'exposez pas à la pluie. Utilisez uniquement avec batterie TORO 88502.

20V MAX* DC \approx 22" / 560mm Dual Action / Double Action Cutting Capacity: 9/16" /
Capacité de coupe : 14.3mm

*Maximum initial voltage without workload, as rated by battery
manufacturer. Under workload, nominal voltage is 18V.
*Tension initiale maximale sans charge, telle qu'indiquée par le fabricant
de la batterie. Mesurée sous charge, la tension nominale est de 18 V.

1    

Model: 51494T
Modèle : 
Serial Number: 
Numéro de série : 
Date Code: 
Code de date : 

 Country of Origin: China / Pays d'origine : Chine
218549 THE TORO COMPANY
GARDENING 8111 Lyndale Avenue South
APPLIANCES Bloomington, MN 55420-1196 USA

121-7659

Model 51494T



1. Warning—read the *Operator's Manual*; do not operate in wet conditions; wear eye protection.

TORO 20V MAX* DC \approx 36Wh
Li-Ion Battery / Batterie au lithium-ion

*Maximum initial voltage without workload, as rated by battery
manufacturer. Under workload, nominal voltage is 18V DC \approx .
*Tension initiale maximale sans charge, telle qu'indiquée par le
fabricant de la batterie. Mesurée sous charge, la tension nominale
est de 18 V DC \approx .

1  To reduce the risk of injury, user
must read the instruction manual.
Wear eye protection. Do not short
terminals. Do not throw into fire. Use only with Toro battery charger
88500. When charging make sure temperature is between 0° to 40° C
(32° to 104° F), -15° to 50° C (5° to 122° F) for discharge. Risk of fire,
explosion and burns. Do not disassemble, crush, expose to heat above
100° C (212° F), or incinerate. Keep battery out of reach of children.

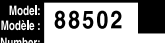
AVERTISSEMENT Pour réduire le
risque de blessures,
l'utilisateur doit lire le
manuel d'utilisation. Portez des lunettes de protection. Ne pas court-circuiter.
Ne jetez pas au feu. Utilisez uniquement avec chargeur de batterie Toro
88500. Lorsque vous chargez la batterie, assurez-vous que la température
est de 0 à 40 °C (32 à 104 °F), -15 à 50 °C (5 à 122 °F) pour la décharge.
Risque d'incendie, d'explosion et des brûlures. Ne pas démonter, écraser,
exposer à une température au-dessus de 100 °C (212 °F) ou incinérer.
Conservez la batterie hors de portée des enfants.

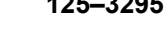
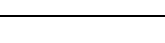
MH46448 Country of Origin: China / Pays d'origine : Chine
 Model: 88502
Modèle : 
Serial Number: 
Numéro de série : 
Date Code: 
Code de date : 



125-3295

TORO 20V MAX* LI-ION BATTERY
CHARGING PROCEDURE (LED INDICATOR)
PROCÉDURE DE CHARGEMENT (VOYANT DEL)

	RED / ROUGE	BATTERY IS CHARGING	BATTERIE EN CHARGE
	RED / ROUGE	FULLY CHARGED	PLEINE CHARGE
	RED / ROUGE	BATTERY IS TOO WARM: REMOVE FOR APPROX. 30 MINUTES TO ALLOW TO COOL	LA BATTERIE EST TROP CHAUDE: L'ENLEVER PENDANT ENVIRON 30 MINUTES POUR LA LAISSER REFROIDIR
	ORANGE / ORANGE	NO BATTERY PRESENT	AUCUNE BATTERIE PRÉSENTE
	RED / ROUGE	NO BATTERY PRESENT	AUCUNE BATTERIE PRÉSENTE
	GREEN / VERT	NO BATTERY PRESENT	AUCUNE BATTERIE PRÉSENTE
	RED BLINKING / ROUGE CLIGNOTANT	DEPECTIVE BATTERY: REMOVE AND REPLACE WITH NEW BATTERY IF THIS OCCURS	BATTERIE DÉFECTUEUSE : SI CELA SE PRODUIT, LA RETIRER ET LA REMPLACER PAR UNE NOUVELLE BATTERIE

DO NOT REMOVE THIS DECAL / NE PAS RETIRER CET AUTOCOLLANT

125-3293

Operation

Important: The battery pack is not fully charged when it is purchased. Before using the hedge trimmer for the first time, place the battery pack in the charger charge until the LED indicators turn green. Make sure to read all safety precautions. With regular use, it will need shorter charging time. If storing for a prolonged period of time, remove the battery. When ready to use again, charge the battery pack until the LED indicators turn green.

Starting the Hedge Trimmer

1. Remove the protective cover from the cutter blades (Figure 1).

⚠ WARNING

The hedge trimmer blades can cause cuts or amputation.

Be careful when handling the hedge trimmer with the protective cover removed.

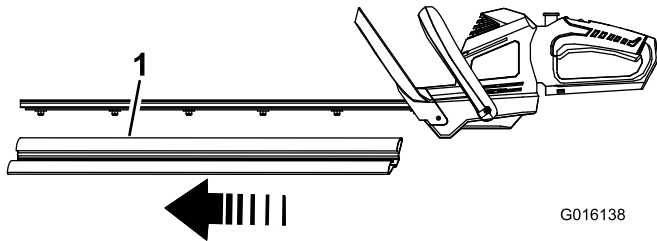

Figure 1

1. Protective cover

2. Align the tongue of the battery pack with the cavity in the handle housing (Figure 2).

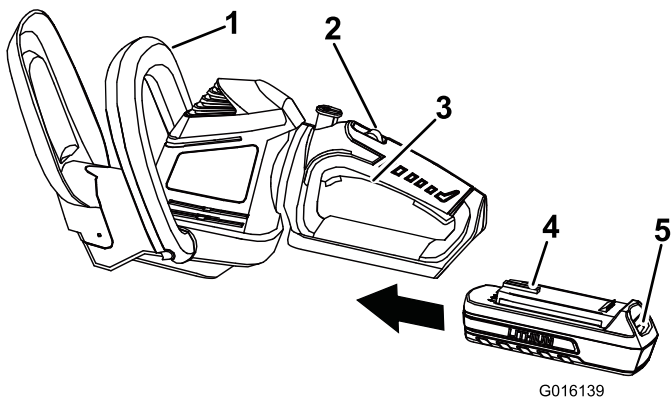

Figure 2

- | | |
|---------------------|-----------|
| 1. Auxiliary handle | 4. Tongue |
| 2. Lock switch | 5. Latch |
| 3. Trigger | |

3. Grasp the trigger handle (Figure 2).
4. Push the battery pack into the handle until the latch locks into place.

Important: The battery pack is not fully charged when it is purchased. Before using the hedge trimmer for the first time, place the battery pack in the charger charge until the LED indicators turn green. Make sure to read all safety precautions. With regular use, it will need shorter charging time. If storing for a prolonged period of time, remove the battery. When ready to use again, charge the battery pack until the LED indicators turn green.

5. Place one hand on the trigger handle. Place the other hand on the auxiliary handle (Figure 2).
6. Slide the lock switch backwards, towards you, then squeeze the trigger switch to turn on the hedge trimmer (Figure 2). The trimmer will stay on as long as the trigger switch is squeezed. Lock-off switch may be released once hedge trimmer is running (Figure 2).

Rotating the Hedge Trimmer Handle

1. Press and hold the rotational lock button.

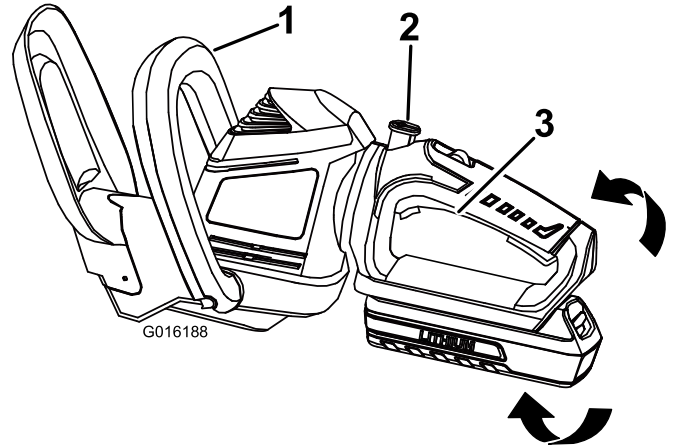

Figure 3

- | | |
|---------------------------|-----------|
| 1. Auxiliary handle | 3. Handle |
| 2. Rotational lock button | |

2. Rotate the handle to the right or left depending on desired cutting direction, then release the rotational lock button to lock the handle in the desired position.

Stopping the Hedge Trimmer

1. Release the trigger switch (Figure 2).
2. Allow at least 5 seconds for the cutting blade to stop moving.

Charging the Battery Pack

Important: For best results, your battery pack should be charged in a location where the temperature is more than 0° C (32° F) but less than 40° C (104° F). To reduce the risk of serious personal injury, do not store outside or in vehicles. Charging time will increase if it is not charged within this range.

1. Turn the battery upside down and line up the battery terminal with the slot in the charger (Figure 4 and Figure 5).

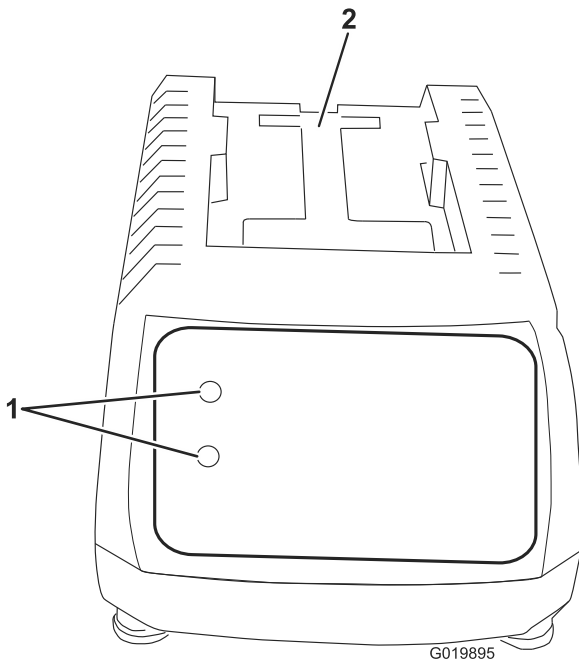

Figure 4

1. LED indicators 2. Insert battery here

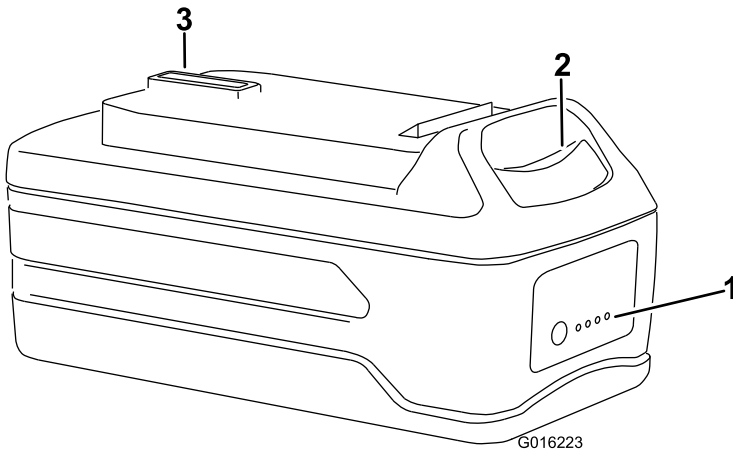

Figure 5

1. LED indicators (level of charge) 3. Battery terminal
 2. Release button
-
2. Slide the battery into the charger until it clicks into place.
 3. To remove the battery, press down on the release button and slide the battery backwards out of the charger.

4. Refer to the table below to interpret the LED indicators on the battery charger.

LED COLOR		
Top	Bottom	Indicates:
Red	Red	Battery is charging
Red	Green	Fully charged
Red	Orange	Battery is too warm: Remove for approximately 30 minutes
Red	Green	No battery present
Red (blinking)	Red (blinking)	Defective battery

Operating Tips

- The unit is used for cutting in either direction in a slow, sweeping action from side to side.
- Stand so that you are stable and balanced on both feet. Do not overreach.
- Inspect and clear the area of any hidden objects.
- Never use the hedge trimmer near power lines, fencing, posts, buildings, or other immovable objects.
- Never use a blade after hitting a hard object without first inspecting it for damage. Do not use if any damage is detected.
- Never touch blades or service unit with the power supply connected.
- Do not force the hedge trimmer through heavy shrubbery. This can cause the blades to bind and slow down. If the blades slow down, reduce the pace.
- Do not attempt to cut stems or twigs that are larger than 9/16 in., or those obviously too large to feed into the cutting blade. Use a non-powered hand saw or pruning saw to trim large stems.
- If blades do become jammed, stop the motor, allow the blades to stop, and remove the battery before attempting to remove the obstruction.
- If desired, you can use a string to help cut your hedge level. Decide how high you want the hedge. Stretch a piece of string along the hedge at the desired height. Trim the hedge just above the guide line of string.
- Trim the side of a hedge so that it will be slightly narrower at the top. More of the hedge will be exposed when shaped this way, and it will be more uniform.
- Wear gloves when trimming thorny or prickly growth. When trimming new growth, use a wide sweeping action, so that the stems are fed directly into the cutting blade.

Maintenance

Oiling the Trimmer Blade

Note: The trimmer blade should be oiled before and after each use.

1. Stop the motor and remove the battery.
2. Clean dirt and debris from the body of the hedge trimmer, using a damp cloth with a mild detergent.

Note: Do not use any strong detergents on the plastic housing or the handle. They can be damaged by certain aromatic oils such as pine and lemon, and by solvents such as kerosene.
3. Lay the hedge trimmer on a flat surface. Apply light weight machine oil along the edge of the top blade. If you will be using the hedge trimmer for an extended period of time, it is advisable to oil the blade during use.

Note: Do not oil while the hedge trimmer is running.

Preparing the Battery Pack for Recycling

⚠ WARNING

Before recycling, cover the battery pack's terminals with heavy-duty adhesive tape. Do not attempt to destroy or disassemble the battery pack or remove any of its components. Lithium-ion batteries must be recycled or disposed of properly at the nearest battery recycling facility.

Service

Should this item need service, take the product to your Authorized Toro Service Dealer. Your Toro Dealer is specially trained to repair Toro products and will ensure that your Toro stays "All" Toro.

Storage

- Clean all foreign material from the product.
- Store it in a well-ventilated place that is inaccessible to children.
- Keep away from corrosive agents such as garden chemicals and de-icing salts.

Troubleshooting

Using the battery when it is hot can reduce the operating time. The battery will automatically stop working when it is overheated to prevent damage to it. Remove the battery from the charger and allow it to cool before placing it back into the trimmer.

Using the battery when there is moisture on the leads can cause the trimmer to malfunction. Allow the battery to dry or wipe it dry before placing it back into the trimmer.

Notes:

The Toro Promise - Electric Products

A Two-Year Full Warranty for Residential Use for the United States and Canada

The Toro Company and its affiliate, Toro Warranty Company, pursuant to an agreement between them, jointly warrant this product for two years against defects in material or workmanship when used for normal residential purposes.*

If you think your Toro Product contains a defect in materials or workmanship, if you have questions or problems, and before returning this product call toll free:

Trimmers:

1-800-237-2654 (US)
1-800-248-3258 (Canada)

Blowers:

1-888-367-6631 (US)
1-888-430-1687 (Canada)
1-800-574-3312 (Mexico)

Snowthrowers:

1-800-808-2963 (US)
1-800-808-3072 (Canada)

To receive a replacement or repair, at our option, return the complete unit to the seller. United States and Canada customers may return their product, with proof of purchase, to any Authorized Service Dealer. United States customers may also return their product, with proof of purchase, postage prepaid, to the Toro Service Center, 5500 SE Delaware, Ankeny, IA 50021.

This warranty covers product defects only. **Neither The Toro Company nor Toro Warranty Company is liable for indirect, incidental, or consequential damages in connection with the use of the Toro Products covered by this warranty, including any cost or expense of providing substitute equipment or service during reasonable periods of malfunction or non-use pending completion of repairs under this warranty. Some states do not allow exclusions of incidental or consequential damages, so the above exclusions may not apply to you.** This warranty gives you specific legal rights, and you may also have other rights which vary from state to state.

Countries Other than the United States and Canada

Customers who have purchased Toro products exported from the United States or Canada should contact their Toro Distributor (Dealer) to obtain guarantee policies for your country, province, or state. If for any reason you are dissatisfied with your Distributor's service or have difficulty obtaining guarantee information, contact the Toro importer. If all other remedies fail, you may contact us at Toro Warranty Company.

Australian Consumer Law

Australian customers will find details relating to the Australian Consumer Law either inside the box or at your local Toro Dealer.

* Residential use means use of the product on the same lot as your home.

Part Number 374-0262 Rev. D