



Rake and Vac™, Super, and Ultra Blower/Vacuum

Model No. 51574—Serial No. 312000001 and Up

Model No. 51602—Serial No. 312000001 and Up

Model No. 51609—Serial No. 312000001 and Up

Operator's Manual

Register at www.Toro.com.



If you have questions or problems, call toll free 1-888-367-6631 (US), 1-888-430-1687 (Canada), or 1-800-574-3312 (Mexico) before returning this product.

IMPORTANT SAFETY INSTRUCTIONS

When using an electrical appliance, basic precautions should always be followed, including the following:

READ ALL INSTRUCTIONS BEFORE USING VAC/BLOWER

WARNING—To reduce the risk of fire, electric shock, or injury, follow these safety instructions.

To ensure maximum safety, best performance, and to gain knowledge of the appliance, it is essential that you or any other operator of the appliance read and understand the contents of this manual before operating the appliance. Pay particular attention to the safety alert symbol  which means CAUTION, WARNING or DANGER—personal safety instruction. Read and understand the instruction because it has to do with safety. **Failure to comply with these instructions may result in personal injury, risk of fire, or electrical shock.**

Do not leave the appliance when plugged in. Unplug from outlet when not in use and before servicing.

WARNING—To reduce the risk of electric shock, **do not** use the appliance on wet surfaces. **Do not** expose it to rain. Store it indoors.

Do not allow appliance to be used as a toy. Do not use near children. Do not let children use the appliance.

Use only as described in this manual. Use only manufacturer's recommended attachments.

Dress properly. Keep hair, loose clothing, fingers, and all parts of the body away from openings and moving parts. Be aware of the position of the blower and the air inlets during operation. Loose clothing, jewelry and hair can be drawn into the inlets (refer to the following figure) and may result in personal injury. Always wear substantial footwear, long pants, and eye protection.

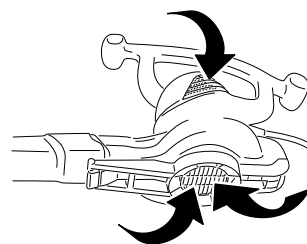

G017088

Caution—Moving Parts—do not operate the appliance without the air inlet guard in place. Refer to Setup for proper assembly instructions.

Do not use with damaged cord or plug. If appliance is not working as it should, has been dropped, damaged, left outdoors, or dropped into water, return it to a service dealer.

Do not pull or carry by cord, use cord as a handle, close a door on cord, or pull cord around sharp edges or corners. Keep cord away from heated surfaces.

Do not unplug by pulling on cord. To unplug, grasp the plug, not the cord.

Do not handle plug or appliance with wet hands.

Do not put any object into openings. Do not use with any opening blocked; keep free of dust, lint, hair, and anything that may reduce air flow.

Turn off all controls before unplugging.

Use extra care when cleaning on stairs.

Do not use to vacuum up flammable or combustible liquids, such as gasoline, or use in areas where they may be present.

This appliance is provided with double insulation. Use only identical replacement parts. See instructions for servicing of Double-Insulated Appliances.

Do not vacuum anything that is burning or smoking, such as cigarettes, matches, or hot ashes.

Do not use without vac bag or proper attachments in place.

SAVE THESE INSTRUCTIONS

Safety and Instructional Decals

Important: Safety and instruction decals are located near areas of potential danger. Replace damaged or lost decals.

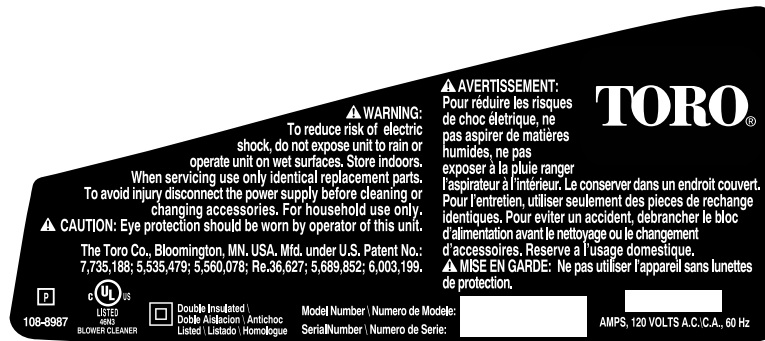

108-8987

Setup

Register your product at www.Toro.com to ensure that Toro can notify you in the case of a safety or warranty product recall.

Assembling the Blower

Important: The blower will not run unless the bottom inlet cover is locked in place.

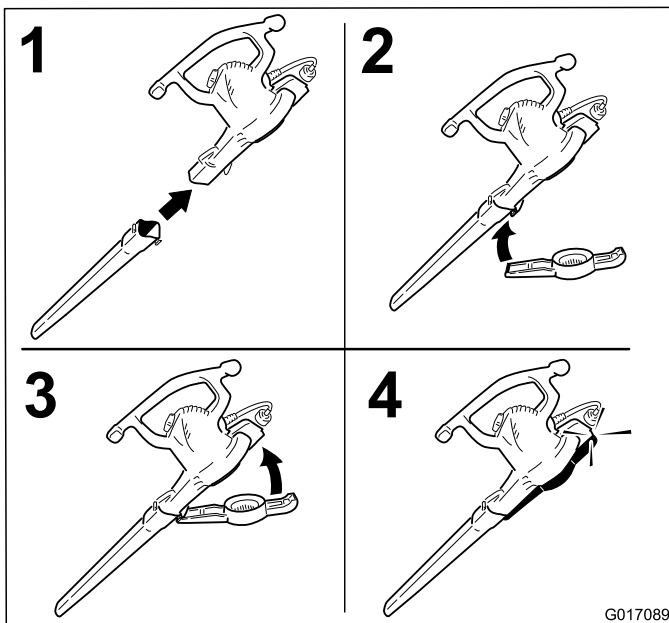

Converting from Blower to Vacuum

⚠ WARNING

The impeller rotates for a few seconds after you turn off the blower and can cut or injure fingers.

Do not remove the bottom inlet cover when the motor is running or when the unit is plugged into a power outlet.

1. Remove the inlet cover and the blower tube.

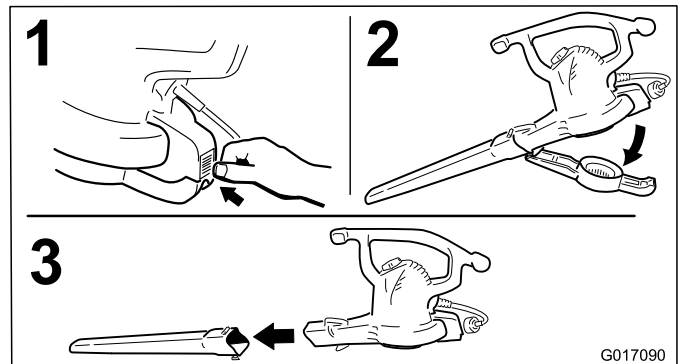

2. Install the vacuum tube and bag.

Important: The vacuum will not run unless the vacuum tube is locked in place.

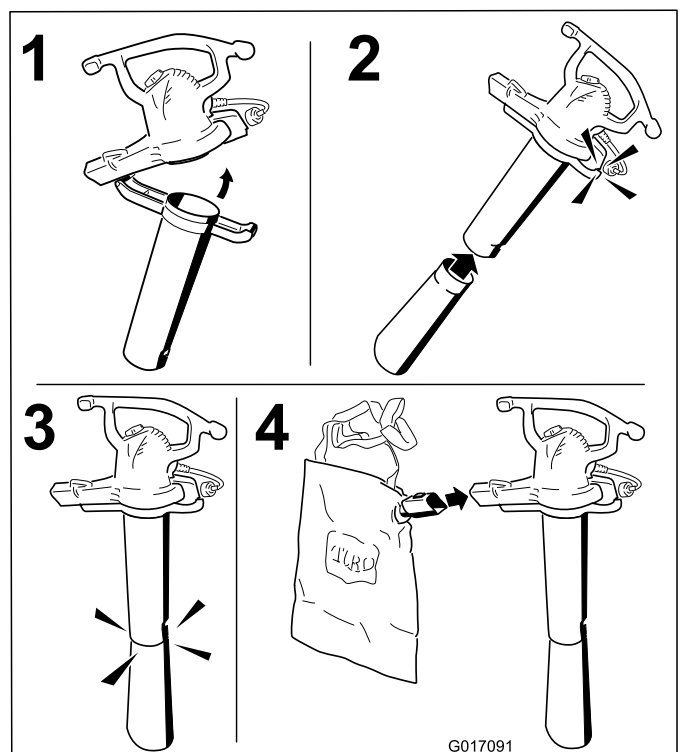

- Adjust the strap as needed for comfortable operation.

Converting from Vacuum to Blower

- Remove the vacuum bag and the vacuum tube.

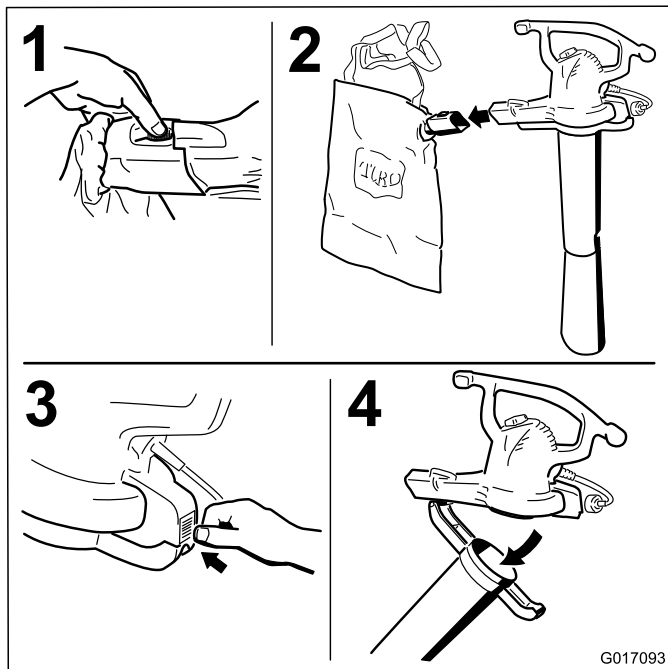

- Install the blower tube and inlet cover.

Important: The blower will not run unless the bottom inlet cover is locked in place.

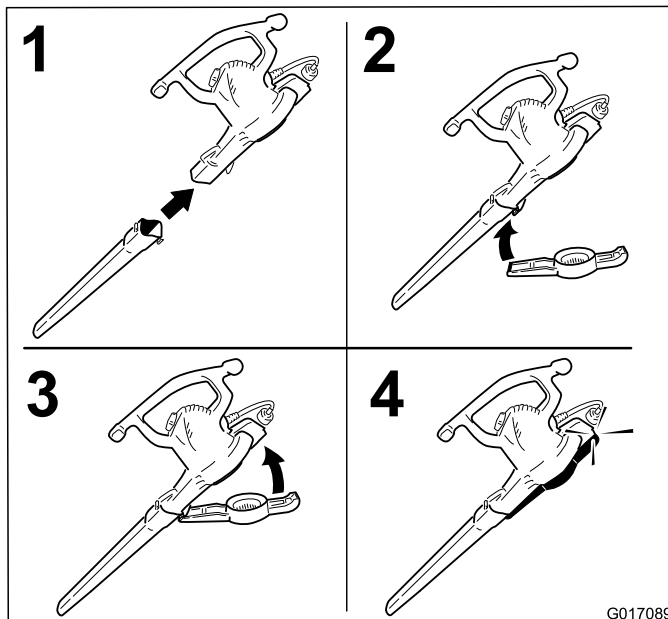

Operation

Important: This blower is intended for outdoor, residential use only. Do not use it indoors or for commercial or industrial purposes. This appliance is for household use only.

Connecting to a Power Source

To reduce the risk of electric shock, this appliance has a polarized plug (i.e., one blade is wider than the other). Use only a polarized, UL listed (CSA certified in Canada) extension cord recommended for outdoor use. A polarized plug will fit in a polarized cord only one way. If the plug does not fit fully in the cord, reverse the cord. If it still does not fit, purchase a polarized extension cord. If you have a polarized extension cord and the extension cord plug does not fit fully into the wall receptacle, reverse the plug. If it still does not fit, contact a qualified electrician to install the proper outlet. Do not change the appliance or extension cord plug in any way.

Use only an extension cord recommended for outdoor use.

⚠ WARNING

If you do not fully seat the extension cord on the inlet plug, or if the plug and cord do not fit firmly, the loose plug could lead to overheating and cause a fire, possibly burning you or others.

- Ensure that you fully seat the cord on the plug.
- Check the connection regularly to ensure that the cord is firmly attached.
- Do not use a worn-out or loose extension cord.

| Extension Cord Length | Minimum Wire Gage (A.W.G.) |
|-----------------------|----------------------------|
| 100 ft | 14 |
| 150 ft | 12 |

Note: Do not use an extension cord over 150 feet.

Important: Check the extension cord frequently during use for holes in the insulation. Do not use a damaged cord. Do not run the cord through standing water or wet grass.

Secure the extension cord to the blower cord using an overhand knot, as shown.

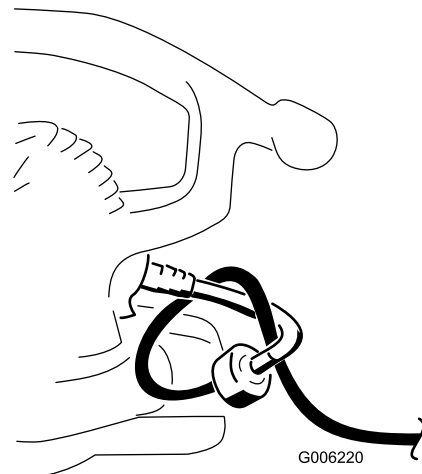

Starting/Stopping/Adjusting the Air Speed

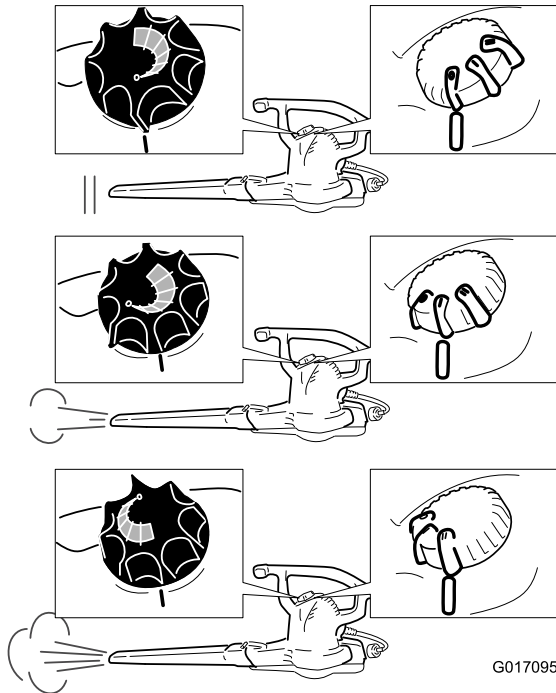

G017095

⚠ WARNING

The blower can throw debris, possibly causing serious personal injury to the operator or bystanders.

- Do not blow hard objects such as nails, bolts, or rocks.
- Do not operate the blower near bystanders or pets.
- Use extra care when cleaning debris from stairs or other tight areas.
- Wear safety goggles or other suitable eye protection, long pants, and shoes.

Using the Vacuum

⚠ WARNING

The vacuum can throw debris, possibly causing serious personal injury to the operator or bystanders.

- Do not operate the vacuum without the bag installed or with the bag zipper open.
- Do not vacuum sharp, pointed, or hard objects that could be thrown through the fabric of the bag, such as wires, staples, nails, or rocks.



G017098

Using the Nozzles

Install the power (Ultra and Super models only) and concentrator nozzles into the blower tube to help reach into narrow spaces or to remove matted debris from hard surfaces. On Ultra and Super blowers you can use the power nozzle without the concentrator for more power when blowing.

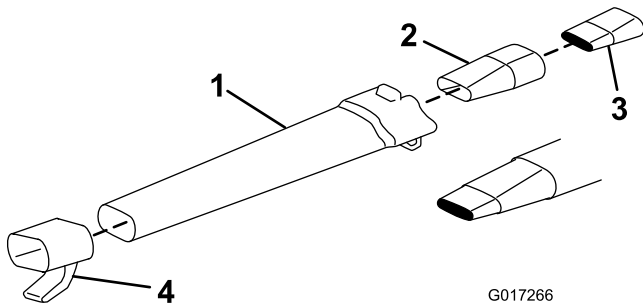

G017266

1. Blower tube
2. Power Nozzle (Ultra and Super Blowers only)
3. Concentrator nozzle
4. Cord wrap (Ultra Blower only; refer to Using the Cord Wrap)

Important: Vacuum only leaves and soft items. Hard items such as sticks, rocks, acorns, and pine cones will damage the impeller.

Important: Do not force the vacuum tube into a pile of debris or hold the tube upright while force feeding debris into the tube. Either action may clog and damage the impeller. If the vacuum starts to vibrate or make abnormal noise, stop it, **unplug** the cord, and check for the cause.

Using the Blower

The blower is intended for residential use only. Use the blower outdoors to move debris as needed.

Emptying the Bag

1. Turn off and unplug the vacuum from the power source.
2. Empty any debris from the bag.



G017099

Do not store debris in the bag. To clean the bag, turn it inside out and shake out any excess debris. Once a year, hand wash the bag in soapy water and allow it to air dry.

⚠ DANGER

Normal usage of the bag causes it to wear and deteriorate over time. A worn or deteriorated bag allows small objects to be thrown through the bag, possibly injuring the operator or bystanders.

Check the bag frequently. If it is worn or deteriorated, replace it with a genuine Toro vacuum bag.

Separating the Vacuum Tube

Models 51574 and 51602 only

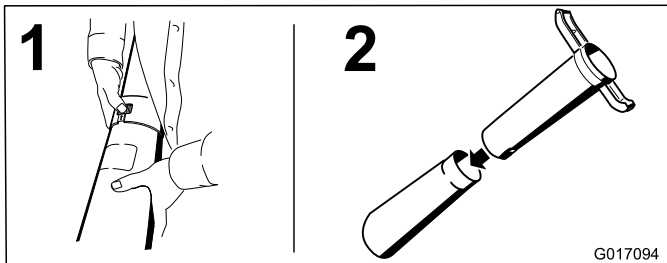

Removing Clogged Debris from the Impeller

1. Turn off and **unplug** the vacuum from the power source and wait for all moving parts to stop.
2. Remove the vacuum tube then remove the debris from impeller blades.

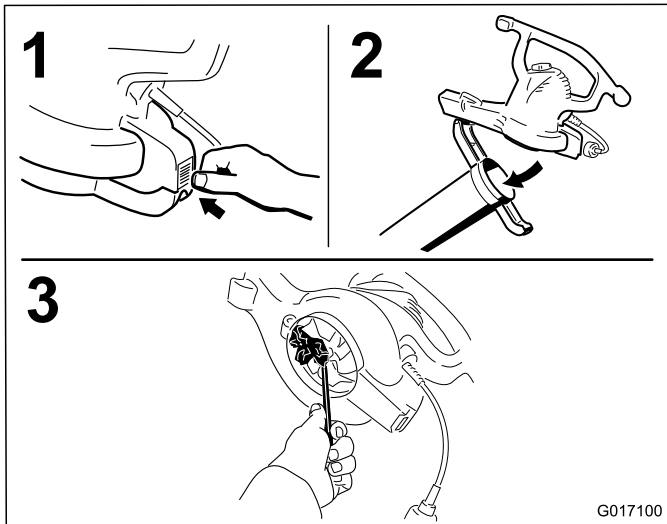

3. Check the impeller for any signs of damage. If it is damaged, contact your Authorized Toro Dealer.
4. Install the vacuum tube, or, if you want to switch to blower mode, the bottom inlet cover. Refer to Converting from Blower to Vacuum or Converting from Vacuum to Blower for more information.

Service

Toro has designed this product to give you years of trouble free use. Should it need service, bring the product to your Authorized Toro Service Dealer. Your Toro Dealer is specially trained to repair Toro products and will ensure that your Toro stays "All" Toro.

Double-insulated Appliances

In a double-insulated appliance, two systems of insulation are provided instead of grounding. No grounding means is provided on a double-insulated appliance, nor should a means for grounding be added to the appliance. Servicing a double-insulated appliance requires extreme care and knowledge of the system, and should be done only by the qualified service personnel at your Authorized Toro Service Dealer. Replacement parts for a double-insulated appliance must be identical to the parts they replace. A double-insulated appliance is marked with the words "Double Insulation" or "Double Insulated." The symbol (square within a square)  may also be marked on the appliance.

Storage

Store the blower/vacuum and extension cord indoors, in a cool dry location, out of reach of children and animals.

Using the Cord Wrap

Model 51609 only

Install the cord wrap as illustrated in Using the Nozzles (page 4). Wrap your extension cord (cord not provided) around the blower, as shown, for ease of storage.

Important: Always unplug the blower before wrapping the cord or storing it.

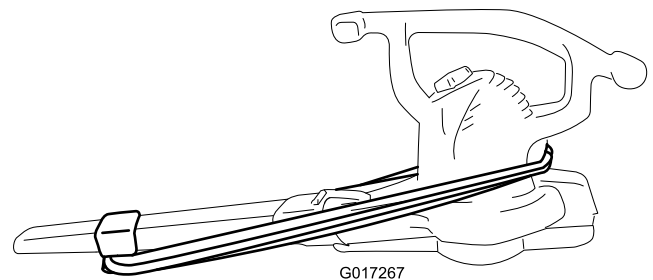

Troubleshooting

If your blower fails to run when you turn it on, check the following before contacting your Authorized Toro Service Dealer:

- Ensure that the bottom inlet cover or vacuum tube is locked in place.
- Ensure that the power cord is secured in place on the back of the blower and that the plug is fully seated.

The Toro Promise - Electric Blowers

A Two-Year Full Warranty for Residential Use for the United States, Canada, and Mexico

The Toro Company and its affiliate, Toro Warranty Company, pursuant to an agreement between them, jointly warrant this product for a period of two years from the date of original purchase against defects in material or workmanship when used for normal residential purposes.*

- If you have questions or problems, or before returning this product, call toll free: 1-888-367-6631 (US) or 1-888-430-1687 (Canada), or 1-800-574-3312 (Mexico).
- To receive a replacement or repair, at our option, return the complete unit to the seller. United States and Canada customers **only** may return their product, with proof of purchase, to any Authorized Service Dealer, or, postage prepaid to the Toro Service Center, 21350 Cedar Avenue S., Lakeville, MN 55044-9090.

This warranty covers product defects only. **Neither The Toro Company nor Toro Warranty Company is liable for indirect, incidental or consequential damages in connection with the use of the Toro Products covered by this warranty, including any cost or expense of providing substitute equipment or service during reasonable periods of malfunction or non-use pending completion of repairs under this warranty. Some states do not allow exclusions of incidental or consequential damages, so the above exclusions may not apply to you.** This warranty gives you specific legal rights, and you may also have other rights which vary from state to state.

Countries Other than the United States and Canada

Customers who have purchased Toro products exported from the United States, Canada, or Mexico should contact their Toro Distributor (Dealer) to obtain guarantee policies for your country, province, or state. If for any reason you are dissatisfied with your Distributor's service or have difficulty obtaining guarantee information, contact the Toro importer. If all other remedies fail, you may contact us at Toro Warranty Company.

* Residential use means use of the product on the same lot as your home.

Part Number 374-0065 Rev. B