



Turf Sweeper 4800

Model No. 44044—Serial No. 28000001 and Up

Operator's Manual



Warning



The engine exhaust from this product contains chemicals known to the State of California to cause cancer, birth defects, or other reproductive harm.

Important The engine in this product is not equipped with a spark arrester muffler. It is a violation of California Public Resource Code Section 4442 to use or operate this engine on any forest-covered, brush-covered, or grass-covered land as defined in CPRC 4126. Other states or federal areas may have similar laws.

This spark ignition system complies with Canadian ICES-002.

Ce système d'allumage par étincelle de véhicule est conforme à la norme NMB-002 du Canada.

Contents

Introduction	3	Daily Maintenance Checklist	21
Safety	3	Lubricate Fittings and Bearings	22
Supervisor's Responsibilities	3	Changing Engine Oil and Filter	23
Before Operating	3	General Precleaner and Air Cleaner Maintenance ..	24
While Operating	4	Clean and Lubricate Foam Precleaner	24
While Dumping	5	Service Air Cleaner Paper Element	24
Maintenance	5	Clean Air Intake/Cooling Areas	25
Safety and Instruction Decals	7	Check Spark Plug Gap and Condition	25
Specifications	9	Changing Hydraulic Oil And Filter	25
General Specifications	9	Checking Hydraulic Lines and Hoses	27
Optional Equipment	10	Fuel Filter Replacement	27
Loose Parts	10	Sweeper Reel Height Adjustment	27
Before Operating	10	Belt Removal/Installation	28
Grass Baffle	10	Clutch Switch Adjustment	28
Check Tire Pressure	10	Electric Brake Clutch Adjustment	28
Check Crankcase Oil	11	Clutch Testing	29
Fill Fuel Tank With Gasoline	11	Adjusting Parking Brake	29
Check Hydraulic System Oil	12	Adjusting Traction Pedal	29
Check Torque of Wheel Nuts	13	Steering Chain Adjustment	30
Know Your Controls	14	Replacing Sweeper Reel Fingers	30
Operation	17	Hopper and Reel Clean Out	30
Checking Interlock System	17	Wheel Motor Axle Nut Torque	30
Operating Characteristics	17	Battery Storage	31
Pushing or Towing Sweeper	18	Battery Care	31
Transporting Sweeper	18	Troubleshooting	32
Sweeper Operation	18	Storage	33
While Sweeping	19	Hydraulic Schematic	33
Dumping the Hopper	19	Electrical Schematic	34
Maintenance	20	The Toro General Commercial Products Warranty ...	36
Recommended Maintenance Schedule	20		

Introduction

Read this manual carefully to learn how to operate and maintain your product properly. The information in this manual can help you and others avoid injury and product damage. Although Toro designs and produces safe products, you are responsible for operating the product properly and safely.

Whenever you need service, genuine Toro parts, or additional information, contact an Authorized Service Dealer or Toro Customer Service and have the model and serial numbers of your product ready. The two numbers are stamped on a plate which is located on the blower housing.

Write the product model and serial numbers in the space below:

Model No. _____
Serial No. _____

This manual identifies potential hazards and has special safety messages that help you and others avoid personal injury and even death. **Danger**, **Warning**, and **Caution** are signal words used to identify the level of hazard. However, regardless of the hazard, be extremely careful.

Danger signals an extreme hazard that *will* cause serious injury or death if you do not follow the recommended precautions.

Warning signals a hazard that *may* cause serious injury or death if you do not follow the recommended precautions.

Caution signals a hazard that may cause minor or moderate injury if you do not follow the recommended precautions.

This manual uses two other words to highlight information. **Important** calls attention to special mechanical information and **Note**: emphasizes general information worthy of special attention.

Safety

Hazard control and accident prevention are dependent upon the awareness, concern, and proper training of the personnel involved in the operation, transport, maintenance, and storage of the machine. Improper use or maintenance of the machine can result in injury or death. To reduce the potential for injury or death, comply with the following safety instructions.

Supervisor's Responsibilities

- Ensure operators are thoroughly trained and familiar with the Operator's Manual and all decals on the machine.
- Establish your own special procedures and work rules for unusual operating conditions (e.g., slopes too steep for machine operation, adverse weather conditions, etc.).

Before Operating

- Read, understand and follow the instructions in the Operator's Manual and on the machine before starting. Become familiar with all controls and know how to stop quickly. A free replacement manual is available by sending complete Model and Serial Number to:
The Toro Company
8111 Lyndale Avenue South
Minneapolis, Minnesota 55420-1196
- NEVER allow children to operate the machine. NEVER allow adults to operate the machine without proper instruction. Only trained operators who have read this manual should operate this machine.
- NEVER operate the machine while under the influence of drugs or alcohol.
- Become familiar with the controls and know how to stop the engine quickly.
- Keep all shields, safety devices, and decals in place. If a shield, safety device, or decal becomes damaged, malfunctioning, or illegible, repair or replace it before operation is commenced. Also tighten loose nuts and bolts to ensure machine is in safe operating condition.
- Always wear substantial shoes. Do not operate machine while wearing sandals, tennis shoes, or sneakers or when barefoot. Do not wear loose-fitting clothing that could get caught in moving parts and possibly cause injury. Wearing safety glasses, safety shoes, long pants, and a helmet is advisable and required by some local ordinances and insurance regulations.
- Do not alter this equipment in any manner which may cause hazardous conditions.

- Safety interlock switches are for the operators protection. Disconnected or malfunctioning safety interlock switches could allow the machine to operate in an unsafe manner and may cause personal injury.
 - Do not disconnect the safety interlock switches.
 - Check the operation of the switches daily to be sure the interlock system is operating correctly.
 - If a switch is malfunctioning, replace it before operating the machine.
- In certain conditions gasoline is extremely flammable and highly explosive. A fire or explosion from gasoline can burn you and others and cause property damage. Caution must be used when storing or handling gasoline.
 - Do not fill fuel tank while engine is running or hot or when machine is in an enclosed area. Vapors may build up and be ignited by a spark or flame source many feet away. **DO NOT SMOKE** while filling the fuel tank to prevent possibility of explosion.
 - Always fill fuel tank outside and wipe up any spilled gasoline before starting engine.
 - Use a funnel or spout to prevent spilling gasoline and fill tank to about 1 inch (25 mm) below the filler neck.
 - Store gasoline in a clean, safety approved container and keep the cap in place on the container.
 - Keep gasoline in a cool, well ventilated place; never in an enclosed area such as a hot storage shed.
 - To assure volatility, do not buy more than a 30 day supply of gasoline.

with terrain angles, ricochets, or missing or damaged guards, can lead to thrown object injuries. Do not resume sweeping until area is cleared.

- NEVER carry passengers.
- ALWAYS look to the rear of machine before backing up and assure no one is behind the machine.
- When starting the engine:
 - Sit on operator's seat and engage parking brake.
 - Make sure traction pedal is in neutral and Reel PTO Engagement handle is in the OFF position (disengaged).
 - After engine is started, release parking brake and keep foot off traction pedal. Machine must not move. If movement is evident, the neutral mechanism is adjusted incorrectly; shut off engine and adjust until machine does not move when traction pedal is released. (Refer to Adjusting Traction Pedal, (page 27.) If engine does not crank, check interlock switch connections.
- Do not touch engine, muffler, or muffler shield while engine is running or soon after it has stopped because these areas may be hot enough to cause a burn.
- Tip over can cause serious injury or death.
 - NEVER operate on steep slopes.
 - Sweep slopes up and down, never across the face.
 - When going uphill or downhill, do not stop or start suddenly.
 - Stay alert for holes in the terrain or other hidden hazards. To avoid tipping or loss of control, do not drive close to a ditch, creek, or drop off.
 - If engine stalls or machine loses headway and cannot make it to the top of a slope, do not turn machine around. Always back slowly straight down the slope.
- Using the machine demands attention. Failure to operate machine safely may result in an accident, tip over of the machine, and possible serious injury or death. Drive carefully. To prevent tipping or loss of control:
 - Operate only in daylight or when there is good artificial light.
 - Drive slowly.
 - Watch for holes or other hazards.
 - Use care when backing machine.
 - Do not drive close to a sand trap, ditch, tall curb, creek, or other hazard.
 - Reduce speed when making sharp turns and when turning on a hillside.

While Operating

- Rotating parts can cause serious personal injury. Keep hands and feet away from sweeper reels while machine is running. Keep hands, feet, hair, and clothing away from all moving parts to prevent injury. NEVER operate the machine with covers, shrouds, or guards removed.
- Do not run the engine in a confined area without adequate ventilation. Exhaust fumes are hazardous and could possibly be deadly.
- Operator should be seated when starting the engine and remain seated whenever the machine is in motion. Operator should keep both hands on steering wheel whenever possible.
- **DON'T TAKE AN INJURY RISK!** When a person or pet appears unexpectedly in or near the sweeping area, **STOP SWEEPING.** Careless operation, combined

- Avoid sudden stops and starts.
- Do not go from reverse to forward or forward to reverse without first coming to a complete stop.
- Do not attempt sharp turns or abrupt maneuvers or other unsafe driving actions that may cause loss of control.
- Watch out for traffic when near or crossing roads. Always yield the right-of-way.
- Operator must be skilled and trained in how to drive on hillsides. Failure to use caution on slopes or hills may cause loss of control, possibly resulting in personal injury or death.
- Before getting off seat:
 - Move traction pedal to neutral position and remove foot from pedal.
 - Set parking brake and set Reel PTO Engagement handle to the OFF position (disengaged).
 - Shut engine off and remove key from ignition switch. Wait for all movement to stop before getting off seat.
- Whenever the machine is left unattended, be sure engine is stopped, Reel PTO Engagement handle is in OFF position (disengaged), and key is removed from ignition.

While Dumping

- Moving hopper door and dumping debris can cause serious injury. Stay clear of hopper while machine is backing up or dumping.
- Keep bystanders a safe distance from hopper when operating to dump debris or when opening and closing hopper door.
- Under rare circumstances wet, compressed grass clippings may generate heat. Always empty the hopper before storing the unit.
- Raising and lowering of hopper door could cause injury to bystanders or pets. Keep bystanders and pets a safe distance from hopper when operating to dump debris or when opening and closing hopper door.
- To avoid the risk of electrical shock, dump hopper only in area clear of overhead wires and other obstructions.
- NEVER dump hopper on a slope. Always dump hopper on level ground.
- Set Reel PTO Engagement handle to OFF (disengaged) before dumping.

Maintenance

- Hydraulic fluid escaping under pressure can penetrate skin and do serious damage. Keep body and hands away from pin hole leaks or nozzles that eject high pressure hydraulic fluid. Use cardboard or paper to find hydraulic leaks. Fluid accidentally injected into the skin must be surgically removed within a few hours by a doctor familiar with this form of injury or gangrene may result.
- Accidental starting of engine by others while maintenance is being performed could cause injury. Before servicing or making adjustments to the machine:
 - Stop engine.
 - Set parking brake.
 - Remove key from ignition switch.
- Unexpected movement of the machine caused by an improperly adjusted traction pedal may cause personal injury. When foot is removed from traction pedal, the machine should stop; it must not move in either direction. If machine does move, do not operate until neutral assembly has been repaired or adjusted.
- Accidental movement of machine due to parking brake not being set may cause personal injury. The hydrostatic transmission will not, at any time, act as a parking brake for the machine. To engage parking brake, pull back on lever. Whenever the engine is shut off, the parking brake must be engaged to prevent accidental movement of the machine.
- Engine must be running so final adjustment of the traction adjustment cam can be performed. To guard against possible personal injury, keep hands, feet, face, and other parts of the body away from the muffler, other hot parts of the engine, and other rotating parts.
- Perform only those maintenance instructions described in this manual. If major repairs are ever needed or assistance desired, contact an Authorized TORO Distributor.
- Failure to maintain proper torque could result in failure or loss of wheel and may result in personal injury.
 - Torque wheel motor axle nuts to 200–400 ft.–lb.
 - Torque rear wheel lug nuts to 45–55 ft.–lb.
- To reduce potential fire hazard, keep the engine free of excessive grease, grass, leaves, and accumulations of dirt.
- Make sure all hydraulic line connectors are tight, and all hydraulic hoses and lines are in good condition before applying pressure to the system.

- Performing maintenance on machine not properly supported with jack stands may cause machine to fall and could cause injury.
- Do not over speed the engine by changing the governor settings. Maximum engine rpm with no load is 3000 rpm. To ensure safety and accuracy, have an Authorized TORO Distributor check maximum engine speed with a tachometer.
- Engine must be shut off before checking oil or adding oil to the crankcase.
- If wheel is removed for maintenance or repairs on the wheel, brake, or hydraulic wheel motor, when remounting wheel ALWAYS ensure that the wheel motor axle nut is torqued to 200–400 ft.–lb.
- To be sure of optimum performance and safety, always purchase genuine TORO replacement parts and accessories. Replacement parts and accessories made by other manufacturers could be dangerous. Altering this machine in any manner may affect the machine's operation, performance, or durability, or its use may result in injury or death. Such use could void product warranty of The Toro Company.
- NEVER attempt to service the gas springs located on hopper and hopper door. These springs are under high loads and improper handling can result in bodily harm. Special tools are required to replace worn or damaged gas springs; contact an Authorized TORO Distributor.

Safety and Instruction Decals



Safety decals and instructions are easily visible to the operator and are located near any area of potential danger. Replace any decal that is damaged or lost.



87-6020



67-5360



53-4420

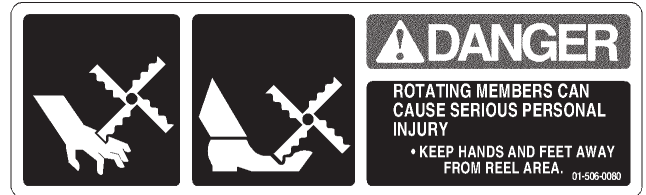

01-506-0080



27-7310



85-7490

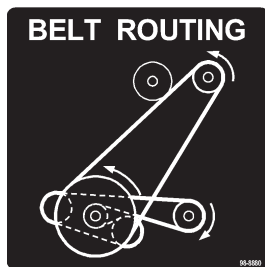

98-8880

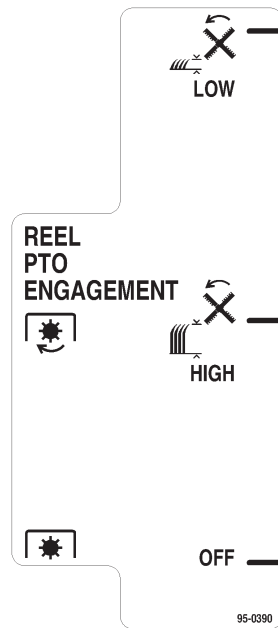

95-0390



80-9350

⚠ DANGER
USE EXTREME CAUTION ON HILLS AND SLOPES

TIP OVER CAN CAUSE SERIOUS INJURY OR DEATH

- NEVER OPERATE ON STEEP SLOPES.
- NEVER ATTEMPT TO DUMP THE HOPPER ON A SLOPE. ALWAYS DUMP THE HOPPER ON LEVEL GROUND.
- SWEEP SLOPES UP AND DOWN, NEVER ACROSS THE FACE.
- WHEN GOING UPHILL OR DOWNHILL, DO NOT STOP OR START SUDDENLY.
- GO SLOW AND AVOID SHARP TURNS.
- STAY ALERT FOR HOLES IN THE TERRAIN OR OTHER HIDDEN HAZARDS. TO AVOID TIPPING OR LOSS OF CONTROL, DO NOT DRIVE CLOSE TO A DITCH, CREEK, OR DROP OFF.
- IF MACHINE STOPS GOING UP HILL, DISENGAGE REELS OR BRUSHES AND BACK SLOWLY DOWN HILL. DO NOT ATTEMPT TO TURN.
- OPERATOR MUST BE SKILLED AND TRAINED IN SLOPE OPERATION - READ OPERATOR'S MANUAL.

01-506-0090

01-506-0090



95-0370

1. Fast
2. Continuous variable setting
3. Slow

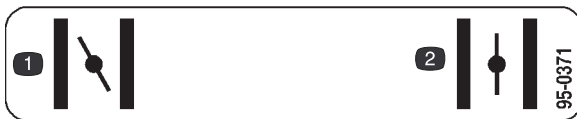

95-0371

1. Choke—on
2. Choke—off

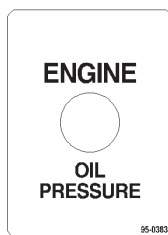

95-0383

STARTING INSTRUCTIONS:

1. REEL PTO MUST BE OFF AND TRACTION PEDAL IN NEUTRAL POSITION TO ENABLE ENGINE STARTER CIRCUIT.
2. APPLY PARKING BRAKE TO AVOID UNINTENTIONAL MOVEMENT OF MACHINE.
3. REFER TO OPERATOR'S MANUAL FOR DETAILED STARTING INSTRUCTIONS.

95-0389

95-0389

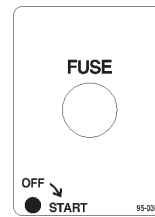

95-0384

⚠ DANGER

ESTA MAQUINA PUEDE SER RIESGOSA SI SE USA EN UNA MANERA INAPROPIADA. OPERADORES DEBEN ESTAR MUY BIEN ENTRENADOS EN LA MANERA APROPIADA DE OPERAR LA MAQUINA.

TO MINIMIZE THE RISK OF PERSONAL INJURY OR DEATH:

- READ AND UNDERSTAND OPERATOR'S MANUAL BEFORE OPERATING THIS MACHINE.
- KEEP HANDS AND FEET AWAY FROM SWEEPER REELS WHILE MACHINE IS RUNNING.
- DO NOT OPERATE WITHOUT BELT AND PULLEY GUARDS IN PLACE.
- STOP ENGINE BEFORE LEAVING OPERATOR'S POSITION. DO NOT OPERATE HOPPER CONTROLS WHILE STANDING BESIDE MACHINE.
- KEEP BYSTANDERS A SAFE DISTANCE FROM HOPPER WHEN OPERATING TO DUMP DEBRIS OR OPEN AND CLOSE HOPPER DOOR. USE CARE WHEN BACKING MACHINE.
- DUMP HOPPER ONLY IN AREA CLEAR OF OVERHEAD WIRES & OTHER OBSTRUCTIONS.
- NEVER DUMP HOPPER ON A SLOPE. ALWAYS DUMP HOPPER ON LEVEL GROUND.
- DO NOT OPERATE UNIT WITHOUT BEING IN THE SEAT. UNIT WILL NOT CONTINUE RUNNING WHEN REEL PTO IS ENGAGED OR TRACTION PEDAL IS ACTIVATED, UNLESS OPERATOR IS IN THE SEAT.
- USE AN OSHA-APPROVED LOCK-OUT TAG WHEN WORKING ON MAINTENANCE OR CLEARING OF DEBRIS LODGED IN SWEEPING REELS.

REPLACEMENT MANUAL AVAILABLE BY SENDING COMPLETE MODEL NUMBER TO: THE TORO COMPANY, 8111 LYNDAL AVE. S., BLOOMINGTON, MN 55420-1196.

95-0387

95-0387

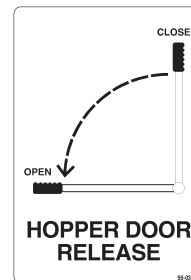

95-0388



88-8950

Specifications

General Specifications

Type	Three wheeled, front steer, rear drive, one person ride–on turf sweeper with welded steel frame and integral hopper for collecting debris.
Engine	Manufacturer: Kohler, Model CH1 BS, air cooled, 4 cycle Horsepower: 18 @ 3600 RPM Maximum Torque: 30 ft.–lb. @ 2500 RPM Compression Ratio: 8.5 : 1 Displacement: 38.1 cu. in. (624 CC) Oil Capacity w/filter: 2.1 quarts (2 liters) Governor: Mechanical Governor Limit: 3000 RPM Idle Speed: 1200 RPM Air Cleaner–High density paper element with oiled foam precleaner Fuel Filter: 15 micron in–line filter
Battery	12 volt with 370 cold cranking amps. (CCA) at 0° F. Type 24.
Fuel System	5 gallon (18.9 liter) tank.
Electrical	Type 24. 12 volt with 370 Cold Cranking Amps (CCA) at 0° F. Electrical circuit is fused at 10.0 Amps.
Traction System	Sundstrand Series 15 pump coupled to Parker/Ross Model MS 10 wheel motors. Filtration – 25 micron suction line filter (replaceable spin on element). Foot pedal control with cable to ramped neutraling device on hydrostatic pump with eccentric neutral adjust.
Controls	Throttle, choke, Reel PTO Engagement handle, parking brake, hopper release handle, and ignition switch are all hand–operated. Forward/reverse traction pedal is foot operated.
Gauges	Hour meter, hydraulic vacuum gauge, and engine oil pressure warning light.
Reel Drive	Electric clutch with brake. Automatically engages when Reel PTO Engagement Handle lowers reels (2 heights). Sweeping pick–up with two counter–rotating finger reels, baffles and skirts. Reels rotate at 1100 RPM, and effectively pick up light debris on turf up to 5 mph.
Steering	Manual, 14 in. soft touch, 3 position tilt steering wheel, 6 to 1 ratio.
Brakes	Rear 6 in. drums with hand lever actuated to dual cables.
Tires, Wheels	Front (1)–18 x 8.5–8 in. turf tread. Rear (2)–18 x 9.5–8 in. ribbed tread. All tires 4 ply rating, tubeless type.
Seat	High–back cushion with slide adjust.
Interlock Switches	Prevents engine starting if traction pedal or Reel PTO Engagement handle are engaged. Stops engine if operator leaves seat with either traction pedal or PTO switch engaged.
Hopper	Stationary, 1.25 cu. yd. capacity, with deflectors and grass filling baffles. Gas strut supported rear dumping door, with integral discharge duct and wire mesh screen for directing dust and air away from operator.

General Specifications (continued)

General Specifications (approx.)	Weight: 1600 lb. Payload/Operator: 740 lb. Ground Speed: 6.5 mph. Width Overall: 70.0 in. Height Overall: 67.0 in. Height Overall: (with optional ROPS): 86.0 in. Length Overall: 111.0 in. Curb Clearance: 4 in.
-------------------------------------	--

Note: Specifications and design subject to change without notice.

Optional Equipment

ROPS/Seat Belt Package	Available from Authorized TORO Distributor
Spark Arrestor	Kohler Part No. 25-189-02

Loose Parts

Note: Use this chart as a checklist to ensure that all parts have been received. Without these parts, total setup cannot be completed.

Description	Qty.	Use
Operator's Manual	1	Read before operating the machine.
Kohler Engine Owners Manual	1	Read before operating the machine.
Parts Catalog	1	

Before Operating

Grass Baffle

The sweeper comes with a hopper baffle extension installed. This extension greatly enhances the filling capacity of the hopper. You may find that the particular debris that you are sweeping tends to fall back into the hopper inlet and clogs the reels. When this occurs removal of the extension should alleviate hopper clogging. If you are sweeping fine dry material such as thatch or grass clippings, the baffle extension should be used. When sweeping larger debris such as oak leaves, you may prefer to remove the extension.

- To remove the hopper baffle extension, remove the (5) bolts. Store the fasteners and the extension in a safe location.

Check Tire Pressure

Check tire pressure every eight hours or daily to assure proper levels.

- With lower air pressure, turf compaction and tire marks are minimized. Optimum pressure is 10–15 psi on front and rear tires. Lower pressure should not be used for heavy payloads or tire damage may result. Do not exceed the maximum pressure. Maximum air pressure in front tire is 22 psi and rear tires is 24 psi.

Important When replacing tires, use only replacements approved for the Turf Sweeper. Use of tires not approved may cause turf damage.

Check Crankcase Oil

The engine is shipped with oil in the crankcase; however, the oil level must be checked before and after the engine is first started.

Crankcase capacity is approximately 2.1 qt. (2 l) with the filter.

Use high-quality engine oil that meets the following specifications:

API Classification Level Required: SJ, SK, SL, or higher.

Preferred oil: SAE 10W–30 (above 0° F)

Alternate oil: SAE 5W–30 (below 32° F)

Toro Premium Engine oil is available from your distributor in 10W–30 viscosity. See the parts catalog for part numbers.

1. Position the sweeper on a level surface and make sure engine is off.
2. Remove the dipstick and wipe it with a clean rag. Push dipstick down into the tube and ensure it is fully seated. Pull dipstick out of the tube and check level of oil.



Figure 1

1. Dipstick

2. Filler cap

3. Install dipstick into tube.
4. If oil is low, use a clean rag to clean area around oil fill cap. Remove cap and add oil until level is up to, but not over, the **F** mark on the dipstick. Add the oil slowly and check the level often during this process.

Important Be sure to keep the engine oil level between the upper and lower limits on the oil gauge. Engine failure may occur as a result of over filling or under filling the engine oil.

Important Check oil after each day's operation or each time machine is used. Change oil and filter after the first 50 hours of operation. Thereafter change oil and filter every 100 hours or operation.

Fill Fuel Tank With Gasoline



Danger



IN CERTAIN CONDITIONS GASOLINE IS EXTREMELY FLAMMABLE AND HIGHLY EXPLOSIVE. A FIRE OR EXPLOSION FROM GASOLINE CAN BURN YOU AND OTHERS AND CAUSE PROPERTY DAMAGE.

- Caution must be used when storing or handling gasoline.
- Do not fill fuel tank while engine is running or hot or when machine is in an enclosed area. Vapors may build up and be ignited by a spark or flame source many feet away.
- To prevent the possibility of explosion, **DO NOT SMOKE** while filling the fuel tank.
- Always fill fuel tank outside and wipe up any spilled gasoline before starting engine.
- Use a funnel or spout to prevent spilling gasoline before starting engine. Fill tank to about 1 inch (25 mm) below the filler neck.
- Store gasoline in a clean, safety approved container and keep the cap in place on the container.
- Keep gasoline in a cool, well ventilated place, never in an enclosed area such as a hot storage shed.
- To assure volatility, do not buy more than a 30-day supply of gasoline.
- Gasoline is a fuel for internal combustion engines; therefore, do not use it for any other purpose. Since many children like the smell of gas, keep it out of their reach because the fumes are explosive and dangerous to inhale.

Fuel Type – For best results use only clean, fresh, UNLEADED gasoline with a pump sticker octane rating of 87 or higher. In countries using the Research method, it should be 90 octane minimum.

THE TORO COMPANY STRONGLY RECOMMENDS THE USE OF FRESH, CLEAN, UNLEADED REGULAR GRADE GASOLINE IN TORO GASOLINE-POWERED PRODUCTS. UNLEADED GASOLINE BURNS CLEANER, EXTENDS LIFE, AND PROMOTES GOOD STARTING BY REDUCING THE BUILD-UP OF COMBUSTION CHAMBER DEPOSITS.

Note: Gasoline/Alcohol Blends – Gasohol (up to 10% ethyl alcohol, 90% unleaded gasoline by volume) may be used. Do not use other gasoline/alcohol blends.

Note: Gasoline/Ether Blends–Methyl Tertiary Butyl Ether (MTBE) and unleaded gasoline blends (up to a maximum of 15% MTSE by volume) may be used. Do not use other gasoline/ether blends.

1. Use a clean rag to clean area around fuel tank cap.
2. Remove the cap from the fuel tank and fill the 5 gallon tank to within 1 inch (25 mm) from the top with unleaded gasoline. Install fuel cap tightly.



Figure 2

1. Fuel tank cap

3. Wipe up any gasoline that may have spilled to prevent a fire hazard.

Check Hydraulic System Oil

! **Danger** !

HYDRAULIC FLUID ESCAPING UNDER PRESSURE CAN PENETRATE SKIN AND DO SERIOUS DAMAGE.

- **Keep body and hands away from pin hole leaks or nozzles that eject high pressure hydraulic fluid. Use cardboard or paper to find hydraulic leaks. Fluid accidentally injected into the skin must be surgically removed within a few hours by a doctor familiar with this form of injury or gangrene may result.**

Check level of hydraulic fluid before engine is first started and daily thereafter. The hydraulic system is designed to operate on Mobil DTE 13M or equivalent ISO VG 32 Wide-temperature, shear-stable hydraulic fluid with controlled low-temperature flow properties and anti-wear protection. The reservoir is filled at the factory with approximately 28 quarts of Mobil DTE 13M hydraulic fluid. Hydraulic oil viscosity (weight) must be selected according to average anticipated ambient temperature. Temperature/viscosity recommendations are as follows:

Expected Ambient Temperatures		
Recommended Oil	Start-Up	Average Daily Temperature
Mobil DTE 13M or equivalent ISO VG 32	Less than 40° F–50° F (4.5° C–10° C)	Less than 80° F (26.7° C)
Mobil DTE 26 or equivalent ISO VG 68	Greater than 60° F–70° F (15.5° C–21° C)	Greater than 80° F (26.7° C)

Important Using Mobil DTE 26 or equivalent ISO VG 68 hydraulic oil when temperature at start-up is less than 40° F (4.5° C) could cause serious hydraulic system damage.

1. Position the sweeper on a level surface and make sure engine is off.
2. Remove dipstick cap (located under operators seat) from filler neck and wipe it with a clean rag. Insert dipstick cap onto filler neck; then remove it and check level of oil. If level is below the L mark on dipstick, add sufficient hydraulic fluid to bring to the F mark. DO NOT OVERFILL.

Important To prevent system contamination, clean top of hydraulic oil containers before opening. Assure pour spout and funnel are clean. When adding oil to the hydraulic system, use a funnel with a fine screen—200 mesh—and ensure funnel and oil are clean. This procedure prevents accidental contamination of the hydraulic oil which will damage the hydraulic system.

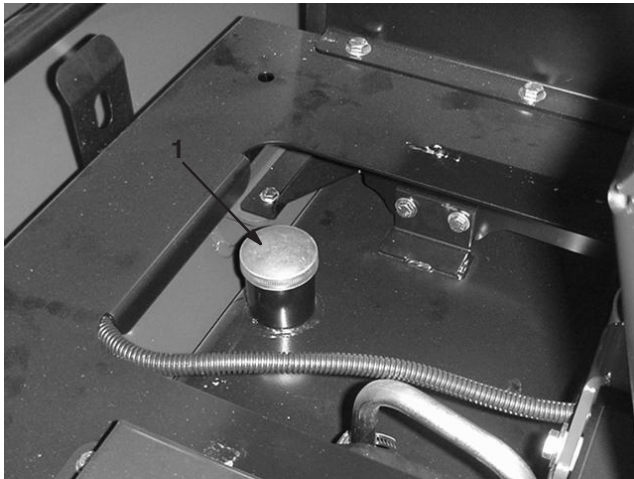

Figure 3

1. Dipstick cap

Check Torque of Wheel Nuts



Warning



Failure to maintain proper torque could result in failure or loss of wheel and could result in personal injury. Torque rear wheel lug nuts to 45–55 ft. lb.



Figure 4

1. Lug nut

Know Your Controls

Choke (Fig. 5)–To start a cold engine, move the choke control forward to close the choke. After engine starts, regulate choke to keep engine running smoothly. As soon as possible, move the choke backward to open the choke. A warm engine requires little or no choking.

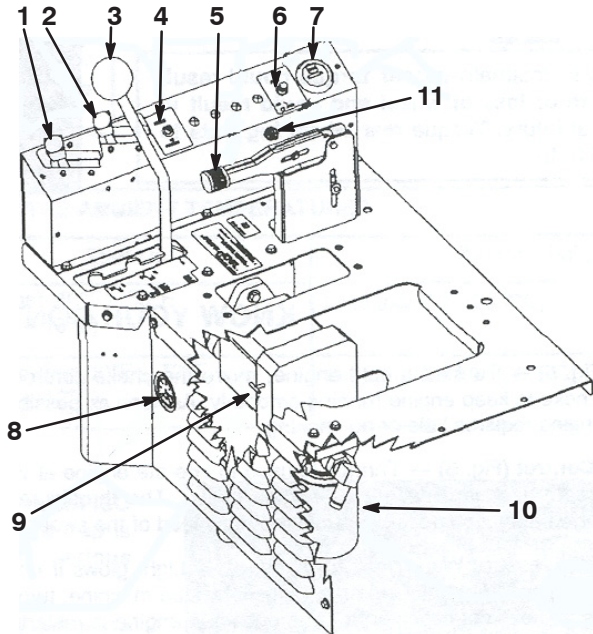

Figure 5

- | | |
|--------------------------------------|---------------------------|
| 1. Throttle control | 6. Fuse |
| 2. Choke | 7. Hour meter |
| 3. Reel PTO engagement handle | 8. Hydraulic vacuum gauge |
| 4. Engine oil pressure warning light | 9. Tow valve knob |
| 5. Parking brake | 10. Hydraulic oil filter |
| | 11. Ignition key switch |

Throttle Control (Fig. 5)–Throttle is used to operate engine at various speeds. Moving throttle forward increases engine speed; backward decreases engine speed. The throttle regulates the speed of the sweeper reels and, in conjunction with traction pedal, controls ground speed of the sweeper.

Engine Oil Pressure Warning Light (Fig. 5)–Light glows if engine oil pressure drops below a safe level while engine is running. It light flickers or remains ON, stop machine, turn off engine, and check oil level. If oil level is low, but

adding oil does not cause light to go out when engine is restarted, turn off engine immediately and contact your local Authorized TORO Distributor for assistance.

Ignition Key Switch (Fig. 5) – The key switch, which is used to start and stop the engine, has three positions: OFF, RUN, and START. Rotate key clockwise (START) to engage starter motor. When engine starts, release key and it will move automatically to the RUN position. To shut engine off, rotate key counterclockwise to the OFF position.

Fuse: (Fig. 5) – Provides 10 amps ignition circuit protection. If fuse is blown the engine will not crank.

Hour Meter (Fig. 5) – Indicates total hours of machine operation. The hour meter starts to function whenever the key switch is rotated to the ON position.

Reel PTO Engagement Handle (Fig. 5) – The engagement of the sweeper reels is done with the Reel PTO Engagement handle. The handle also sets the height of the fingers. There are two settings for finger height. The height of the fingers is initially set so the fingers touch the top of the turf. The first setting will set the fingers at 1–1/4 inch from the surface. The second setting sets the fingers at 5/8 inch from the surface.

Hydraulic Vacuum Gauge (Fig. 5) – When the hydraulic oil filter becomes dirty, the vacuum level within the hydraulic system will increase. Check vacuum gauge after each day's operation and before shutting off engine. (Refer to Changing Hydraulic Oil and Filter)

Tow Valve Knob (Fig. 5) – The tow valve knob is located in the front of the hydraulic pump. With the knob turned fully clockwise the machine is in the operating position. With the knob turned 1/2 turn counterclockwise the machine is in towing position. After completion of mowing operation, and before starting engine, close tow valve securely by rotating fully clockwise. Do not exceed 5–8 ft.–lb. torque.

Parking Brake (Fig. 5)–Whenever the engine is shut off, the parking brake must be engaged to prevent accidental movement of the machine. To engage the parking brake, pull back on lever. To release the parking brake push forward on lever. Make sure parking brake is released before moving machine. If the machine is parked on a grade, make sure parking brake is applied.

Tilt Steering Lever (Fig. 6) – Lever on left side of steering tower. Lift lever to adjust steering wheel to desired fore or aft operating position and release lever to lock in place.

Seat Adjusting Lever (Fig. 6) – To adjust fore and aft position of seat, move lever on left side of seat outward, slide seat to desired position, and release lever so it will lock in position.

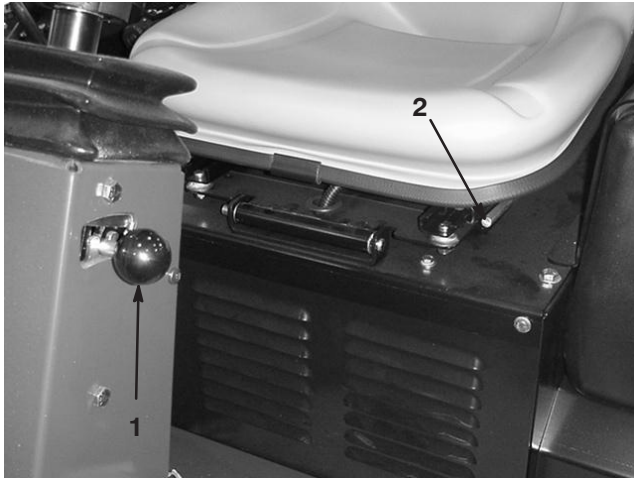

Figure 6

- 1. Tilt steering lever
- 2. Seat adjusting lever

Seat Prop (Fig. 7) – To lock seat in tilted forward position, rotate the seat prop up until positive stop.

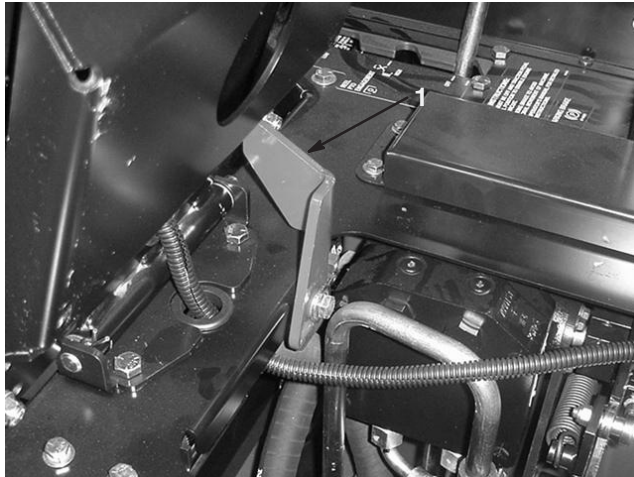

Figure 7

- 1. Seat prop

⚠

Caution

⚠

UNEXPECTED MOVEMENT OF THE MACHINE CAUSED BY AN IMPROPERLY ADJUSTED TRACTION PEDAL MAY CAUSE PERSONAL INJURY.

- When foot is removed from traction pedal, the machine should stop; it must not move in either direction. If machine does move, do not operate until neutral assembly has been repaired or adjusted; refer to Adjusting Traction Pedal.**

Traction Pedal (Fig. 8) – The traction pedal is foot operated and is used to make the machine move forward and backward and to stop the machine. Using the heel and toe of the right foot, depress top of pedal to move forward and bottom of pedal to move rearward, To stop machine remove foot from pedal. Ground speed is proportionate to how far pedal is depressed, For maximum ground speed with no load, traction pedal must be fully depressed while throttle is in full position. Allowing pedal to move to neutral position will stop machine.

Maximum forward speed is approximately 6.5 mph (10.5 Km/hr). Maximum forward speed while sweeping is 5 mph. To get maximum power under heavy load or when ascending a hill, have throttle in full position while depressing traction pedal slightly to keep engine rpm high. When engine rpm begins to decrease, release traction pedal slightly to allow rpm to increase. When sweeping wet debris or a thick layer of material, slower speeds may need to be used.



Figure 8

- 1. Traction pedal

Caution

ACCIDENTAL MOVEMENT OF MACHINE DUE TO PARKING BRAKE NOT BEING SET MAY CAUSE PERSONAL INJURY.

- The hydrostatic transmission will not, at any time, act as a parking brake for the machine. To engage parking brake, pull back on lever.
- Whenever the engine is shut off, the parking brake must be engaged to prevent accidental movement of the machine.

Hopper Door Release Handle (Fig. 9) – The hopper is dumped manually with the hopper door release handle.



Figure 9

1. Hopper door release handle

Hopper Door Locking Knob (Fig. 10) Locks hopper door in the raised position.

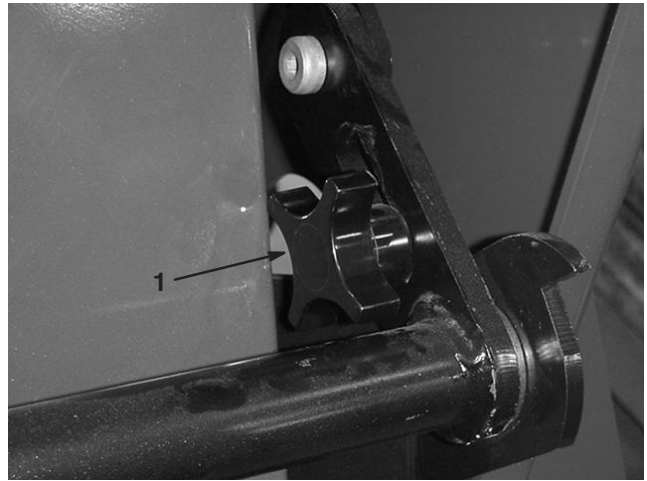

Figure 10

1. Hopper door locking knob



Seat Locking Spring Flap (Fig. 11) Locks seat in lowered position.



Figure 11

1. Seat Locking Spring Flap

Operation

Warning

ROTATING PARTS CAN CAUSE SERIOUS PERSONAL INJURY

- **Keep hands and feet away from sweeper reels while machine is running.**
- **Keep hands, feet, hair, and clothing away from all moving parts to prevent injury.**
- **NEVER operate the machine with covers, shrouds, or guards removed.**

1. Place the unit on a level surface and apply the parking brake.
2. Remove foot from traction pedal and make sure pedal is in neutral position.
3. With the throttle 1/2 open and the choke closed, insert key into ignition switch and rotate it clockwise to start engine. Release key when engine starts and open the choke gradually.

Note: Do not run starter motor more than 10 seconds at a time or premature starter failure may result. If engine fails to start after 10 seconds, turn key to OFF position, recheck controls and procedure. wait 60 seconds and repeat starter operation.



4. When engine is started for the first time, after engine oil change, hydraulic oil change or hydraulic service work, operate the machine in forward and reverse for one to two minutes. Also operate the Reel PTO Engagement and Hopper Door Release to verify proper operation of all parts.
5. Turn steering wheel to the left and right to check steering response. Shut off engine and check fluid levels. Check for oil leaks, loose parts and any noticeable malfunctions.

Checking Interlock System

The purpose of the safety interlock system is to prevent the engine from cranking or starting unless the traction pedal is in neutral and the Reel PTO Engagement handle is in the OFF (disengaged) position. In addition, the engine will stop when the Reel PTO is engaged or the traction pedal is depressed with the operator off the seat. Indications of a disconnected or malfunctioning interlock switch are:

- A. A disconnected or malfunctioning safety interlock switch could allow the engine to be started when the traction pedal is not in the neutral position or the Reel PTO Engagement handle is in the HIGH or LOW (engaged) position.

- B. A disconnected or malfunctioning safety interlock switch could allow the engine to continue running when the Reel PTO Engagement handle is in the HIGH or LOW (engaged) position or the traction pedal is depressed with the operator off the seat.

Caution

SAFETY INTERLOCK SWITCHES ARE FOR THE OPERATOR'S PROTECTION. DISCONNECTED OR MALFUNCTIONING SAFETY INTERLOCK SWITCHES COULD ALLOW THE MACHINE TO OPERATE IN AN UNSAFE MANNER AND MAY CAUSE PERSONAL INJURY.

- **Do not disconnect the safety interlock switches.**
- **Check operation of the switches daily to be sure the interlock system is operating correctly.**
- **If a switch is malfunctioning, replace it before operating the machine.**

1. Sit on operator's seat and engage parking brake.
2. Move the Reel PTO Engagement handle to the OFF position and remove foot from traction pedal (neutral position).
3. Rotate the ignition key to START. Engine should crank. If engine cranks, proceed to step 4. If engine fails to crank, there may be a malfunction in the interlock system.
4. Raise off the seat and position the Reel PTO engagement handle to either the HIGH or LOW position while the engine is running. The engine should stop within 2 seconds. If the engine stops, the switch is operating correctly; proceed to step 5. If the engine does not stop, there is a malfunction in the interlock system.
5. Raise off the seat and depress the traction pedal while the engine is running and the Reel PTO is disengaged. The engine should stop within 2 seconds. If the engine stops, the switch is operating correctly; continue operation. If the engine does not stop, there is a malfunction in the interlock system.

Operating Characteristics

Practice driving the TURF SWEEPER 4800 before initial operation because the hydrostatic transmission and its characteristics are different than some turf maintenance machines. Some points to consider when operating the sweeper are the engine speed, transmission speed, and the load on the sweeper reels.

The engine provides power to both the hydrostatic transmission and the sweeper reels. An increasing load on the hydrostatic transmission, such as hill climbing or a full hopper, will result in less power available to the sweeper

reels, thereby decreasing the efficiency of debris pickup. To maintain enough power for the sweeper reels while operating, regulate traction pedal to keep engine speed high and somewhat constant. This allows the engine to provide sufficient power to the sweeper reels while maintaining a satisfactory ground speed. By contrast, pushing down too far on the traction pedal will increase load on the engine and decrease the power available to the sweeper reels.

A good rule to follow is: decrease ground speed as the load on the sweeper reels increases; and increase ground speed as load on the sweeper reels decreases. This allows the engine, working with the transmission, to maintain the proper ground speed while maintaining a high sweeper reel speed necessary for efficient pickup. Allow traction pedal to move upward as engine speed decreases, and depress pedal slowly as speed increases. By comparison, when driving from one work area to another – with no load and sweeper reel disengaged – have throttle in the full position and depress traction pedal slowly but fully to attain maximum ground speed. Sweeping, in some instances, can be improved by slower ground speed.

Before stopping the engine, disengage all controls and move the throttle to the slow position. Moving the throttle to the slow position reduces high engine speed, noise and vibration. Allow the engine to idle for a few seconds then turn ignition key OFF to stop engine.

Pushing or Towing Sweeper

In case of an emergency, the sweeper can be pushed or towed for a short distance. However, TORO does not recommend this as standard procedure.

Important Do not push or tow the sweeper faster than 2 – 3 mph because the drive system may be damaged. If sweeper must be moved a considerable distance, transport it on a truck or trailer.

1. Locate the tow valve knob in the front of the hydraulic pump.
2. Rotate tow valve knob 1/2 turn counterclockwise.
3. After completion of towing operation, and before starting engine, close tow valve securely by rotating it fully clockwise. Do not exceed 5 – 8 ft. lb. torque.

Transporting Sweeper

When transporting the sweeper use only the tie-downs welded into the frame of machine to secure it to a trailer. Use of hopper linkages, steering wheels, or anything other than the proper tie-down locations could cause damage to the machine.

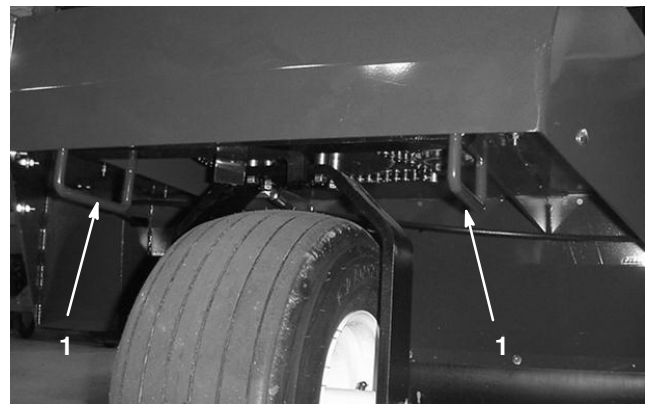

Figure 12

1. Front tie-down

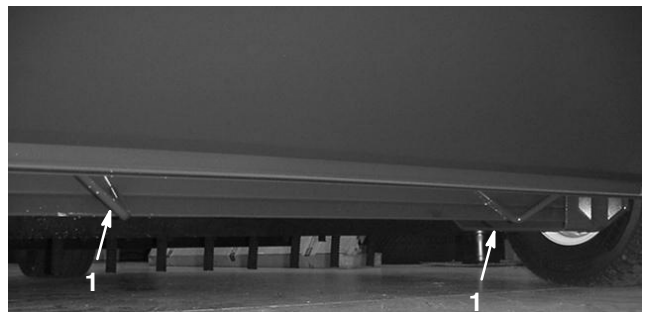

Figure 13



1. Rear tie-down

Sweeper Operation

1. Release the parking brake.
2. With the throttle 1/2 open and the choke closed, insert key into ignition switch and rotate it clockwise to start engine. Release key when engine starts and open choke gradually.
3. Using the toe of your foot, press the traction pedal forward to move forward. Using the heel of your foot, press down on the traction pedal to move backward. Practice moving both ways to get a feel of the machine. For quick braking, when going forward, depress the heel of the traction pedal until hydrostatic transmission reaches neutral. For emergency braking, completely remove foot from the traction pedal.
4. Run engine to full throttle.
5. As you are moving forward, engage the Reel PTO Engagement handle to engage the finger reels.

Important NEVER run the reels in one place for any amount of time because the turf will be damaged.

While Sweeping



 **Danger** 

TIP OVER CAN CAUSE SERIOUS INJURY OR DEATH.

- NEVER operate on steep slopes.
- Sweep slopes up and down, never across the face.
- When going uphill or downhill, do not stop or start suddenly.
- Stay alert for holes in the terrain or other hidden hazards. To avoid tipping or loss of control, do not drive close to a ditch, creek or drop off.
- If machine stops going uphill, disengage reels and back slowly downhill. Do not attempt to turn.

1. When the hopper is full, disengage reels and transport to dumping area. When the hopper is full the sweeper will no longer pickup as efficiently, leaving or throwing material back on the ground.



Dumping the Hopper

 **Danger** 

TIP OVER/ELECTRICAL SHOCK COULD CAUSE SERIOUS INJURY OR DEATH.

- NEVER dump hopper on a slope. Always dump hopper on level ground.
- Dump only in area clear of overhead wires and other obstructions.

1. Place the machine on a level surface and in position to dump.

 **Caution** 

RAISING AND LOWERING OF HOPPER DOOR COULD CAUSE INJURY TO BYSTANDERS OR PETS.

- Keep bystanders and pets a safe distance from hopper when opening and closing hopper door.

2. Pull the hopper door release handle forward to dump the hopper.
3. Move machine forward to separate dumped material from hopper.

Important Debris caught between hopper and hopper door could cause damage to the machine. Make sure that debris is removed from area where hopper and hopper door meet before closing hopper door.

4. When hopper is empty, return the hopper door to the closed position.

Maintenance

Recommended Maintenance Schedule

Maintenance Service Interval	Maintenance Procedure
After first 50 hours	<ul style="list-style-type: none"> • Change engine oil and filter.
After first 10 hours	<ul style="list-style-type: none"> • Check reel drive belts. • Torque wheel lug nuts.
Every 25 hours	<ul style="list-style-type: none"> • Clean and lubricate foam pre-cleaner. • Clean reel drive area. • Check reel drive belts.
Every 50 hours	<ul style="list-style-type: none"> • Check battery fluid level. • Lubricate gate pivots. • Lubricate all grease fittings. • Check battery cable connections.
Every 100 hours	<ul style="list-style-type: none"> • Replace air filter. • Clean air intake/cooling areas. • Check reel fingers. • Replace fuel filter. • Inspect condition of tires. • Adjust steering chain.
Every 200 hours	<ul style="list-style-type: none"> • Torque wheel lug nuts. • Service spark plugs. • Check electric brake clutch air gap. • Check engine RPM (idle and full throttle).
Every 600 hours or annually, whichever occurs first	<ul style="list-style-type: none"> • Drain and flush fuel tank. • Inspect hopper and gate for damage. • Replace hydraulic fluid and filter.

Daily Maintenance Checklist

Duplicate this page for routine use.

Maintenance Check Item	For the week of:						
	Mon.	Tues.	Wed.	Thurs.	Fri.	Sat.	Sun.
Check safety interlock operation.							
Check parking brake operation.							
Check engine oil level.							
Check hydraulic fluid level.							
Check air filter precleaner.							
Check engine cooling fins.							
Check for unusual engine noises.							
Check for unusual operating noises.							
Check tire pressure.							
Check hydraulic hoses for damage.							
Check for fluid leaks.							
Check instrument operation.							
Check hopper screen.							
Clean wrapped material from reels.							
Check traction pedal operation.							
Check rubber fingers. ¹							
Check steering chain adjustment.							
Lubricate all grease fittings. ²							
Touch up damaged paint.							

¹Replace if missing or broken

²Immediately after **every** washing, regardless of the interval listed

Notation for Areas of Concern

Inspection performed by:		
Item	Date	Information
1		
2		
3		
4		
5		
6		
7		
8		
9		

Lubricate Fittings and Bearings

The sweeper has four self-sealing bearings and two grease fittings that must be lubricated regularly with No. 2 General Purpose Lithium Base Grease. If the machine is operated under normal conditions, lubricate all bearings and bushings after every 50 hours of operation or immediately after every washing. Bearings and bushings must be lubricated daily when operating conditions are extremely dusty and dirty. Dusty and dirty operating conditions could cause dirt to get into the bearings and bushings, resulting in accelerated wear.

1. Lubricate grease fittings:
 - A. Hydraulic pump neutral device (Fig. 14).
 - B. Front wheel bearing hub (Fig. 15).
2. Lubricate the four self-sealing bearings mounted on the sweeper reels with a No. 2 Lithium based grease (Fig. 16 & 17).
3. Lubricate the 14 gate pivot bearings (7 on each side of hopper) with lightweight general purpose lubricating oil.

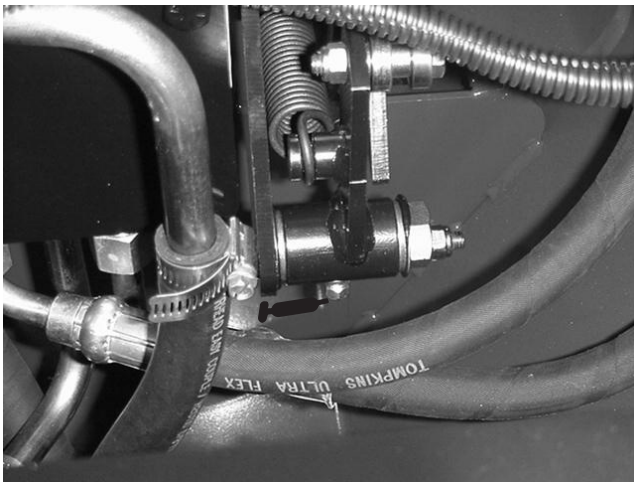

Figure 14



Figure 15



Figure 16



Figure 17

Changing Engine Oil and Filter

Important This product contains an exhaust emission certified engine. Always refer to the engine manufacturer's owner's manual for maintenance and service requirements concerning the emission control system.

Note: For further information on engine operation, maintenance, and repair of engine, refer to engine manufacturer's owner's manual. In some cases TORO may recommend more frequent maintenance intervals than the engine manufacturer. This is due to the extremely dirty and dusty conditions that turf sweepers operate in.

Warning

ACCIDENTAL STARTING OF ENGINE BY OTHERS WHILE MAINTENANCE IS BEING PERFORMED MAY CAUSE PERSONAL INJURY.

- Before servicing or making adjustments to the machine:
- Stop engine.
- Set parking brake.
- Remove key from ignition switch.

Check oil after each day's operation or each time machine is used. Change oil and filter after the first 50 hours of operation. Thereafter change oil and filter every 100 hours or operation. It possible, run engine just before changing oil. Warm oil flows better and carries away more impurities than cold oil.

1. Position machine on a level surface with engine off, parking brake set, and key removed from ignition switch.
2. To keep debris out of engine, clean the area around the oil fill cap/dipstick and oil filter before removing.
3. Remove oil drain plug, oil fill cap, and dipstick. Be sure to allow ample time for complete drainage.
4. Reinstall drain plug.
5. Remove the old filter. Wipe off surface where oil filter mounts. Allow oil filter to drain.
6. Apply a thin coating of new oil to the rubber gasket on replacement oil filter.
7. Install the replacement oil filter to the filter adapter. Turn the oil filter clockwise until rubber gasket contacts the filter adapter, then tighten the filter an additional 1/2 turn.

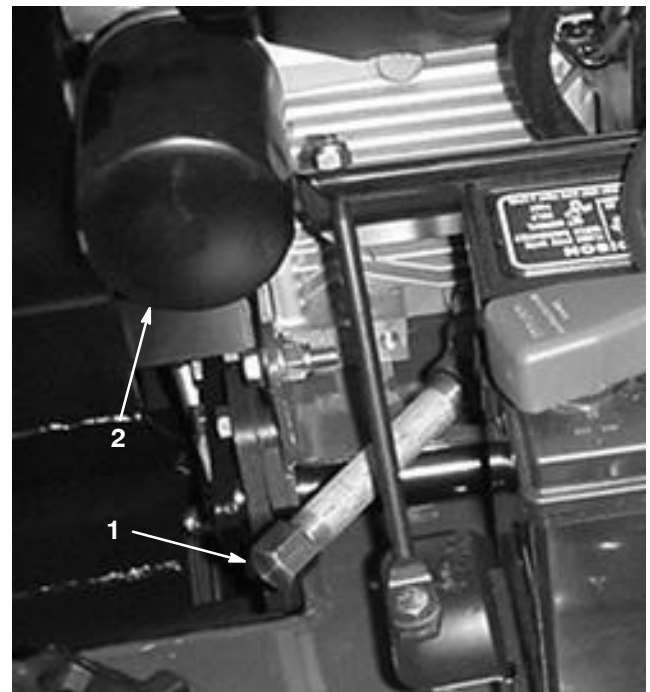

Figure 18

1. Oil drain plug
2. Oil filter

8. Slowly fill crankcase to the **F** mark on the dipstick. Always check the oil level with the dipstick before adding more oil. **DO NOT OVERFILL.**

Use high-quality engine oil that meets the following specifications:

API Classification Level Required: SJ, SK, SL, or higher.

Preferred oil: SAE 10W-30 (above 0° F)

Toro Premium Engine oil is available from your distributor in 10W-30 viscosity. See the parts catalog for part numbers.

9. Reinstall dipstick and oil cap and tighten securely.
10. Start the engine and check for oil leaks. Correct any leaks before placing engine into service. Check oil to make sure it is up to but not over the **F** mark on the dipstick.

Important To prevent extensive engine wear or damage, always maintain the proper oil level in the crankcase. Never operate the engine with the oil level below the **L** mark or over the **F** mark on the dipstick.

General Precleaner and Air Cleaner Maintenance

The engine is equipped with a replaceable, high density paper air cleaner element and an oiled foam precleaner which surrounds the paper element.

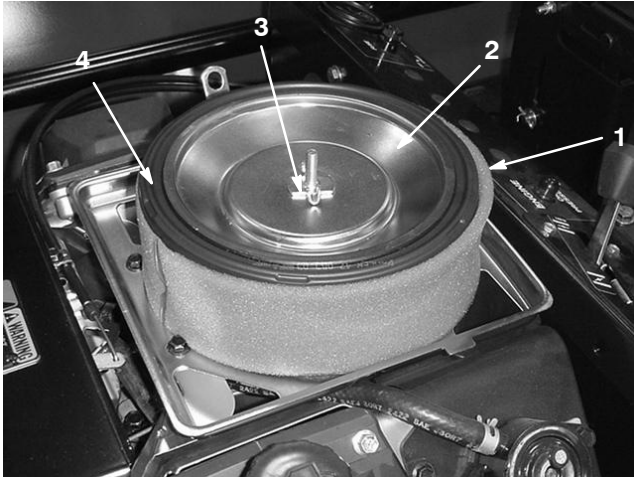

Figure 19

1. Precleaner
2. Air cleaner cover
3. Air cleaner cover nut
4. Air cleaner

Check the air cleaner daily before starting the engine. Check for buildup of dirt and debris around the cleaner system. Keep this area clean. Also check for loose or damaged components. Replace all bent or damaged air cleaner components.

Note: Operating the engine with loose or damaged air cleaner components could allow unfiltered air into the engine, causing premature wear and failure.

Clean and Lubricate Foam Precleaner

Wash and reoil precleaner every 25 hours of operation (more often if under extremely dusty and dirty conditions).

1. Turn engine off, set parking brake, and remove key from ignition switch.
2. Loosen the air cleaner cover knob and remove air cleaner cover.

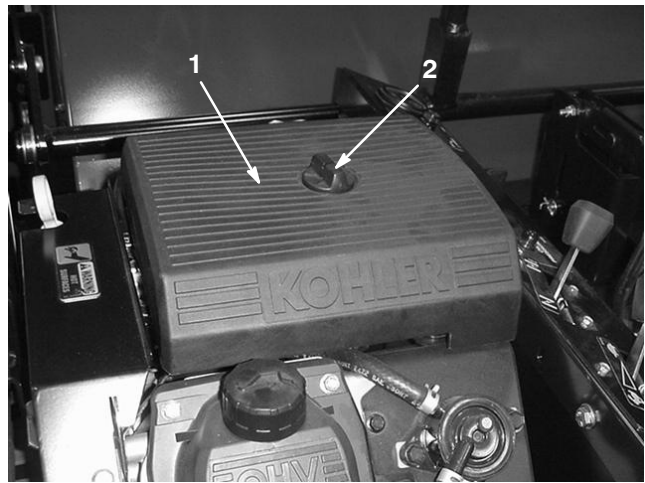

Figure 20

1. Air cleaner cover
2. Air cleaner cover knob

3. Remove precleaner from paper element.
4. Wash precleaner in warm water with detergent. Rinse precleaner thoroughly until all traces of detergent are eliminated. Squeeze out excess water. (Do not wring.) Allow precleaner to air dry.
5. Saturate the precleaner with new engine oil. Squeeze out excess oil.
6. Reinstall the precleaner over the air cleaner.
7. Reinstall the air cleaner cover. Secure cover with retaining knob.

Service Air Cleaner Paper Element

Every 100 hours of operation (more often under extremely dusty or dirty conditions) check the air cleaner paper element. Replace the element as necessary.

1. Turn engine off, set parking brake, and remove key from ignition switch.
2. Loosen the cover retaining knob and remove cover.
3. Remove the precleaner from the air cleaner paper element.
4. Remove air cleaner cover nut, air cleaner cover, and air cleaner paper element.
5. Do not wash the air cleaner paper element or use pressurized air, as this will damage element. Replace a dirty, bent, or damaged element. Handle now elements carefully; do not use if the sealing surfaces are bent or damaged.

- When servicing air cleaner, check the air cleaner base. Make sure it is secured and not bent or damaged. Check element cover for damage or improper fit. Replace all damaged air cleaner components.

Note: Before reassembling air cleaner make sure rubber seal is in position around stud. Inspect and make sure it is not damaged. Seal with the element cover.

- Reinstall the air cleaner paper element, precleaner, element cover, element cover nut, and air cleaner cover. Secure cover with retaining knob.

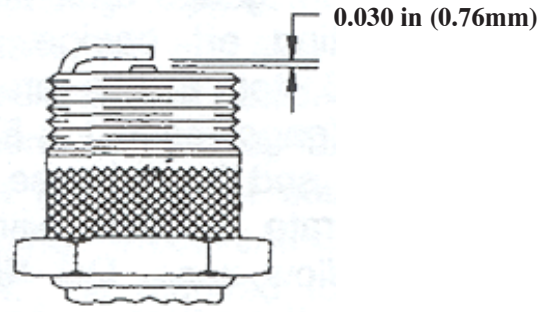

Figure 21

Clean Air Intake/Cooling Areas

To ensure proper cooling, chuck and clean grass screen, cooling fins, and other external surfaces of the engine daily.

Every 100 hours of operation (more often under extremely dusty or dirty conditions), remove the blower housing and other cooling shrouds. Clean the cooling fins and external surfaces as necessary. Make sure the cooling shrouds are reinstalled.

Important Operating the engine with a blocked grass screen, dirty or plugged cooling fins, and/or cooling shrouds removed will cause damage due to overheating.

Check Spark Plug Gap and Condition

Air gap between center and side electrodes of the spark plug increases gradually during normal operation of the engine. Check condition of electrodes after 200 hours of operation. Recommended air gap is 0.030 in. (0.76 mm).

Important A cracked, fouled, dirty, or otherwise malfunctioning spark plug must be replaced. Do not sand blast, scrape, or clean electrodes by using a wire brush because grit may eventually release from the plug and fall into the cylinder. The result is usually a damaged engine.

- Turn engine off, set parking brake, and remove key from ignition switch.
- Before removing spark plug, clean the area around the base of the plug to keep dirt and debris out of the engine.
- Remove plug and check condition of side and center electrodes, and center insulator to assure there is no damage. Replace plug if worn or if reuse is questionable.
- Check the gap using a wire feeler gauge. Adjust the gap between center and side electrodes to 0.030 in, (0.76mm) by carefully bending the ground electrode.
- Reinstall spark plug into the cylinder head. Torque spark plug to 18–22 ft. lb.
- Replace high tension leads onto spark plugs.

Changing Hydraulic Oil And Filter

The hydraulic oil must be changed yearly. The hydraulic oil filter must be changed initially at 50 hours, and thereafter yearly. The hydraulic oil and/or filter must also be changed if hydraulic vacuum gauge reads, and stays, in the red zone. The hydraulic system is designed to operate on Mobil DTE 13M or equivalent ISO VG 32 wide-temperature, shear-stable hydraulic fluid with controlled

low-temperature flow properties and anti-wear protection. The reservoir is filled at the factory with approximately 28 quarts of Mobil DTE 13M hydraulic fluid. Hydraulic oil viscosity (weight) must be selected according to average anticipated ambient temperature. Temperature/viscosity recommendations are as follows:

Expected Ambient Temperatures		
Recommended Oil	Start-Up	Average Daily Temperature
Mobil DTE 13M or equivalent ISO VG 32	Less than 40° F–50° F (4.5° C–10° C)	Less than 80° F (26.7° C)
Mobil DTE 26 or equivalent ISO VG 68	Greater than 60° F–70° F (15.5° C–21° C)	Greater than 80° F (26.7° C)

Important Using Mobil DTE 26 or equivalent ISO VG 68 hydraulic oil when temperatures average below 80° F (26.7° C) could cause serious hydraulic system damage.

The hydraulic vacuum gauge measures the vacuum levels within the hydraulic system. When the hydraulic oil filter becomes dirty, the vacuum level within the system will increase. The vacuum level will also increase if the wrong viscosity oil is used. (Refer to Expected Ambient Temperatures table.) Check vacuum gauge after each day's operation, and before shutting off engine. The hydraulic vacuum gauge (Fig. 6, Item 8) has three color-coded zones: the green zone (gauge reads 1 – 5), the yellow zone (gauge reads 4 – 6), and the red zone (gauge reads 7 – 31). It is safe to operate machine with gauge reading in the green or yellow zone. DO NOT continue to operate machine with the gauge in the red zone. The hydraulic oil and/or filter must be changed before operation can continue.

Note: When machine is first started and before the hydraulic oil has had time to reach a stable operating temperature (after approximately 2 hours of contiguous operation), the vacuum gauge may read in the red zone. For an accurate reading allow oil to reach a stable operating temperature before checking vacuum gauge.

Important Do not continue to operate machine if hydraulic vacuum gauge remains in the red zone after hydraulic oil has reached stable operating temperature. Continuing to operate machine with gauge in the red zone may cause serious system damage.

Important If hydraulic oil becomes contaminated, contact your local Authorized TORO Distributor because the system must be flushed. Contaminated oil looks milky or black when compared to clean oil. Continuing to operate machine with contaminated hydraulic all could cause system damage.

1. Position machine on a level surface shut engine off, set parking brake, and remove key from the ignition switch.
2. Remove drain plug (located under the floorboard on left-hand side) from reservoir and let hydraulic oil flow into drain pan. Reinstall and tighten plug when hydraulic oil stops draining.

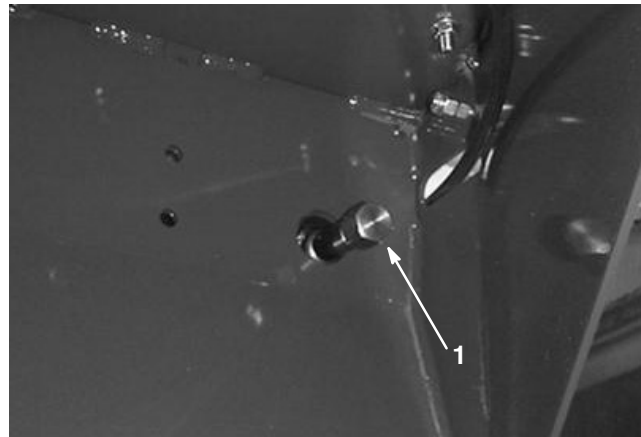

Figure 22

1. Hydraulic oil drain plug

3. Clean area around hydraulic oil filter mounting area and remove filter using a filter wrench.

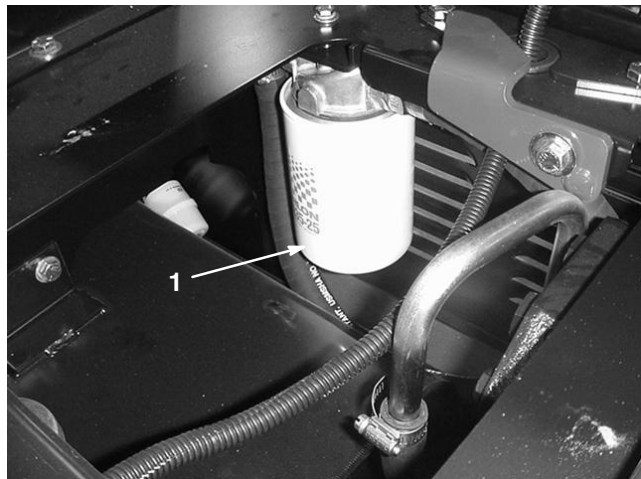

Figure 23

1. Hydraulic oil filter

4. Lubricate the sealing gasket and hand turn until gasket contacts filter head. Then tighten 3/4 turn further, filter should now be seated.
5. Fill the hydraulic tank with approximately 28 quarts of the proper hydraulic fluid.

Important To prevent system contamination, clean top of hydraulic oil containers before opening. Assure pour spout and funnel are clean. When adding oil to the hydraulic system, use a funnel with a fine screen (200

mesh) and ensure funnel and oil are clean. This procedure prevents accidental contamination of the hydraulic oil which will damage the hydraulic system.

6. Place all controls in the neutral or disengaged position and start engine. Run engine at idle for 3–5 minutes to circulate hydraulic fluid and remove any air trapped in the system. Stop the engine and re-check the fluid level. (Refer to Check Hydraulic System Oil)
7. Check all connections for leaks.

⚠Danger⚠

HYDRAULIC FLUID ESCAPING UNDER PRESSURE CAN PENETRATE SKIN AND DO SERIOUS DAMAGE.

- **Keep body and hands away from pin hole leaks or nozzles that eject high pressure hydraulic fluid. Use a cardboard or paper to find hydraulic leaks. Fluid accidentally injected into the skin must be surgically removed within a few hours by a doctor familiar with this form of injury or gangrene may result.**

Checking Hydraulic Lines and Hoses

After every 100 hours of operation, check hydraulic lines and hoses for leaks, kinked lines, loose mounting supports, wear, loose fittings, weather deterioration, and chemical deterioration. Make all necessary repairs before operating.

Fuel Filter Replacement

A 15 micron in-line filter is incorporated into the fuel line. Replace fuel filter after 100 hours of operation.

1. Place a drain pan under filter.
2. Clamp both fuel lines that connect to fuel filter so gasoline cannot drain when lines are removed.

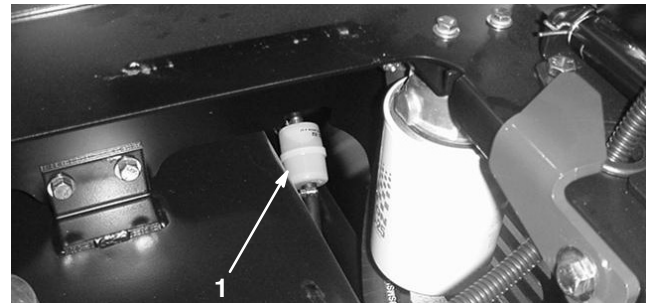

Figure 24

1. Fuel filter
3. Loosen the hose clamps at both ends of the filter and pull lines off filter.
4. Install new filter with arrow on the filter body pointing toward fuel pump.
5. Secure with hose clamps.

Sweeper Reel Height Adjustment

The operator can freely alternate between two set heights while sweeping. Higher settings may be required to sweep taller turf and also avoid scalping on rough terrain. It should also be noted that when scalping occurs mud and debris will build up inside of the hopper throat. This debris build-up will cause clogging and lower the sweeping effectiveness. Lowering the sweeping height will be required to compensate for finger wear and shorter turf. To adjust the height of the two set sweeping settings:

1. Position machine on a level surface, shut the engine off, set the parking brake, and remove the key from the ignition switch.
2. Remove the belt guards.
3. Locate the reel height adjusting nuts on both sides of the machine.
4. Move the engagement handle to the High or Low setting. Move the adjusting nuts so the front reel is at desired level. Maximum distance between end of fingers and ground is 2 1/8 inches with new fingers and in high position.
5. Tighten reel height adjusting nuts.

6. Adjust the left-hand side. It is very important that the left side and right side are adjusted equally (from the frame). Do not use the floor to adjust the perpendicularity of the reel shaft to the sweeper frame.
7. Verify that there is no interference when the PTO engagement handle is in OFF position.

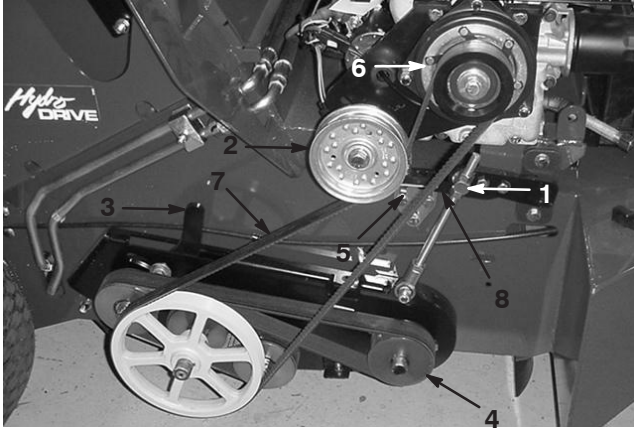

Figure 25

- | | |
|--|-----------------------------|
| 1. Reel height adjusting nut (right hand side) | 5. Clutch switch adjustment |
| 2. Upper idler | 6. Electric clutch/brake |
| 3. Idler adjusting arm | 7. Upper drive belt |
| 4. Front reel pulley | 8. Clutch switch flag |

Belt Removal/Installation

1. Position machine on a level surface, shut the engine off, set the parking brake and remove the key from the ignition switch.
2. Remove belt guards.
3. The upper or lower belt can be removed or installed without removing both belts.
4. To remove the upper belt, loosen the upper idler (Fig. 25) and remove belt from machine.
5. To install upper belt, first verify that the upper idler (Fig. 25) is loosened and slides freely. Install belt on machine. To tighten idler, push down on idler with approximately 30 lbs. of force and tighten idler bolt. Do not use a lever for mechanical advantage. **Do not over tension belt. An over-tensioned belt can cause premature failure or wear. The electric clutch and other reel drive components are subject to damage when belts are over-tensioned.**
6. To remove lower reversing belt, loosen the two bolts on the rear idler adjustment arm (Fig. 25). Move adjustment arm forward and remove belt.
7. To install lower reversing belt, push idler adjustment arm forward. Install reversing belt.

Note: The inside and outside of the belt are not the same. When looking at the front reel pulley (Fig. 25), with the belt installed, there should be two wide grooves on either side visible. Tighten the idler adjustment arm by pulling rearward with approximately 30 lbs. Torque both clamping bolts to 48 ft-lbs. Do not use a lever or a pry-bar for mechanical advantage when tensioning the belt with the idler adjustment arm.

8. Re-tension new belts after 10 hours of operation.



Caution



An incorrectly adjusted reel switch may cause unintended engagement of the reels and could cause injury.

Clutch Switch Adjustment

The clutch switch should never need adjusting. If the clutch fails to engage or disengage according to the position of the Reel PTO Engagement Handle, adjust the clutch switch.

1. Position machine on a level surface, shut the engine off, set parking brake and remove the key from the ignition switch.
2. Inspect the complete reel lift system including the reel engagement handle. Look for any worn or bent components that may cause the engagement switch to be out of adjustment.
3. Replace or repair any damaged components.

If all reel lift system components are in proper condition, adjust the reel switch bracket.

1. Place the PTO engagement handle in the OFF position.
2. Loosen the three bolts on the clutch switch bracket (Fig. 25).
3. Slide the clutch switch bracket until there is 1/8" of the clutch switch flag (Fig. 25) protruding through the bottom of the clutch switch bracket.
4. Tighten the three bolts and reassemble in reverse order.

Electric Brake Clutch Adjustment

Every 200 hours check for proper air gap on the electric clutch brake. Failure to maintain the correct air gap could result in clutch not engaging even though it is electrically energized.

1. Position machine on a level surface, shut the engine off, set the parking brake and remove the key from the ignition switch.

2. Adjust the air gap to .018" (.5mm) by inserting a thickness gauge into the clutch inspection slots. Evenly tighten the three lock nuts on clutch to reduce the air gap.



Figure 26

1. Brake clutch inspection slot (3)

Clutch Testing

1. Position machine on a level surface with the engine off, parking brake off, and the key removed from ignition switch.
2. Disconnect the wire connector and connect a continuity tester or ohm meter across the terminals of the clutch wire connector. There should be continuity across the terminals of the clutch connector. Resistance measured through the clutch coil should be 3.03 ohms \pm 5%. The clutch can also be tested by connecting a 12 V DC battery across the clutch connector terminals. The clutch should engage as 12V DC is connected to the clutch connector terminals.

Adjusting Parking Brake

Check adjustment every 200 hours of operation.

1. Position machine on a level surface with the engine off and the key removed from the ignition switch.
2. Rotate knob until a force of 40–50 lb. is required to actuate lever.
3. Tighten set screw after adjustment has been made.

Adjusting Traction Pedal

If the machine moves in either direction when traction pedal is in the neutral position, the traction cam must be adjusted.

1. Position machine on a level surface, shut the engine off, and remove the key from the ignition switch. Do not set the parking brake.

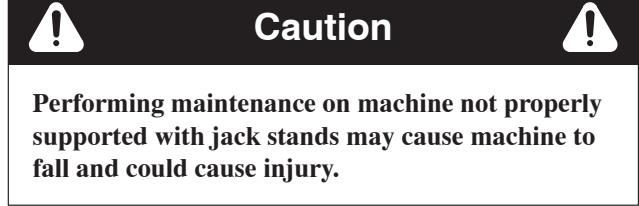

2. Raise one rear wheel off floor and support with jack stands under frame.
3. Loosen locknut on traction adjustment cam (located under operators seat).

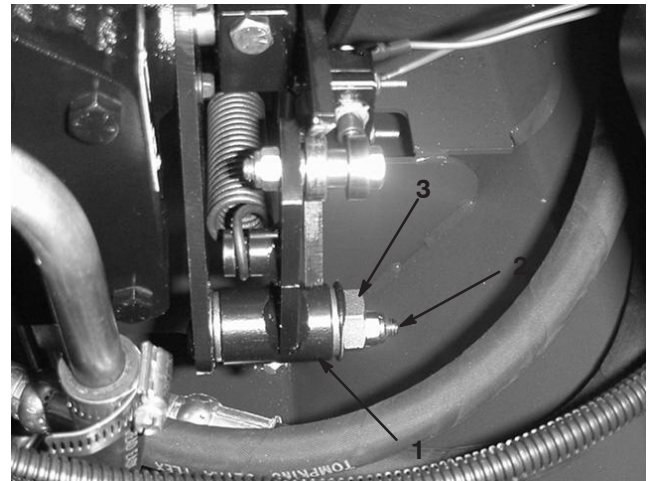
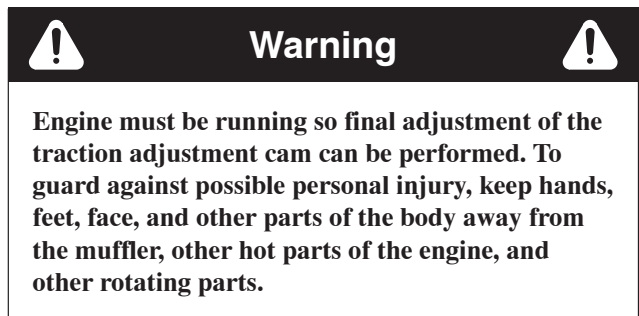

Figure 27

1. Traction adjustment cam
2. Locknut
3. Cam hex



4. Start engine and rotate cam hex in both directions to determine mid-position of neutral span.
5. Tighten locknut securing adjustment.
6. Always tighten both nuts when final adjustments are completed.
7. Stop engine. Remove jack stands and lower machine to shop floor.

8. Test drive machine to be sure it does not creep.

Steering Chain Adjustment

The steering chain should be adjusted after 100 hours of operation or when steering system is binding or excessive play in the column occurs.

1. Adjust steering chain idler, by applying 5 lbs. of force to the midpoint of the chain, until it deflects 0.25 inches.

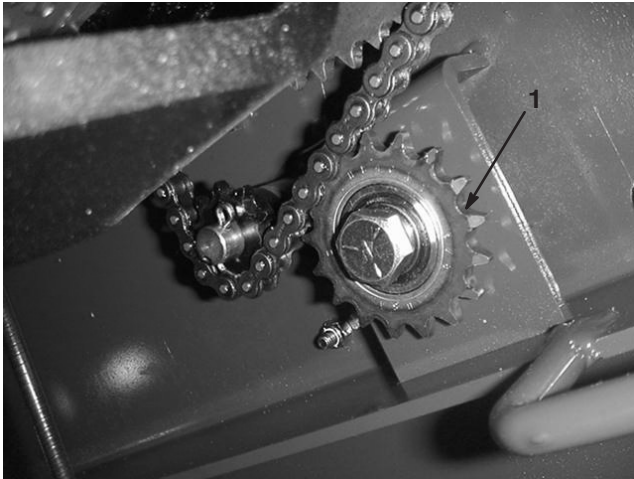

Figure 28

1. Steering chain idler

Replacing Sweeper Reel Fingers

Check condition of sweeper reel fingers after every 25 hours of operation. Excessively worn or damaged sweeper reel fingers will affect the sweepers ability to effectively pick up debris and must be replaced.

The Rubber Finger Puller (TORO Part No. 48-002-5691) can be used to remove and install reel fingers.

To install new reel fingers:

1. Place the reel finger in the slot and pull as far as possible.
2. Place the end of the puller on the finger.
3. Push down on puller to install finger.

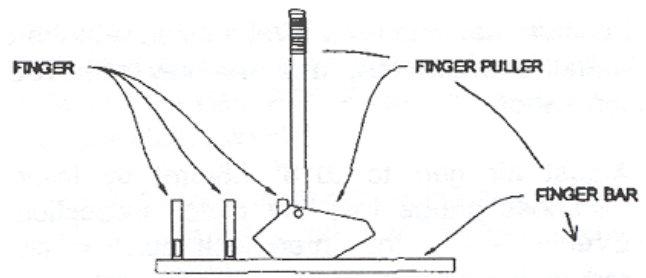

Figure 29

Note: The puller may be used in either direction for right or left handed use.

To remove reel fingers:

1. Place the end of the puller on the finger.
2. Push down in the same manner as installing the reel finger.

Hopper and Reel Clean Out

1. Position machine on a level surface, shut the engine off, set the parking brake, and remove the key from the ignition switch.
2. Open hopper door and lock the door open by loosening the locking knob (Fig. 10) and sliding bolt into notch. Tighten locking knob.
3. Remove debris from hopper and reel area.

Wheel Motor Axle Nut Torque

	Warning	
<p>Failure to maintain proper torque could result in failure or loss of wheel and may result in personal injury. Torque wheel motor axle nuts to 200 – 400 ft. lb.</p>		



Figure 30

1. Wheel motor axle nut

Battery Storage

If the machine will be stored for more than 30 days, remove the battery and charge it fully. Either store it on the shelf or on the machine. Leave cables disconnected if stored on the machine. Store the battery in a cool atmosphere to avoid quick deterioration of the charge in the battery. To prevent battery from freezing, make sure it is fully charged. The specific gravity of a fully charged battery is 1.250.



Figure 31

1. Battery cover

Battery Care

1. Battery electrolyte level must be properly maintained and the top of the battery kept clean. If the machine is stored in a location on where temperatures are extremely high, the battery will run down more rapidly than if the machine is stored in a location where temperatures are cool.
2. Keep top of battery clean by washing periodically with a brush dipped in ammonia or bicarbonate of soda solution. Flush the top surface with water after cleaning. Do not remove the fill cap while cleaning.

⚠
Danger
⚠

Battery electrolyte contains sulfuric acid which is a deadly poison and causes severe burns.

- Do not drink electrolyte and avoid contact with skin, eyes or clothing. Wear safety glasses to shield your eyes and rubber gloves to protect your hands.
- Fill the battery where clean water is always available for flushing the skin.

⚠
Warning
⚠

CALIFORNIA

Proposition 65 Warning

Battery posts, terminals, and related accessories contain lead and lead compounds, chemicals known to the State of California to cause cancer and reproductive harm. Wash hands after handling.

3. Check battery cable connections every 50 hours of operation. Battery cables must be tight on terminals to provide good electrical contact.

⚠
Warning
⚠

Incorrect battery cable routing could damage the tractor and cables causing sparks. Sparks can cause the battery gasses to explode, resulting in personal injury.

- Always *disconnect* the negative (black) battery cable before disconnecting the positive (red) cable.
- Always *connect* the positive (red) battery cable before connecting the negative (black) cable.

4. If corrosion occurs at terminals, remove battery cover, disconnect cables, negative (-) cable first and scrape clamps and terminals separately. Reconnect cables, positive (+) cable first and coat terminals with Grafo 112X skin over grease (TORO Part Number 505-46) or petroleum jelly,
5. Check the electrolyte level every .50 hours of operation or, if machine is in storage, every 30 days.
6. Maintain cell level with distilled or demineralized water. Do not fill cells above bottom of the fill ring, inside each cell.

Troubleshooting

Condition	Possible Causes	Corrective Action
Sweeper Not Picking Up	<ol style="list-style-type: none"> 1. Missing or broken fingers. 2. Broken belt or improper tension. 3. Check sheaves for sheared key. 4. Finger height may be too low or too high. 5. Hopper floor not seated inside against the rear cross member. Unit may be picking up but throwing it through gap onto the ground. 6. Screen in top of hopper door may be clogged, blocking air flow. 7. Build up on bottom of oil tank compartment or rear reel deflector above front reel. 	<ol style="list-style-type: none"> 1. Replace missing or broken fingers. 2. Replace belt/adjust tension. 3. Replace key. 4. Adjust height. See Sweeper Reel Height Adjustment. 5. Bend hopper floor back to seal hopper. 6. Clean out screen blockage. 7. Clean off any buildup on these surfaces.
Excessive Vibration	<ol style="list-style-type: none"> 1. Check bearings on reel shaft. If they are excessively hot, they are probably damaged. 2. Foreign materials wrapped around reel shaft. 3. Reels could be bent. Should be within 0.015 for straightness. 4. Missing or broken sweeper fingers. 5. Damaged belt 	<ol style="list-style-type: none"> 1. Replace any damaged bearings. 2. Clean off any foreign objects. 3. Check shaft with dial calipers. 4. Replace fingers. 5. Replace belt.

Storage

1. Thoroughly clean the sweeper so it is free of dirt, leaves and debris.
2. Inflate tires to 22 psi.
3. Check all fasteners. Tighten as necessary.
4. Grease all grease fittings. Wipe off excess lubricant.
5. Drain and replace hydraulic fluid and filter. Inspect all hydraulic lines and fittings. Replace if necessary. Refer to the Maintenance section.
6. Check the tension and condition of the reel belts. Adjust the tension if necessary.
7. Check the condition of the rubber fingers. Replace any broken, missing, or worn fingers.
8. Service the battery and cables as follows:
 - A. Remove the battery terminals from the battery posts.
 - B. Clean the battery, terminals and posts with a wire brush and baking soda solution.

- C. Coat the cable terminals and battery posts with Grafo 112X skin over grease (TORO Part Number 505-46), or petroleum jelly to prevent corrosion.
- D. Slowly recharge the battery every 60 days for 24 hours to prevent lead sulfating of the battery.

Engine

1. Drain the engine oil from the crankcase and replace drain plug.
2. Remove and discard the oil filter. Install a new oil filter.
3. Refill crankcase pan with 2.1 quarts (2 liters) of SG or SH, 10W-30 motor oil.
4. Start the engine and run at idle speed for approximately two minutes.
5. Stop the engine.
6. Thoroughly drain all fuel from the fuel tank, lines and the fuel filter.
7. Flush the fuel tank with fresh, clean gasoline.
8. Re-secure all fuel system fittings.

Hydraulic Schematic

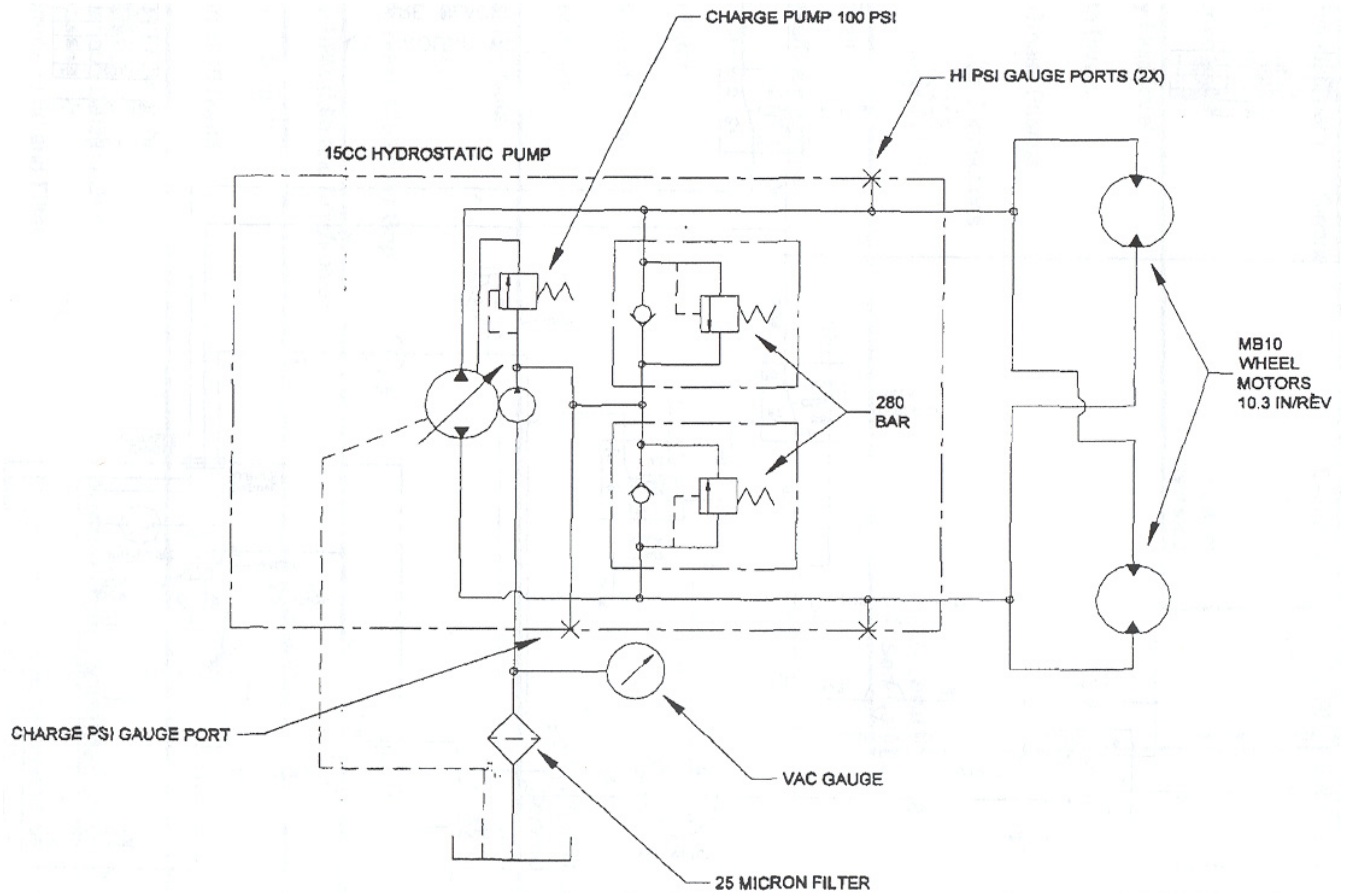

Electrical Schematic

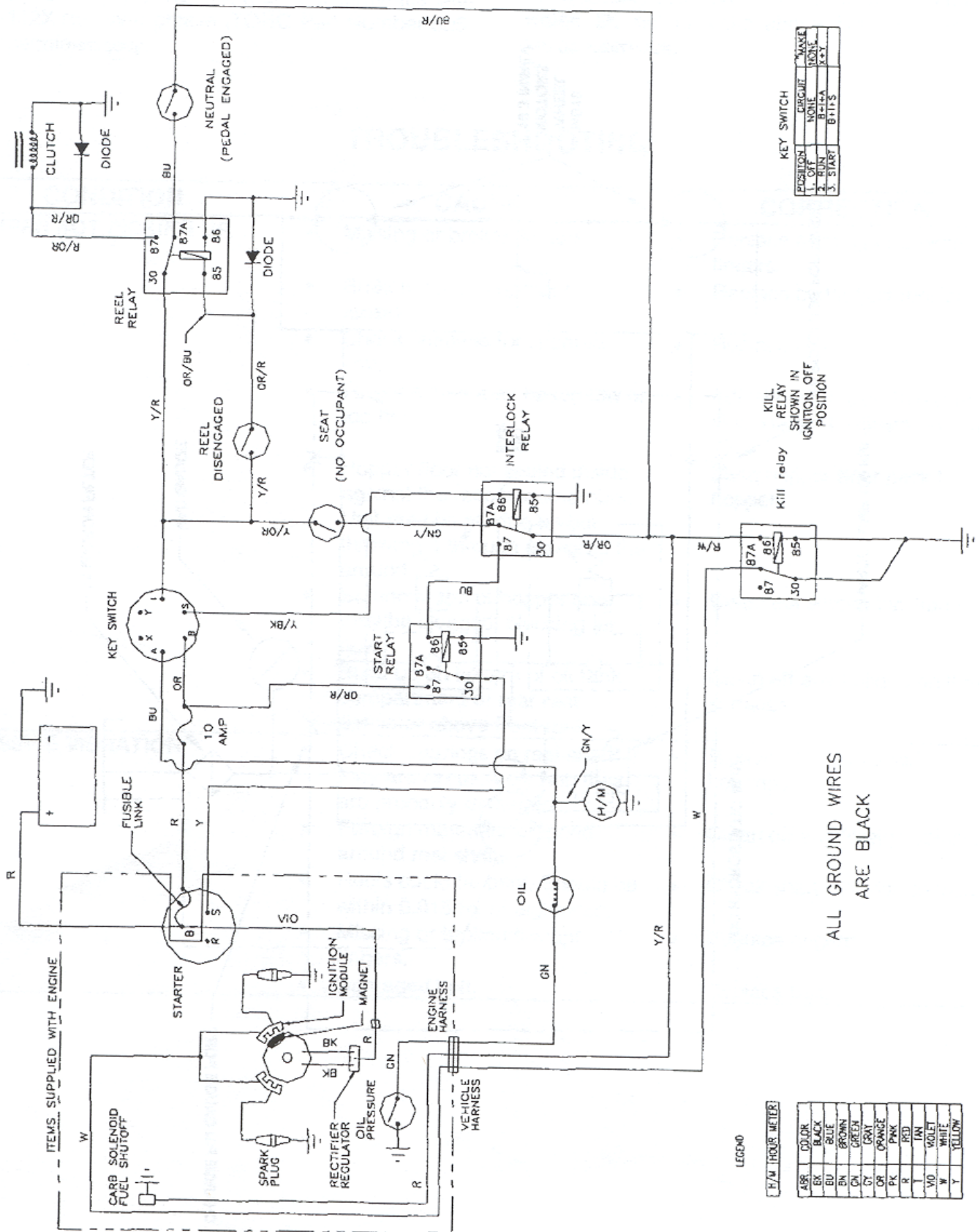

KEY SWITCH

POSITION	CIRCUIT	WIRING
1. OFF	NONE	None
2. RUN	B+12A	B+Y
3. START	B+12S	B+Y

LEGEND

F/M	HOUR	METER	COLOR
BR			BROWN
BL			BLACK
BU			BLUE
BN			BROWN
GN			GREEN
GY			GRAY
OR			ORANGE
PK			PINK
R			RED
Y			YELLOW
W			WHITE
Y			YELLOW



The Toro General Commercial Products Warranty

A Two-Year Limited Warranty

Conditions and Products Covered

The Toro Company and its affiliate, Toro Warranty Company, pursuant to an agreement between them, jointly warrant your Toro Commercial Product ("Product") to be free from defects in materials or workmanship for two years or 1500 operational hours*, whichever occurs first. Where a warrantable condition exists, we will repair the Product at no cost to you including diagnosis, labor, parts, and transportation. This warranty begins on the date the Product is delivered to the original retail purchaser.

* Product equipped with hour meter

Instructions for Obtaining Warranty Service

You are responsible for notifying the Commercial Products Distributor or Authorized Commercial Products Dealer from whom you purchased the Product as soon as you believe a warrantable condition exists.

If you need help locating a Commercial Products Distributor or Authorized Dealer, or if you have questions regarding your warranty rights or responsibilities, you may contact us at:

Toro Commercial Products Service Department
Toro Warranty Company
8111 Lyndale Avenue South
Bloomington, MN 55420-1196
952-888-8801 or 800-982-2740
E-mail: commercial.service@toro.com

Owner Responsibilities

As the Product owner, you are responsible for required maintenance and adjustments stated in your operator's manual. Failure to perform required maintenance and adjustments can be grounds for disallowing a warranty claim.

Items and Conditions Not Covered

Not all product failures or malfunctions that occur during the warranty period are defects in materials or workmanship. This express warranty does not cover the following:

- Product failures which result from the use of non-Toro replacement parts, or from installation and use of add-on, modified, or unapproved accessories
- Product failures which result from failure to perform required maintenance and/or adjustments
- Product failures which result from operating the Product in an abusive, negligent or reckless manner
- Parts subject to consumption through use unless found to be defective. Examples of parts which are consumed, or used up, during normal Product operation include, but are not limited to, blades, reels, bedknives, tines, spark plugs, castor wheels, tires, filters, belts, and certain sprayer components such as diaphragms, nozzles, and check valves, etc.

Countries Other than the United States or Canada

Customers who have purchased Toro products exported from the United States or Canada should contact their Toro Distributor (Dealer) to obtain guarantee policies for your country, province, or state. If for any reason you are dissatisfied with your Distributor's service or have difficulty obtaining guarantee information, contact the Toro importer. If all other remedies fail, you may contact us at Toro Warranty Company.

- Failures caused by outside influence. Items considered to be outside influence include, but are not limited to, weather, storage practices, contamination, use of unapproved coolants, lubricants, additives, or chemicals, etc.
- Normal "wear and tear" items. Normal "wear and tear" includes, but is not limited to, damage to seats due to wear or abrasion, worn painted surfaces, scratched decals or windows, etc.

Parts

Parts scheduled for replacement as required maintenance are warranted for the period of time up to the scheduled replacement time for that part.

Parts replaced under this warranty become the property of Toro. Toro will make the final decision whether to repair any existing part or assembly or replace it. Toro may use factory remanufactured parts rather than new parts for some warranty repairs.

General Conditions

Repair by an Authorized Toro Distributor or Dealer is your sole remedy under this warranty.

Neither The Toro Company nor Toro Warranty Company is liable for indirect, incidental or consequential damages in connection with the use of the Toro Products covered by this warranty, including any cost or expense of providing substitute equipment or service during reasonable periods of malfunction or non-use pending completion of repairs under this warranty. Except for the Emissions warranty referenced below, if applicable, there is no other express warranty. All implied warranties of merchantability and fitness for use are limited to the duration of this express warranty.

Some states do not allow exclusions of incidental or consequential damages, or limitations on how long an implied warranty lasts, so the above exclusions and limitations may not apply to you.

This warranty gives you specific legal rights, and you may also have other rights which vary from state to state.

Note regarding engine warranty: The Emissions Control System on your Product may be covered by a separate warranty meeting requirements established by the U.S. Environmental Protection Agency (EPA) and/or the California Air Resources Board (CARB). The hour limitations set forth above do not apply to the Emissions Control System Warranty. Refer to the Engine Emission Control Warranty Statement printed in your operator's manual or contained in the engine manufacturer's documentation for details.