





Reelmaster[®] 4000-D

Traction Unit

Model No. 03706—230000001 and Up

Model No. 03707—230000001 and Up

Operator's Manual

	Warning	
CALIFORNIA		
Proposition 65 Warning		
Diesel engine exhaust and some of its constituents are known to the State of California to cause cancer, birth defects, and other reproductive harm.		

Important The engine in this product is not equipped with a spark arrester muffler. It is a violation of California Public Resource Code Section 4442 to use or operate this engine on any forest-covered, brush-covered, or grass-covered land as defined in CPRC 4126. Other states or federal areas may have similar laws.

Contents

	Page
Introduction	3
Safety	3
Safe Operating Practices	3
Toro Riding Mower Safety	5
Sound Pressure Level	6
Sound Power Level	6
Vibration Level	6
Safety and Instruction Decals	7
Specifications	12
General Specifications	12
Measurements	13
Optional Equipment	13
Before Operating	14
Checking the Engine Oil	14
Check Cooling System	14
Fill Fuel Tank	15
Checking the Hydraulic Fluid	15
Check Reel To Bedknife Contact	16
Check Tire Pressure	16
Rear Ballast	16

	Page
Operation	17
Controls	17
Starting And Stopping	21
Bleeding Fuel System	21
Checking Warning Indicator Lights	21
Checking Interlock System.	22
Pushing Or Towing Traction Unit	22
Operating Characteristics	23
Maintenance	26
Recommended Maintenance Schedule	26
Daily Maintenance Checklist	27
Lubrication	28
General Air Cleaner Maintenance	29
Servicing Air Cleaner	29
Engine Oil And Filter	29
Fuel System	30
Engine Cooling System	31
Alternator Belt	32
Adjusting Hand Brake & Traction Switches	32
Adding Hydraulic Oil	33
Draining Water From Hydraulic Reservoir	33
Changing Hydraulic Oil	34
Replacing Hydraulic Filter	34
Replacing Hydraulic System Breather	34
Checking Hydraulic Lines And Hoses	35
Hydraulic System Test Ports	35
Rear Wheel Toe-in	35
Checking Planetary Gear Drive	36
Engine Valve Clearance	36
Hydraulic Schematic	37
Electrical Schematic	38
Battery Care	39
The Toro General Commercial Products Warranty ..	40

Introduction

Read this manual carefully to learn how to operate and maintain your product properly. The information in this manual can help you and others avoid injury and product damage. Although Toro designs and produces safe products, you are responsible for operating the product properly and safely.

Whenever you need service, genuine Toro parts, or additional information, contact an Authorized Service Dealer or Toro Customer Service and have the model and serial numbers of your product ready. Figure 1 illustrates the location of the model and serial numbers on the product.

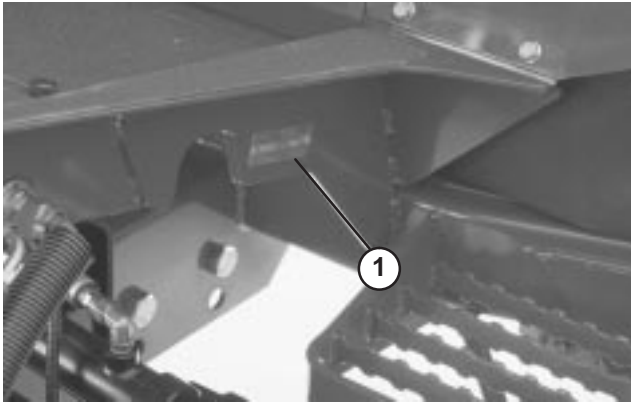

Figure 1

1. Location of the model and serial numbers

Write the product model and serial numbers in the space below:

Model No. _____
Serial No. _____

This manual identifies potential hazards and has special safety messages that help you and others avoid personal injury and even death. **Danger**, **Warning**, and **Caution** are signal words used to identify the level of hazard. However, regardless of the hazard, be extremely careful.

Danger signals an extreme hazard that *will* cause serious injury or death if you do not follow the recommended precautions.

Warning signals a hazard that *may* cause serious injury or death if you do not follow the recommended precautions.

Caution signals a hazard that may cause minor or moderate injury if you do not follow the recommended precautions.

This manual uses two other words to highlight information.

Important calls attention to special mechanical information and **Note** emphasizes general information worthy of special attention.

Safety

This machine meets or exceeds CEN standard EN 836:1997 (when appropriate decals applied), and ANSI B71.4-1990 specifications in effect at the time of production when rear tires are filled with calcium chloride and two rear wheel weight kits (Part No. 11-0440) are installed.

Improper use or maintenance by the operator or owner can result in injury. To reduce the potential for injury, comply with these safety instructions and always pay attention to the safety alert \blacktriangle symbol, which means CAUTION, WARNING, or DANGER—“personal safety instruction.” Failure to comply with the instruction may result in personal injury or death.

Safe Operating Practices

The following instructions are from the CEN standard EN 836:1997, ISO standard 5395:1990, and ANSI B71.4-1999.

Training

- Read the operator’s manual and other training material carefully. Be familiar with the controls, safety signs, and the proper use of the equipment.
- Never allow children or people unfamiliar with these instructions to use or service the mower. Local regulations may restrict the age of the operator.
- Never mow while people, especially children, or pets are nearby.
- Keep in mind that the operator or user is responsible for accidents or hazards occurring to other people or their property.
- Do not carry passengers.
- All drivers and mechanics should seek and obtain professional and practical instruction. The owner is responsible for training the users. Such instruction should emphasize:
 - the need for care and concentration when working with ride-on machines;
 - control of a ride-on machine sliding on a slope will not be regained by the application of the brake. The main reasons for loss of control are:
 - insufficient wheel grip;
 - being driven too fast;

- inadequate braking;
 - the type of machine is unsuitable for its task;
 - lack of awareness of the effect of ground conditions, especially slopes;
 - incorrect hitching and load distribution.
- The owner/user can prevent and is responsible for accidents or injuries occurring to himself or herself, other people, or property.

Preparation

- While mowing, always wear substantial footwear, long trousers, hard hat, safety glasses, and ear protection. Long hair, loose clothing, or jewelry may get tangled in moving parts. Do not operate the equipment when barefoot or wearing open sandals.
 - Thoroughly inspect the area where the equipment is to be used and remove all objects which may be thrown by the machine.
 - **Warning**—Fuel is highly flammable. Take the following precautions:
 - Store fuel in containers specifically designed for this purpose.
 - Refuel outdoors only and do not smoke while refuelling.
 - Add fuel before starting the engine. Never remove the cap of the fuel tank or add fuel while the engine is running or when the engine is hot.
 - If fuel is spilled, do not attempt to start the engine but move the machine away from the area of spillage and avoid creating any source of ignition until fuel vapors have dissipated.
 - Replace all fuel tanks and container caps securely.
 - Replace faulty silencers/mufflers.
 - Evaluate the terrain to determine what accessories and attachments are needed to properly and safely perform the job. Only use accessories and attachments approved by the manufacturer.
 - Check that operator’s presence controls, safety switches and shields are attached and functioning properly. Do not operate unless they are functioning properly.
- Do not use on slopes of more than
 - 5° when mowing on side hills;
 - 10° when mowing uphill;
 - 15° when mowing downhill.
 - Remember there is no such thing as a safe slope. Travel on grass slopes requires particular care. To guard against overturning:
 - do not stop or start suddenly when going up or downhill;
 - engage clutch slowly, always keep machine in gear, especially when travelling downhill;
 - machine speeds should be kept low on slopes and during tight turns;
 - stay alert for humps and hollows and other hidden hazards;
 - never mow across the face of the slope, unless the mower is designed for this purpose.
 - Stay alert for holes in the terrain and other hidden hazards.
 - Use care when pulling loads or using heavy equipment.
 - Use only approved drawbar hitch points.
 - Limit loads to those you can safely control.
 - Do not turn sharply. Use care when reversing.
 - Use counterweight(s) or wheel weights when suggested in the operator’s manual.
 - Watch out for traffic when crossing or near roadways.
 - Stop the blades rotating before crossing surfaces other than grass.
 - When using any attachments, never direct discharge of material toward bystanders nor allow anyone near the machine while in operation.
 - Never operate the machine with damaged guards, shields, or without safety protective devices in place. Be sure all interlocks are attached, adjusted properly, and functioning properly.
 - Do not change the engine governor settings or overspeed the engine. Operating the engine at excessive speed may increase the hazard of personal injury.
 - Before leaving the operator’s position:
 - stop on level ground;
 - disengage the power take-off and lower the attachments;
 - change into neutral and set the parking brake;
 - stop the engine and remove the key.

Operation

- Do not operate the engine in a confined space where dangerous carbon monoxide fumes can collect.
- Mow only in daylight or in good artificial light.
- Before attempting to start the engine, disengage all blade attachment clutches, shift into neutral, and engage the parking brake.

- Disengage drive to attachments when transporting or not in use.
- Stop the engine and disengage drive to attachment
 - before refuelling;
 - before removing the grass catcher/catchers;
 - before making height adjustment unless adjustment can be made from the operator's position.
 - before clearing blockages;
 - before checking, cleaning or working on the mower;
 - after striking a foreign object or if an abnormal vibration occurs. Inspect the mower for damage and make repairs before restarting and operating the equipment.
- Reduce the throttle setting during engine run-out and, if the engine is provided with a shut-off valve, turn the fuel off at the conclusion of mowing.
- Keep hands and feet away from the cutting units.
- Look behind and down before backing up to be sure of a clear path.
- Slow down and use caution when making turns and crossing roads and sidewalks. Stop cylinders/reels if not mowing.
- Do not operate the mower under the influence of alcohol or drugs
- Use care when loading or unloading the machine into a trailer or truck
- Use care when approaching blind corners, shrubs, trees, or other objects that may obscure vision.
- Be careful during adjustment of the machine to prevent entrapment of the fingers between moving blades and fixed parts of the machine.
- On multi-cylinder/multi-reel machines, take care as rotating one cylinder/reel can cause other cylinders/reels to rotate.
- Disengage drives, lower the cutting units, set parking brake, stop engine and remove key and disconnect spark plug wire. Wait for all movement to stop before adjusting, cleaning or repairing.
- Clean grass and debris from cutting units, drives, silencers/mufflers, and engine to help prevent fires. Clean up oil or fuel spillage.
- Use jack stands to support components when required.
- Carefully release pressure from components with stored energy.
- Disconnect battery and remove spark plug wire before making any repairs. Disconnect the negative terminal first and the positive last. Reconnect positive first and negative last.
- Use care when checking the cylinders/reels. Wear gloves and use caution when servicing them.
- Keep hands and feet away from moving parts. If possible, do not make adjustments with the engine running.
- Charge batteries in an open well ventilated area, away from spark and flames. Unplug charger before connecting or disconnecting from battery. Wear protective clothing and use insulated tools.

Maintenance and Storage



- Keep all nuts, bolts and screws tight to be sure the equipment is in safe working condition.
- Never store the equipment with fuel in the tank inside a building where fumes may reach an open flame or spark.
- Allow the engine to cool before storing in any enclosure.
- To reduce the fire hazard, keep the engine, silencer/muffler, battery compartment and fuel storage area free of grass, leaves, or excessive grease.
- Check the grass catcher frequently for wear or deterioration.
- Keep all parts in good working condition and all hardware and hydraulic fittings tightened. Replace all worn or damaged parts and decals.
- If the fuel tank has to be drained, do this outdoors.

Toro Riding Mower Safety

The following list contains safety information specific to Toro products or other safety information that you must know that is not included in the ANSI standard.

This product is capable of amputating hands and feet and throwing objects. Always follow all safety instructions to avoid serious injury or death.

Use of this product for purposes other than its intended use could prove dangerous to user and bystanders.

	Warning	
<p>Engine exhaust contains carbon monoxide, which is an odorless, deadly poison that can kill you.</p> <p>Do not run engine indoors or in an enclosed area.</p>		

- Know how to stop the engine quickly.
- Do not operate the machine while wearing tennis shoes or sneakers.

- Wearing safety shoes and long pants is advisable and required by some local ordinances and insurance regulations.
- Handle fuel carefully. Wipe up any spills.
- Check the safety interlock switches daily for proper operation. If a switch should fail, replace the switch before operating the machine. After every two years, replace all four interlock switches in the safety system, whether they are working properly or not.
- Before starting the engine, sit on the seat.
- Using the machine demands attention. To prevent loss of control:
 - Do not drive close to sand traps, ditches, creeks, or other hazards.
 - Reduce speed when making sharp turns. Avoid sudden stops and starts.
 - When near or crossing roads, always yield the right-of-way.
 - Apply the service brakes when going downhill to keep forward speed slow and to maintain control of the machine.
- The grass baskets must be in place during operation of the cylinders/reels or thatchers for maximum safety. Shut the engine off before emptying the baskets.
- Raise the cutting units when driving from one work area to another.
- Do not touch the engine, silencer/muffler, or exhaust pipe while the engine is running or soon after it has stopped because these areas could be hot enough to cause burns.
- Stay clear of the rotating screen at the side of the engine to prevent direct contact with your body or clothing.
- If the engine stalls or loses headway and cannot make it to the top of a slope, do not turn the machine around. Always back slowly, straight down the slope.
- When a person or pet appears unexpectedly in or near the mowing area, **stop mowing**. Careless operation, combined with terrain angles, ricochets, or improperly positioned guards can lead to thrown object injuries. Do not resume mowing until the area is cleared.

Maintenance and Storage

- Make sure all hydraulic line connectors are tight and all hydraulic hoses and lines are in good condition before applying pressure to the system.
- Keep your body and hands away from pin hole leaks or nozzles that eject hydraulic fluid under high pressure. Use paper or cardboard, not your hands, to search for leaks. Hydraulic fluid escaping under pressure can have

sufficient force to penetrate the skin and cause serious injury. Seek immediate medical attention if fluid is injected into skin.

- Before disconnecting or performing any work on the hydraulic system, all pressure in the system must be relieved by stopping the engine and lowering the cutting units and attachments to the ground.
- Check all fuel lines for tightness and wear on a regular basis. Tighten or repair them as needed.
- If the engine must be running to perform a maintenance adjustment, keep hands, feet, clothing, and any parts of the body away from the cutting units, attachments, and any moving parts, especially the screen at the side of the engine. Keep everyone away.
- To ensure safety and accuracy, have an Authorized Toro Distributor check the maximum engine speed with a tachometer. Maximum governed engine speed should be 2900 RPM.
- The optional TORO tow bar (Part No. 58-7020) is for emergency towing only. Use only the special tow bar if it becomes necessary to tow machine. Use trailer for normal transport. Refer to page 21 for towing procedure.
- If major repairs are ever needed or if assistance is desired, contact an Authorized Toro Distributor.
- Use only Toro-approved attachments and replacement parts. The warranty may be voided if used with unapproved attachments.

Sound Pressure Level

This unit has an equivalent continuous A-weighted sound pressure level at the operator ear of 88 dBA, based on measurements of identical machines per Directive 98/37/EC and amendments.

Sound Power Level

This unit has a guaranteed sound power level of 105 dBA/1 pW, based on measurements of identical machines per Directive 2000/14/EC and amendments.

Vibration Level

Hand-Arm

This unit does not exceed a vibration level of 2.5 m/s² at the hands based on measurements of identical machines per ISO 5349 procedures.

Whole Body

This unit does not exceed a vibration level of 0.5 m/s² at the posterior based on measurements of identical machines per ISO 2631 procedures.

Safety and Instruction Decals



Safety decals and instructions are easily visible to the operator and are located near any area of potential danger. Replace any decal that is damaged or lost.

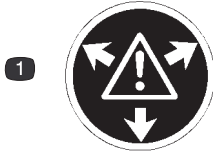

59-8440

1. Warning—contents under pressure.



93-6681

1. Cutting/dismemberment hazard, fan—stay away from moving parts.



76-8760

1. Danger—reels can cut hands of feet.

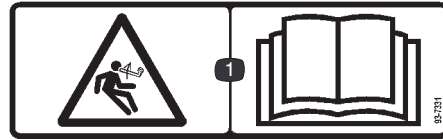

93-7331

1. Stored energy hazard—read the *Operator's Manual*.

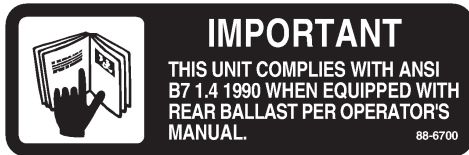

88-6700



93-6686

1. Hydraulic oil
2. Read the *Operator's Manual*.



93-6680

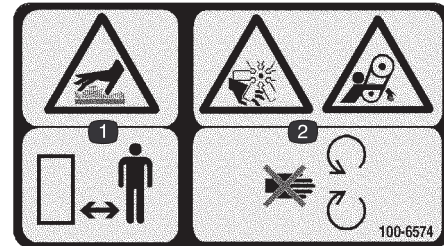

100-6574

1. Hot surface/burn hazard—stay a safe distance from the hot surface.
2. Cutting/dismemberment hazard, fan and entanglement hazard, belt—stay away from moving parts



93-9404

1. Engine coolant
2. Read the *Operator's Manual*.

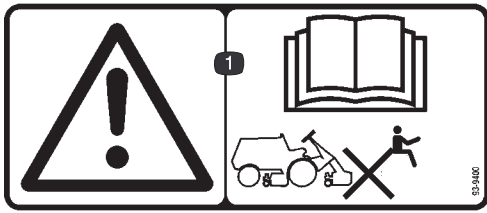

93-9400

1. Warning—read the *Operator's Manual*; do not tow the machine.

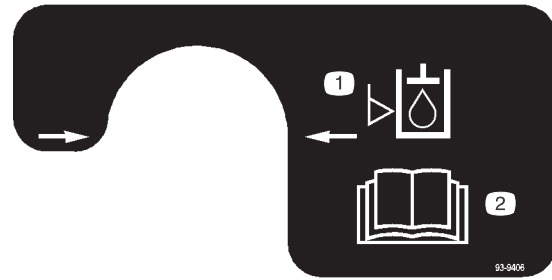

93-9406

1. Hydraulic oil level
2. Read the *Operator's Manual*.

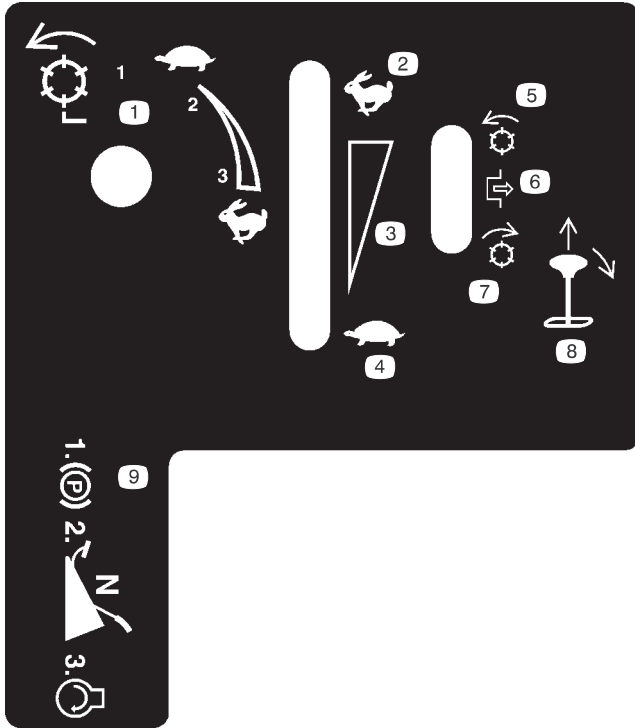

93-9402

1. Reel—mowing speeds, slow to fast.
2. Fast
3. Continuous variable setting
4. Fast
5. Reel—mowing
6. Disengage
7. Reel—backclapping
8. Pull and move the lever.
9. Set the parking brake, set the controls to neutral, and start the engine.

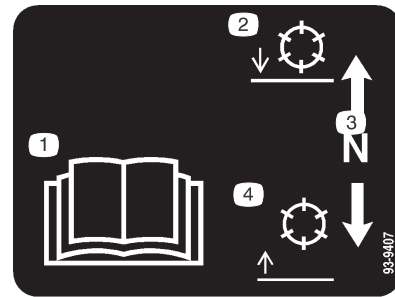

93-9407

1. Read the *Operator's Manual*.
2. Lower the reels.
3. Neutral
4. Raise the reels.

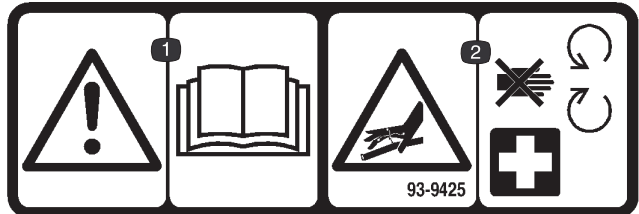

93-9425

1. Warning—read the *Operator's Manual*.
2. High pressure fluid hazard, injection into the body—stay away from moving parts and receive medical attention.



93-9405

1. Tire pressure—read the *Operator's Manual*; fill the front tires to 13 psi (0.9 bar) and the rear tires to 15 psi (1.0 bar).

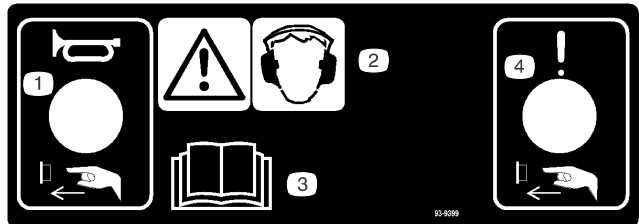

93-9399

1. Horn—press the button.
2. Warning—wear hearing protection.
3. Read the *Operator's Manual*.
4. Failure/malfunction—press the button.

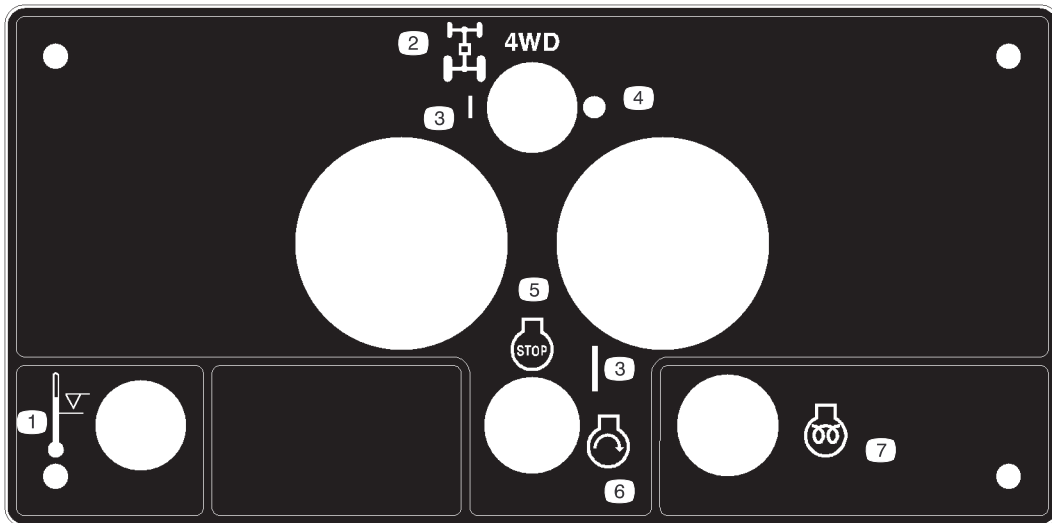

98-3830

- | | | | |
|----------------------------------|--------|-----------------|-------------------|
| 1. Temperature level | 3. On | 5. Engine—stop | 7. Engine—preheat |
| 2. Four wheel drive flow divider | 4. Off | 6. Engine—start | |

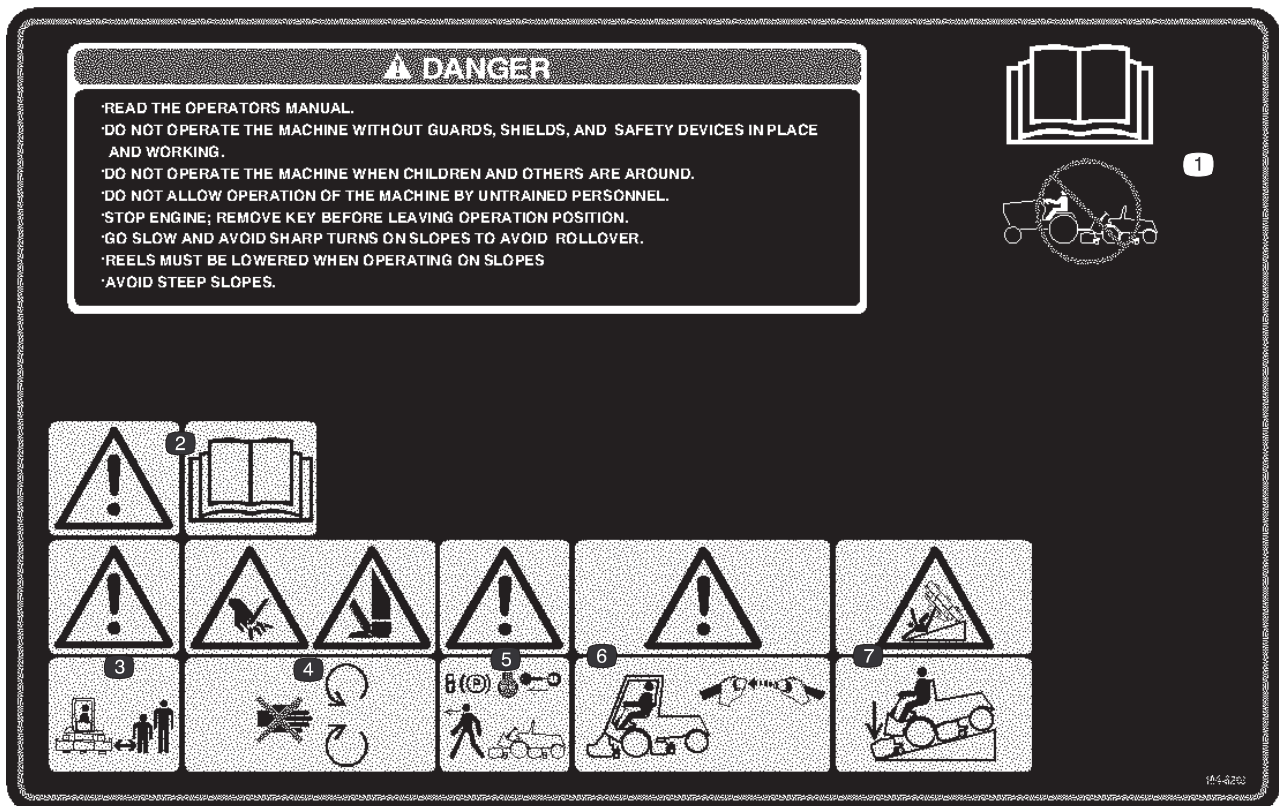

104-5203

- | | | | |
|---|--|---|--|
| 1. Read the <i>Operator's Manual</i> —do not tow the machine. | 3. Warning—keep bystanders a safe distance from the machine. | 5. Warning—lock the parking brake, stop the engine, and remove the ignition key before leaving the machine. | 7. Tipping hazard—lower the cutting unit when driving down slopes. |
| 2. Warning—read the <i>Operator's Manual</i> . | 4. Cutting hazard of hand or foot—stay away from moving parts. | 6. Warning—use a rollover protection system and wear the seat belt. | |

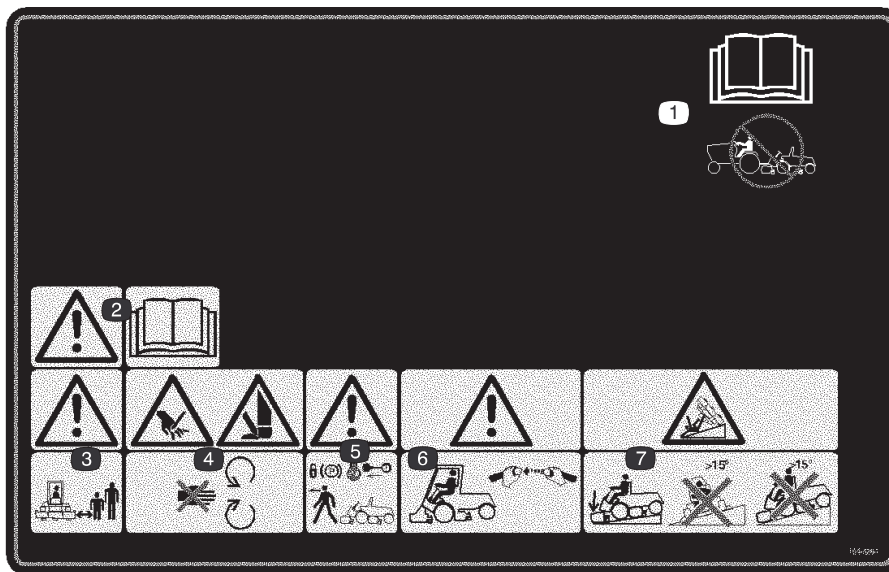

104-5204 for CE

1. Read the *Operator's Manual*—do not tow the machine.
2. Warning—read the *Operator's Manual*.
3. Warning—keep bystanders a safe distance from the machine.
4. Cutting hazard of hand or foot—stay away from moving parts.
5. Warning—lock the parking brake, stop the engine, and remove the ignition key before leaving the machine.
6. Warning—use a rollover protection system and wear the seat belt.
7. Tipping hazard—lower the cutting unit when driving down slopes. Do not drive the machine across or down a slope greater than 15 degrees.

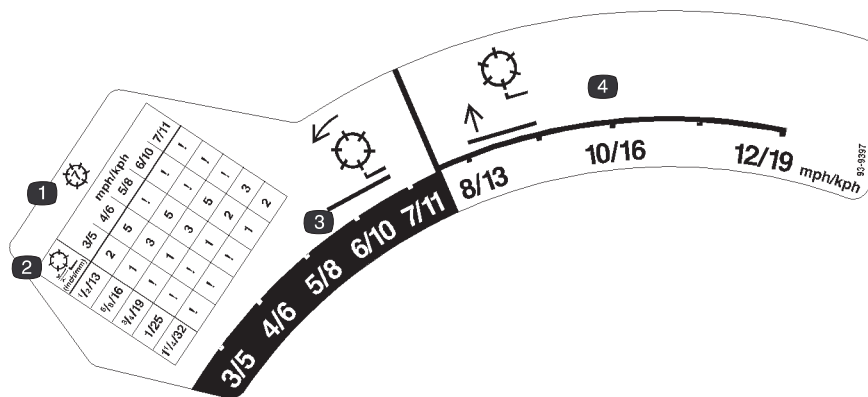

93-9397

1. 7-blade reel
2. Height of cut
3. Reel—mowing speeds
4. Reel—transport speeds

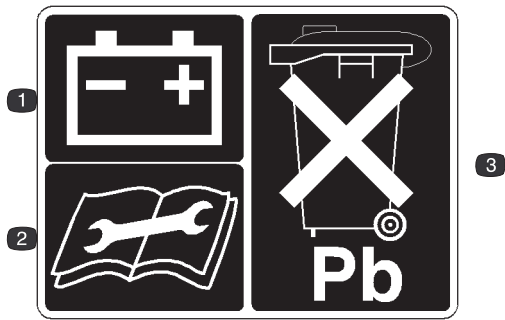

93-6668

1. Battery
2. Read the instructions before servicing or performing maintenance.
3. Contains lead; do not discard.



93-7276

1. Explosion hazard—wear eye protection.
2. Caustic liquid/chemical burn hazard—to perform first aid, flush with water.
3. Fire hazard—no fire, open flames, or smoking.
4. Poison hazard—keep children a safe distance from the battery.



58-6520

1. Grease

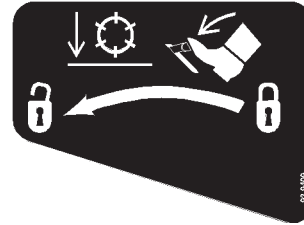

93-9409

1. To unlock the reels before lowering them, press the pedal.

Specifications

Note: Specifications and design subject to change without notice.

General Specifications

Engine	Kubota, four-cycle, four cylinder, 134 cu-in. displacement, water cooled diesel engine. Rated 40 hp @ 2300 rpm, 23:1 compression ratio. Low idle – 1200 rpm, high idle – 2500 rpm. Injection Timing – 17–18 BTDC. Oil capacity is 8 qt. (7.6 L) with filter.
Cooling System	Capacity is 3.7 gal. (14 L) of 50/50 mixture of ethylene glycol anti-freeze.
Fuel System	Capacity is 15 gal. (56.8 L) of #2 diesel fuel.
Hydraulic System	Reservoir capacity is 9.3 gal. (35.2 L) and total system capacity is 18.2 gal. (69 L). Replaceable breather element. Replaceable spin-on filter element.
Traction System	Ground speed is 0–12.5 mph (0–20 km/h).
Cutting Unit Drive System	Adjustable reel speed to match clip to ground speed. Backlap reel speed is 385 rpm.
Seat	Adjusts 6 in. (15.2 cm) forward and backward. Adjustable backrest and three-positions for operator weight. Integral seat switch at rear of bottom seat cushion.
Diagnostic System	Test ports for traction system, cutting unit drive system, lift/counterbalance, lift/relief, steering circuits and charge pressure are located near individual components.
Steering System	Automotive type, full power.
Brakes	Hand brake automatically locks traction linkage in neutral. With traction motor wheel locks engaged, twin disc brakes provide positive, emergency braking.
Electrical System	12 volt, 66 amp hour (DIN) battery and 40 amp alternator. Negative ground.
Interlock System	Designed to stop engine if operator gets off seat while cutting unit drive lever is either in forward or reverse. Prevents engine from starting unless parking brake is engaged, traction pedal is in neutral and cutting units are disengaged. Low hydraulic oil level and high engine temperature protection systems stop engine from running.
Warning Systems	Water in fuel, hydraulic oil filter, engine coolant temperature, engine oil pressure, voltage indicator, air cleaner clogged, hydraulic oil temperature and hydraulic oil level.
Ground Clearance	Approx. 7 in. (17.8 cm)
Height of cut	5 Blade Cutting Unit: 1 – 3 in. (25 – 76 mm) 7 Blade Cutting Unit: 3/8 – 1 3/4 in. (9.5 – 45 mm) 11 Blade Cutting Unit: 3/8 – 3/4 in. (9.5 – 19 mm)
Wheel Thread	53 in. (135 cm)
Wheel Base	57 in. (145 cm)
Operating Circle	60 in. (152 cm)
Reel Speed	800 – 1000 rpm Note: 1200 rpm is attainable with a special coupler.
Clip	5 Blade Cutting Unit: .176 in. per mph (.352 in. at 2 mph – 1.32 in. at 7.5 mph) 7 Blade Cutting Unit: .126 in. per mph (.252 in. at 2 mph – .945 in. at 7.5 mph) 11 Blade Cutting Unit: .080 in. per mph (.16 in. at 2 mph – .600 in. at 7.5 mph)

Measurements

Width-of-cut	
5 Cutting Units	137 in. (348 cm)
4 Cutting Units	110 in. (279 cm)
3 Cutting Units	83 in. (211 cm)
1 Cutting Unit	29 1/2 in. (75 cm)
Overall Width	
Cutting Units Raised	91 1/2 in. (232 cm)
Cutting Units Down	147 in. (373 cm)
Overall Length	110 in. (282 cm)
Height	
w/o ROPS	55 1/2 in. (141 cm)
w/ ROPS	82 in. (208 cm)
Dry Weight	4360 lbs. (1717 kg)

Optional Equipment

5 Blade L. H. Cutting Unit	Model No. 03752 (2 per machine)
5 Blade R. H. Cutting Unit	Model No. 03753 (3 per machine)
7 Blade L. H. Cutting Unit	Model No. 03754 (2 per machine)
7 Blade R. H. Cutting Unit	Model No. 03756 (3 per machine)
11 Blade L. H. Cutting Unit	Model No. 03741 (2 per machine)
11 Blade R. H. Cutting Unit,	Model No. 03751 (3 per machine)
L. H. Dethatcher Kit	Model No. 03730 (2 per machine)
R. H. Dethatcher Kit	Model No. 03732 (3 per machine)
Cutting Unit Fixed Head Kit	Model 03762 (1 per machine)
Cutting Unit Flootation Kit	Model No. 03760 (1 per machine)
Front Roller Kit	Model No. 03742 (1 per machine)
Wiehle Roller Kit	Model No. 03740 (1 per machine)
Rear Roller Scraper Kit	Part No. 59-6090 (1 per cutting unit)
Front Roller Scraper Kit	Part No. 62-6220 (1 per cutting unit)
Side Skid Kit	Model No. 03744 (1 per machine)
Spark Arrester Muffler Kit	Part No. 74-2900 (2 wheel drive only)
Spark Arrester Muffler Kit	Part No. 92-6074 (4 wheel drive only)
R.O.P.S. Kit	Part No. 92-9286 (Standard on 4 wheel drive machines)

Before Operating

Note: Determine the left and right sides of the machine from the normal operating position.

Checking the Engine Oil

Crankcase capacity is 8 qt. (7.6 L) with filter.

1. Park machine on a level surface. Release engine cover latches (Fig. 2).

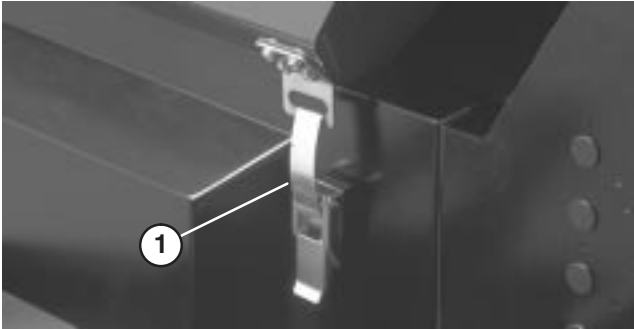

Figure 2

1. Engine cover latch

2. Open engine cover.
3. Remove dipstick, wipe clean and reinstall dipstick into tube and pull it out again: Oil level should be up to FULL mark (Fig. 3).

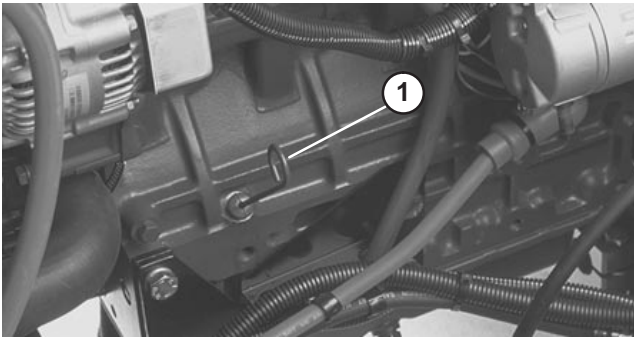

Figure 3

1. Dipstick

4. If oil is below FULL mark, remove fill cap (Fig. 4) and add oil until level reaches FULL mark. DO NOT OVERFILL.

5. The engine uses any high-quality detergent oil having the American Petroleum Institute — API — “service classification” CD, CE, CF, CF-4 or CG-4. Use the following chart to select the proper viscosity grade for the temperature expected.

above 77°F (25° C)	SAE 30, SAE 10W-30 or 10W-40
32° to 77°F (0 to 25° C)	SAE 20, SAE 10W-30 or 10W-40
below 32°F (0° C)	SAE 10W, SAE 10W-30 or 10W-40

Note: When using different oil, drain all old oil from crankcase before adding new oil.

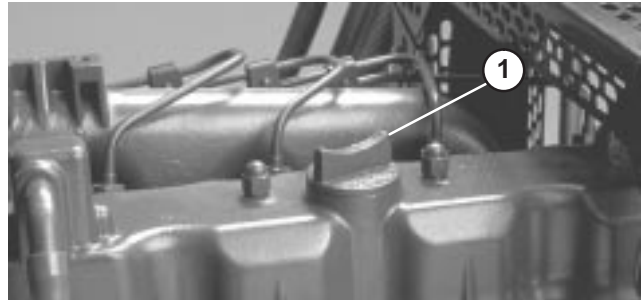

Figure 4

1. Oil fill cap

6. Install oil fill cap and dipstick.
7. Close engine cover and secure with the latches.

Check Cooling System

Check level of coolant at the beginning of each day.

Capacity of system is 3.7 gal. (14 L).

1. Carefully remove radiator cap (Fig. 6) and expansion tank cap (Fig. 5).



Caution



If the engine has been running, pressurized hot coolant can escape and cause burns if the radiator cap is removed.

Allow the engine to cool at least 15 minutes or until the radiator cap is cool enough to touch without burning hands.

2. Check level of coolant in radiator. Radiator should be filled to the top of the filler neck and the expansion tank filled to the marks on its side

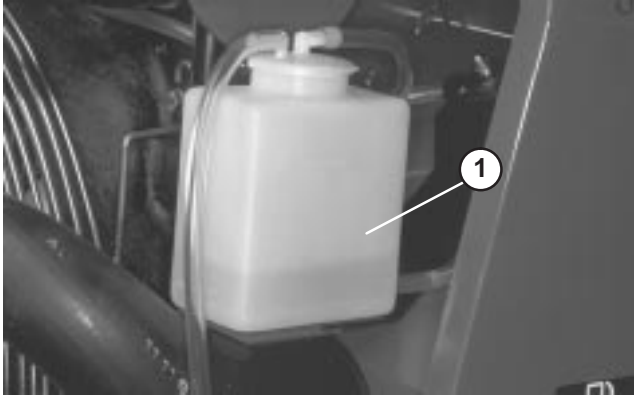

Figure 5

1. Expansion tank

3. If coolant is low, add a 50/50 mixture of water and ethylene glycol anti-freeze. **DO NOT USE WATER ONLY OR ALCOHOL / METHANOL BASE COOLANTS.**
4. Install radiator cap and expansion tank cap.

Fill Fuel Tank

1. Remove fuel tank cap (Fig. 6).
2. Fill tank to about one inch (25 mm) below bottom of filler neck with No. 2 diesel fuel. Then install cap.

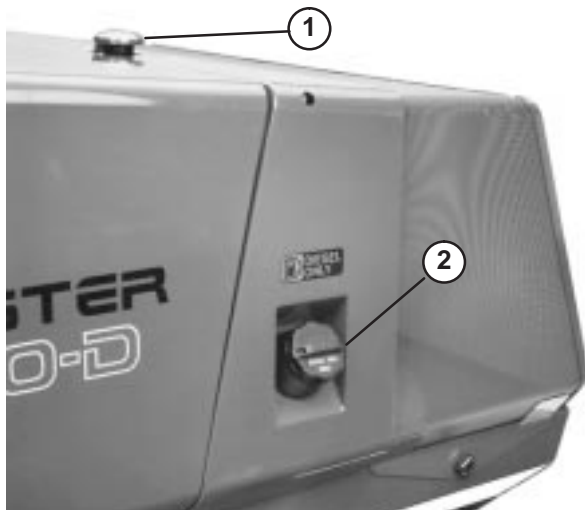

Figure 6

1. Radiator cap
2. Fuel tank cap

⚠
Danger
⚠

Under certain conditions, diesel fuel and fuel vapors are highly flammable and explosive. A fire or explosion from fuel can burn you and others and can cause property damage.

- Use a funnel and fill the fuel tank outdoors, in an open area, when the engine is off and is cold. Wipe up any fuel that spills.
- Do not fill the fuel tank completely full. Add fuel to the fuel tank until the level is 1 in. (25 mm) below the bottom of the filler neck. This empty space in the tank allows the fuel to expand.
- Never smoke when handling fuel, and stay away from an open flame or where fuel fumes may be ignited by a spark.
- Store fuel in a clean, safety-approved container and keep the cap in place.

Checking the Hydraulic Fluid

The machines hydraulic system is filled at the factory with approximately 18.2 gallons of high quality hydraulic fluid. **Check the level of hydraulic fluid before the engine is first started and daily thereafter.** Appropriate hydraulic oils are listed below.

The following list is not assumed to be all-inclusive. Hydraulic fluids produced by other manufacturers may be used if they cross find a cross reference equivalent to the products listed. Toro will not assume responsibility for damage caused by improper substitutions, so use only products from reputable manufacturers who will stand behind their recommendation.

Multigrade Hydraulic Fluid – ISO VG 68

Mobil	DTE 26
Amoco	Rykon AW No. 68
Chevron	Hydraulic Oil AW ISO 68
Conoco	Hydroclear AW 68
Exxon	Nutto H 68
Pennzoil	AW Hydraulic Oil 68
Shell	Tellus 68
Texaco	Rando HD 68

Note: Many hydraulic fluids are almost colorless, making it difficult to spot leaks. A red dye additive for the hydraulic system oil is available in 2/3 oz. (20 ml) bottles. One bottle is sufficient for 4–6 gal (15–22 l) of hydraulic oil. Order part no. 44–2500 from your authorized Toro distributor.

1. Park machine on a level surface.

2. Look into sight glass (Fig. 7). Oil level should be even with arrows when checking warm oil. Oil will be 1/4 to 1/2 inch below arrows when cold.
3. If oil level is low, add hydraulic oil to the reservoir.



Figure 7

1. Sight glass arrows

Check Reel To Bedknife Contact

Each day before operating, check reel to bedknife contact, regardless if quality of cut had previously been acceptable. There must be light contact across the full length of the reel and bedknife (refer to Adjusting Cutting Units in Cutting Unit Manual, Step #1 – Reel to Bedknife Adjustment).

Check Tire Pressure

For normal mowing conditions and a wide variety of turf grasses, use these tire pressures: 13 psi front and 15 psi rear. However, when turf is either wetter or drier than normal, tire pressure may need to be changed. On hard turf, use high tire pressure (18 psi front and rear). When turf is soft, use low pressure (9 psi front and 12 psi rear).

Important Maintain even pressure in two front tires (ie. 13 psi) and both rear tires (ie 15 psi) to assure excellent quality-of-cut. Do not exceed 10 mph transport speed (for extended periods) when tire pressure is 12 psi or less because tires may be damaged. Maximum transport speed can be used when front tire pressure is 13 psi or more.

Rear Ballast

This unit complies with the ANSI B71.4–1990 Standard when rear tires are filled with calcium chloride and a rear wheel weight kit (Part No. 11–0440) is installed.

Important If a puncture occurs in a tire with calcium chloride, remove unit from turf area as quickly as possible. To prevent possible damage to turf, immediately soak affected area with water.

Operation

Note: Determine the left and right sides of the machine from the normal operating position.

Controls

Seat Adjusting Lever

The seat adjusting lever (Fig. 8) allows 5.9 inch (15 cm) fore and aft adjustment in 19/32 inch (15 mm) increments.



Figure 8

1. Seat adjusting lever

Arm Rest

Pivot the arm rest (Fig. 9) up and down for operator comfort.

Backrest Knob

The backrest knob (Fig. 9) adjusts backrest angle from 5–20 degrees.

Suspension Lever

The suspension lever (Fig. 9) adjusts seat to the operator's weight. Use up position for light weight operators, center position for medium weight operators and down for heavier weight operators.

Note: Backrest and bottom seat cushions are removable.

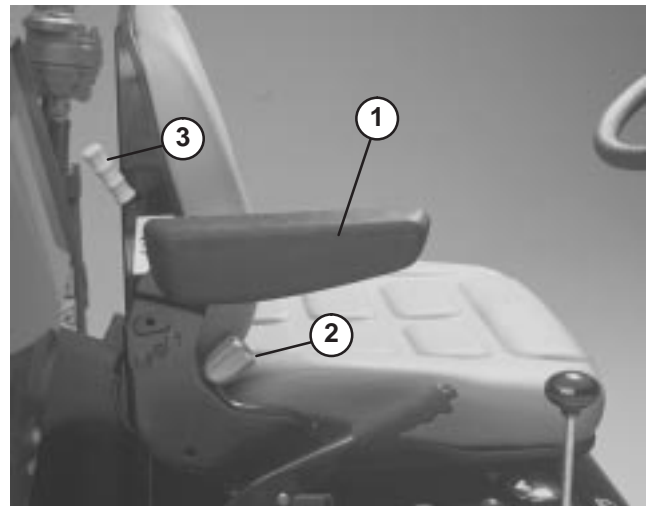

Figure 9

1. Arm rest
2. Backrest knob
3. Suspension lever



Caution



To assure interlock switch operates properly, seat suspension must be set for the weight of each operator. If suspension is not set correctly, the engine will run intermittently and tend to stall. To correct this, set suspension lighter.

Warning Light Test Button

Before operating machine, press warning light test button (Fig. 10). All lights on the steering tower should illuminate. Any light that does not come on indicates an electrical malfunction that should be repaired immediately. Oil pressure and electrical no charge indicator lights illuminate when turning key switch "ON".

Hydraulic and Engine Indicator Lights

If these lights come on (Fig. 10), stop machine and make repairs immediately.

Engine Oil Pressure Warning

Dangerously low engine oil pressure is indicated by both a warning indicator light and audible signal (Fig. 10). When this occurs, stop the engine immediately and correct problem.

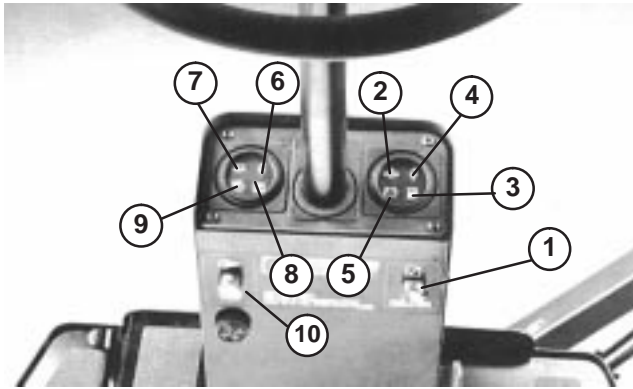

Figure 10

- | | |
|--------------------------------------|--------------------------------------|
| 1. Warning light check switch | 6. Hydraulic oil temperature warning |
| 2. Engine oil pressure warning light | 7. Hydraulic oil level warning |
| 3. Fuel system warning | 8. Hydraulic oil filter warning |
| 4. Coolant temperature warning | 9. Air cleaner warning |
| 5. Electrical no charge warning | 10. Alarm silence warning |

Fuel System Warning

A warning indicator light and audible signal (Fig. 10) warn of excess water in fuel system. Remove water from system.

Coolant Temperature Warning

If engine coolant temperature exceeds 221° F (105° C) a warning indicator light (Fig. 10) illuminates and audible signal sounds. The engine shuts down if temperature of coolant exceeds 230° F (110° C). Switch resets automatically when system and engine cools down.

Electrical No Charge Warning

No charge to the batteries is indicated by a warning indicator light and audible signal (Fig. 10).

Hydraulic Oil Temperature Warning

A warning indicator light and audible signal warn (Fig. 10) of excessively high hydraulic temperature.

Hydraulic Oil Level Warning

A warning indicator light and audible signal (Fig. 10) warn of low hydraulic oil level. If oil level drops further, the engine will automatically be stopped. Engine cannot be restarted until oil supply is brought to a safe level.

Hydraulic Oil Filter Warning

A warning indicator light and audible signal (Fig. 10) warn of clogged hydraulic filter.

Air Cleaner Warning

A warning indicator light and audible signal (Fig. 10) warn the filter is clogged and in need of service.

Alarm Silence Button

Pressing button (Fig. 10) silences alarm. Alarm system will disengage and automatically reset when problem is corrected or the alarm silence button is pressed.

Traction Pedal

The traction pedal (Fig. 11) controls forward and reverse operation. Depress top of pedal to move forward and bottom to move backward. Ground speed depends on how far pedal is depressed. For maximum ground speed, fully depress pedal while throttle is in FAST. For maximum power under load or when going uphill, keep engine rpm high by having throttle in FAST and traction pedal held stationary against ground speed limiter. If engine rpm begins to decrease due to load, gradually reduce traction pedal pressure until engine speed is increased.

To stop, reduce foot pressure on traction pedal and allow it to return to center position. On extreme downhill slopes, apply pressure to REVERSE side of pedal, or operate with heel on REVERSE and toe on FORWARD portion of pedal.

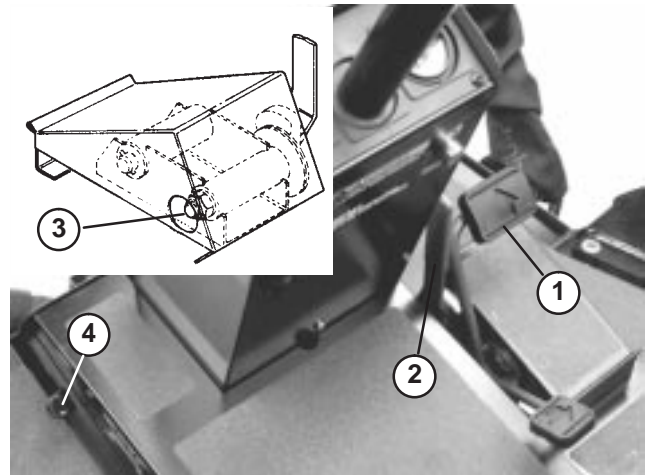

Figure 11

- | | |
|-------------------|--------------------|
| 1. Traction pedal | 3. Cam lever nut |
| 2. Speed limiter | 4. Transport latch |

Ground Speed Limiter

The ground speed limiter (Fig. 11) controls traction pedal movement. Limiter lever helps control the rate of clip and eliminates sudden speed variations over rough terrain.

Important Cam lever nut (Fig. 11, Inset) can be tightened if limiter stop will not hold traction pedal in desired position.

Transport Latches

Latches secure cutting units in upright position for transport operation. Latch for front cutting units is foot-operated (Fig. 11). Hand-operated latches control the center and outside cutting units (Fig. 12).

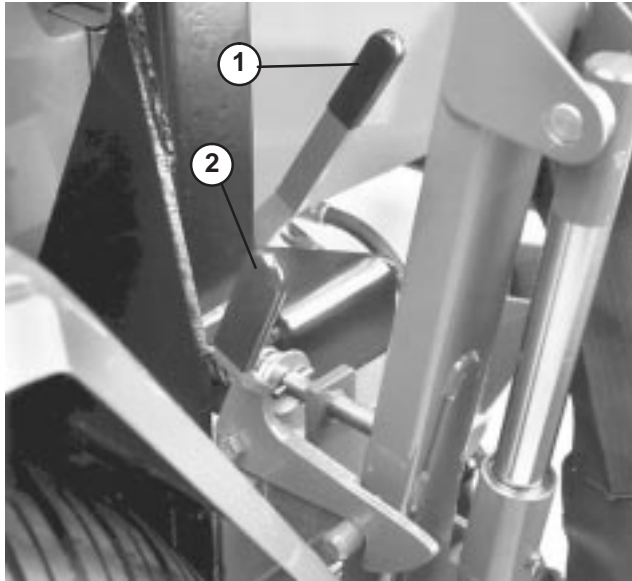

Figure 12

1. Center cutting unit latch 2. Outside cutting unit latch

Cutting Unit Lift Controls

The two outside levers (Fig. 13) raise and lower the two outside cutting units. The center lever raises and lowers the two front and the center cutting units. Engine must be running to lower cutting units. When cutting units are lifted, reels automatically stop. Do not allow levers to snap-back to neutral, or cutting units may not float freely.

Engine Override Button

When button (Fig. 13) is depressed, engine can be operated after it has over heated and automatically been stopped by the electrical safety system. Use only for short intervals.

Fuel Level Gauge

Gauge (Fig. 13) indicates amount of fuel in tank.

Hour Meter

Hour meter (Fig. 13) indicates total hours that machine has been operated.

Note: Lines circling in the small window at left side of gauge indicate hour meter is operating.

Engine Preheat Indicator Light

Light (Fig. 13) turns on when key is moved to ON position. Glow plugs engage for 10 seconds, then, light goes off when engine is ready to start.

Key Switch

Three positions: OFF, ON and START. Rotate key (Fig. 13) to START and release key when engine begins running. To stop engine, rotate key to OFF.

Parking Brake Lever

Pull lever (Fig. 13) up to lock brake. To release brake, pull up on lever, press button and lower lever. Brake must be engaged to start engine. Always engage parking brake before getting off seat.

Mow-Backlap Lever

Move lever (Fig. 13) forward to engage cutting units. Move lever to the center to stop the cutting units. To backlap cutting units, lift lever over stop and hold in the rear position.

Important Do not move lever directly between MOW and BACKLAP positions. Pause briefly in STOP position.

Reel Speed Control

Rotate knob (Fig. 13) clockwise to increase reel speed, counter-clockwise to decrease speed. Use in conjunction with the ground speed limiter to achieve appropriate rate of clip.

Throttle Control

Move control (Fig. 13) forward to increase engine speed, backward to decrease speed.

4 Wheel Drive Switch

Move switch (Fig. 13) forward to engage 4 wheel drive. Move switch to rear position to disengage 4 wheel drive. (4 wheel drive model only)

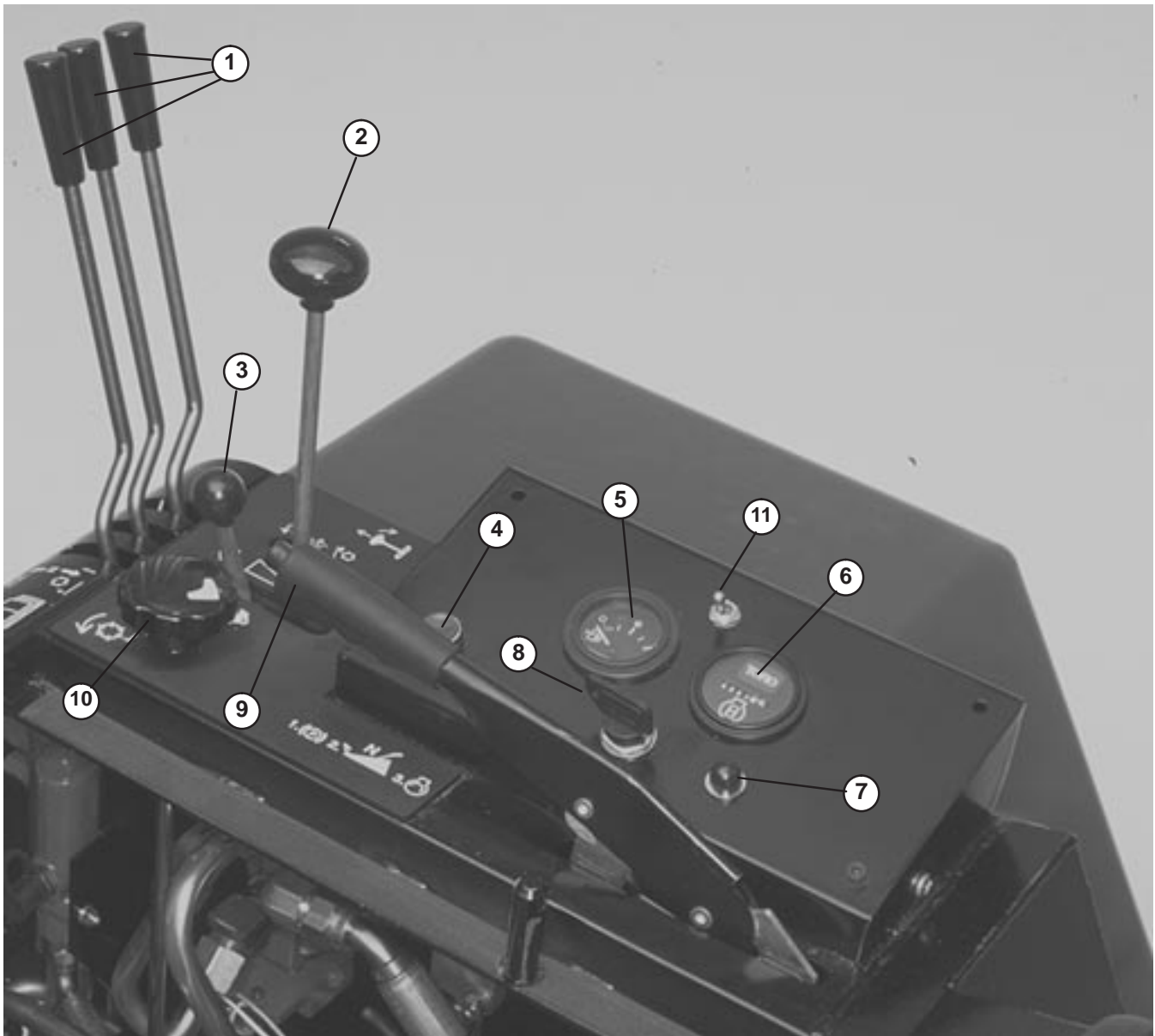

Figure 13

- | | | | |
|-------------------------------|---------------------------|-----------------------------------|---|
| 1. Cutting unit lift controls | 4. Engine override button | 7. Engine preheat indicator light | 10. Reel speed control |
| 2. Mow/backlap lever | 5. Fuel gauge | 8. Key switch | 11. 4 Wheel drive switch (4 wheel drive only) |
| 3. Throttle | 6. Hour meter | 9. Hand brake | |

Starting And Stopping

1. Sit on the seat, keep foot off traction pedal. Assure parking brake is engaged (Fig. 13). Traction pedal and mow/backlap lever must be in neutral.
2. Turn key switch to ON position. When glow plug indicator light goes off, engine is ready to START.
3. Turn key to START. Release key when engine starts.
4. To stop, disengage and move all controls to neutral and set parking brake. Raise and latch all cutting units in transport position. Turn key to OFF and remove it from switch.

Bleeding Fuel System

1. Park the machine on a level surface. Make sure fuel tank is at least half full.
2. Raise engine cover.
3. Open vent plug on the fuel filter/water separator (Fig. 14).

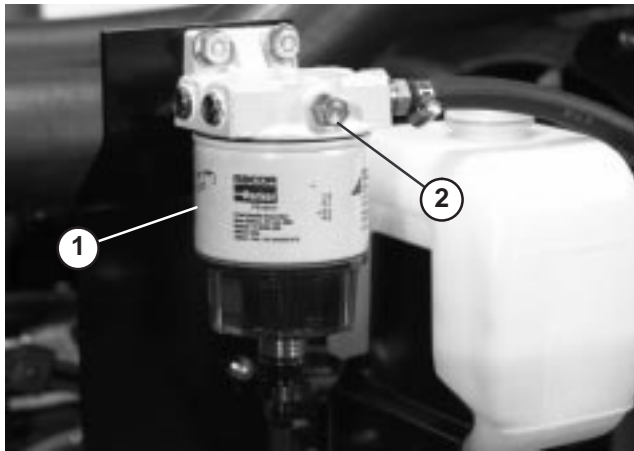

Figure 14

1. Fuel filter/water separator
2. Vent plug

4. Turn key in ignition switch to the ON position. Electric fuel pump will begin operation, thereby forcing air out around vent plug. Leave key in ON position until a solid stream of fuel flows out around plug. Tighten plug and turn key to OFF.
5. Open the air bleed screw on the fuel injection pump (Fig. 15).

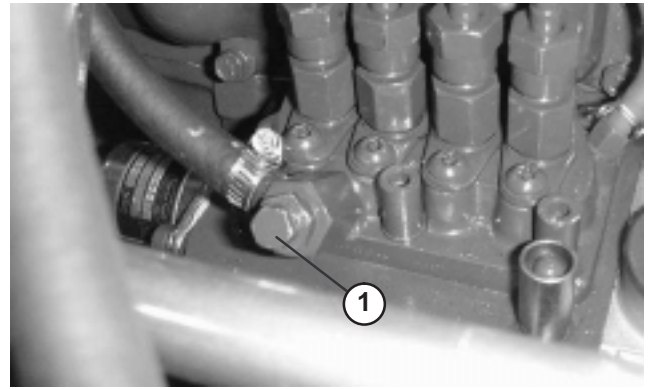

Figure 15

1. Fuel injection pump bleed screw

6. Turn key in ignition switch to the ON position. Electric fuel pump will begin operation, thereby forcing air out around air bleed screw. Leave key in ON position until a solid stream of fuel flows out around screw. Tighten screw and turn key to OFF.

Note: Normally, engine should start after above bleeding procedures are followed. However, if engine does not start, air may be trapped between injection pump and injectors; refer to Bleeding Air From Injectors.

Checking Warning Indicator Lights

Each day before operating, assure all warning lights are working.

Note: Alarm will continue to sound until problem is corrected or until alarm silence button is pressed. If a second problem is encountered, the alarm will not sound but indicator light will illuminate.

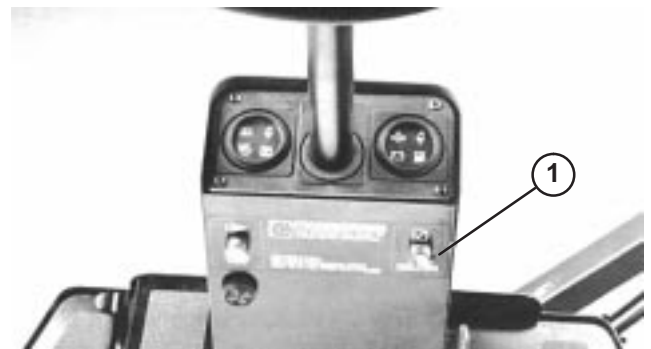

Figure 16

1. Warning indicator light test button

Checking Interlock System.



Caution



If safety interlock switches are disconnected or damaged the machine could operate unexpectedly causing personal injury.

- Do not tamper with the interlock switches.
- Check the operation of the interlock switches daily and replace any damaged switches before operating the machine.
- Replace switches every two years regardless of whether they are operating properly or not.

1. In a wide open area free of debris and bystanders, lower cutting units to the ground. Stop engine.
 2. Sit on the seat and engage parking brake (Fig. 13). Turn key and try to start engine with Mow–Backlap lever (Fig. 13) in both the MOW and BACKLAP positions. If engine cranks, there is a malfunction that must be repaired immediately. If engine does not crank, the cutting unit drive switch is operating properly.
 3. Sit on the seat and disengage the parking brake. Turn key and try to start engine with Mow–Backlap lever in STOP. If engine cranks, there is a malfunction that must be repaired immediately. If engine does not crank, brake switch is operating properly.
 4. Engage parking brake, start engine and lower cutting units. Move Mow–Backlap lever to MOW. Raise off the seat; engine should stop within a few seconds, which indicates the interlock system is operating. Also raise off the seat with lever in BACKLAP. Engine should stop, indicating interlock system is operating. If engine does not stop, there is a malfunction that must be repaired immediately.
- Note:** There is a 1 – 2 second delay between rising off seat and engine shut off.
5. Engage parking brake, move Mow–Backlap lever to NEUTRAL, start engine, disengage hand brake and raise off seat. If engine stops, interlock system is operating. If engine does not stop, there is a malfunction that must be repaired immediately.

Pushing Or Towing Traction Unit

In an emergency, the traction unit can be pushed or towed for a very short distance, by using the traction pump by-pass valve.

Important Do not push or tow the traction unit faster than 2 to 3 MPH (3 to 5 Km/Hr) because hydraulic system may be damaged. If traction unit must be moved a considerable distance, transport it on a truck or trailer.

1. Remove retainer clip from seat lock rod (Fig. 17).

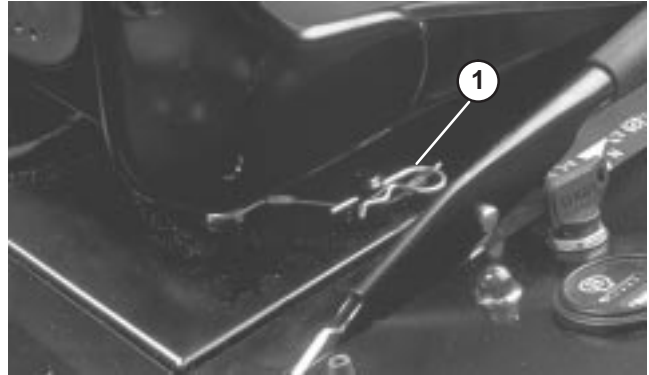

Figure 17

1. Retainer clip

2. Raise seat and support it in upright position with seat support rod (Fig. 18).

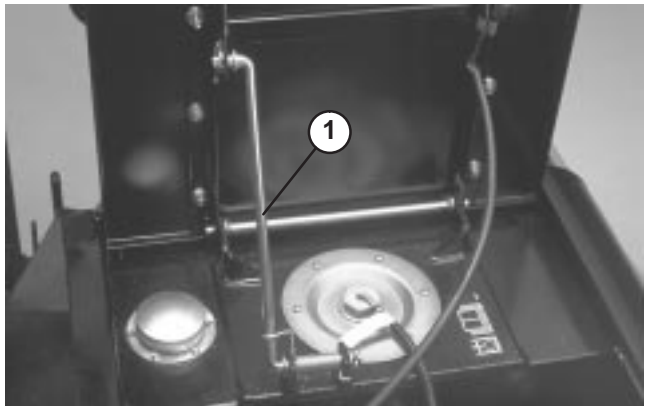

Figure 18

1. Seat support rod

3. Rotate by-pass valve 90 degrees (Fig. 19). Opening the valve opens an internal passage in the traction pump, thereby by-passing hydraulic oil. Because oil is by-passed, traction unit can be moved without damaging the hydraulic system.

Mow-Backlap lever to MOW. Reels are now spinning. Maintain traction pedal contact with ground speed limiter (Fig. 21) to assure consistent clip and quality-of-cut.

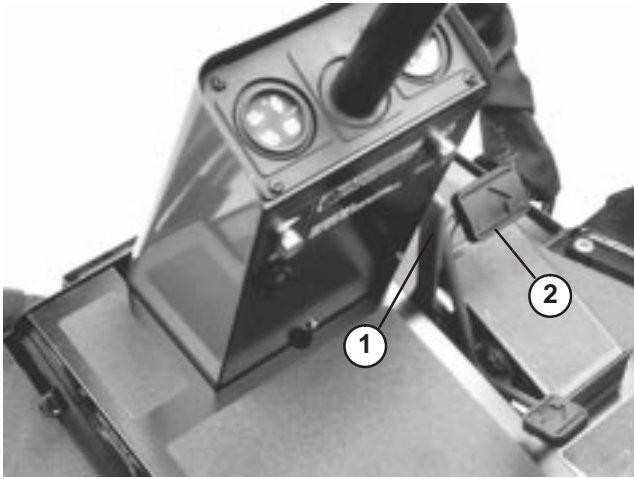

Figure 21

1. Ground speed limiter 2. Traction pedal

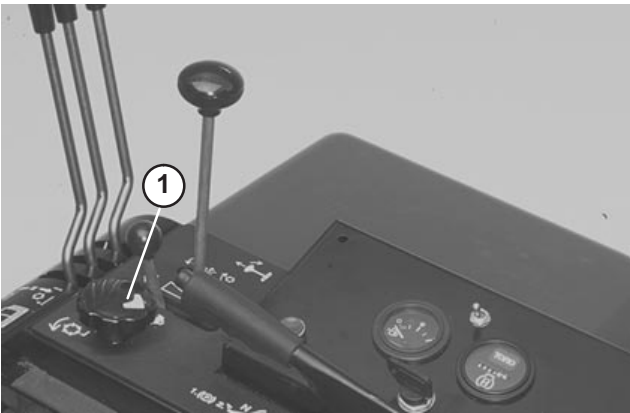

Figure 22

1. Reel speed control

CAUTION: This product may exceed noise levels of 85 dB(A) at the operator position. Ear protectors are recommended for prolonged exposure to reduce the potential of permanent hearing damage.

Transport

When mowing is complete, move MOW-BACKLAP lever to STOP. Raise cutting units by pulling back on lift control levers. Hold levers back until cutting units are fully raised (a squeal from the hydraulic system means cutting units are fully raised). Lock cutting units in place with transport latches. Be careful when driving between objects so you do not accidentally damage the machine or cutting units.

Matching Ground Speed and Reel Speed

Vary reel speed (while maintaining constant ground speed) to establish the best quality of cut for the area being mowed. Reel speeds either too fast or too slow for conditions may effect the quality of cut. Use the cutting chart (Fig. 23) and decal on steering console as a guide for initial adjustment of ground and reel speeds.

CUTTING CHARTS

Relate HOC and ground speed to required reel speed setting on a 1 thru 5 scale on reel speed knob.
 Note: 1 = 800 RPM; 2 = 900 RPM; 3 = 1000 RPM; 4 = 1100 RPM and 5 = 1200 RPM.

* Speeds are approximate

Recommended Reel Speed Settings

5 Blade Reel						7 Blade Reel						11 Blade Reel					
HOC	Ground Speed In MPH					HOC	Ground Speed In MPH					HOC	Ground Speed In MPH				
	3	4	5	6	7		3	4	5	6	7		3	4	5	6	7
1	1	3	5	N/R	N/R	1/2	2	5	N/R	N/R	N/R	3/8	1	3	5	N/R	N/R
1.25	N/R	1	3	5	N/R	5/8	1	3	5	N/R	N/R	1/2	N/R	1	3	4	N/R
1.5	N/R	N/R	2	3	4	3/4	N/R	1	3	5	N/R	5/8	N/R	N/R	1	2	4
2	N/R	N/R	N/R	1	2	1	N/R	N/R	1	2	3	3/4	N/R	N/R	N/R	1	2
2.5	N/R	N/R	N/R	N/R	1	1.25	N/R	N/R	N/R	1	2						

Note: N/R = Not Recommended

Note: Positions 4 and 5 are only attainable with a special coupler (Part No. 58-1530). Contact your Toro Dealer for information.

Figure 23

Maintenance

Note: Determine the left and right sides of the machine from the normal operating position.

Recommended Maintenance Schedule

Maintenance Service Interval	Maintenance Procedure
After first 10 hours	<ul style="list-style-type: none"> • Check the fan and alternator belt tension. • Torque the wheel lug nuts.
After first 50 hours	<ul style="list-style-type: none"> • Change the engine oil and filter. • Check the engine RPM (idle and full throttle). • Change the hydraulic filter. • Adjust valves • Change the front planetary gear lube
Every 50 hours	<ul style="list-style-type: none"> • Lubricate all grease fittings. • Check the air cleaner.¹ • Check the battery fluid level and cable connections. • Lubricate reel control valve grease fitting • Lubricate reel speed valve with oil
Every 100 hours	<ul style="list-style-type: none"> • Change the engine oil and filter. • Drain water from hydraulic tank • Inspect the cooling system hoses. • Check the fan and alternator belt tension.
Every 200 hours	<ul style="list-style-type: none"> • Torque the wheel lug nuts. • Inspect cutting unit reel drive belts
Every 400 hours	<ul style="list-style-type: none"> • Service the air cleaner.¹ • Replace the fuel filters. • Check the engine RPM (idle and full throttle). • Inspect fuel lines and connections
Every 800 hours	<ul style="list-style-type: none"> • Drain and clean fuel tank • Change the hydraulic filter • Change hydraulic tank breather • Check rear wheel toe-in. • Pack the 2WD rear wheel bearings. • Change the front planetary gear lube • Adjust valves
Every 1600 hours or every 2 years, whichever occurs first	<ul style="list-style-type: none"> • Replace all moving hoses. • Replace interlock safety switches. • Flush/replace the cooling system fluid. • Drain/flush hydraulic tank.

¹Service air cleaner whenever indicator shows red

Important Refer to your engine operator’s manual for additional maintenance procedures.



Caution



If you leave the key in the ignition switch, someone could accidentally start the engine and seriously injure you or other bystanders.

Remove the key from the ignition and disconnect the wire from the spark plug before you do any maintenance. Set the wire aside so that it does not accidentally contact the spark plug.

Daily Maintenance Checklist

Duplicate this page for routine use.

Maintenance Check Item	For the week of:						
	Mon.	Tues.	Wed.	Thurs.	Fri.	Sat.	Sun.
Check safety interlock operation.							
Check brake operation.							
Check engine oil and fuel level.							
Check cooling system fluid level.							
Drain the water/fuel separator.							
Check the air filter restriction indicator.							
Check the radiator, oil cooler and screen for debris.							
Clean traction pedal lockout							
Check unusual engine noises. ¹							
Check unusual operating noises.							
Check the hydraulic system oil level.							
Check the hydraulic hoses for damage.							
Check for fluid leaks.							
Check the tire pressure.							
Check instrument operation.							
Check Warning lamps operation							
Check the reel-to-bedknife adjustment.							
Check the height-of-cut adjustment.							
Lubricate all grease fittings. ²							
Touch up damaged paint.							

¹Check the glow plug and injector nozzles, if hard starting, excess smoke, or rough running is noted.

²Immediately after **every** washing, regardless of the interval listed.

Lubrication

The machine has grease fittings that must be lubricated after every 50 hours of operation with No. 2 General Purpose Lithium Base Grease. Lubricate fitting immediately after every washing regardless of interval listed. The lubrication points are: lift arms (5) (Fig. 24), rear axle (6) (Fig. 25), floating or fixed head kit pivots (Fig. 26) and cutting unit reel and roller bearings (Fig. 27). Also, grease fitting on reel control valve (not shown), located under right hand console.

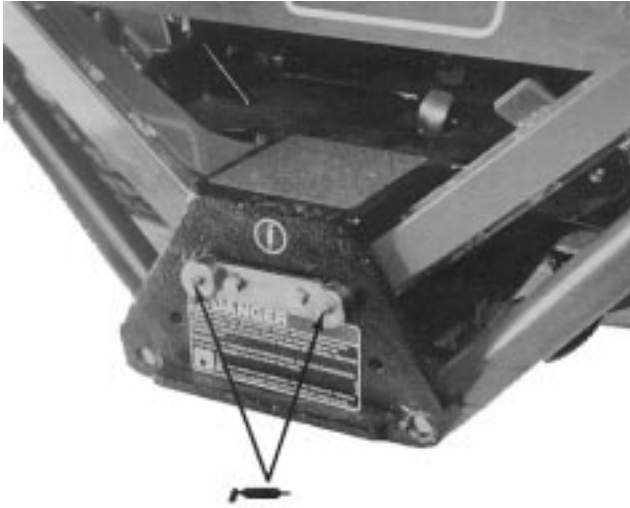

Figure 24

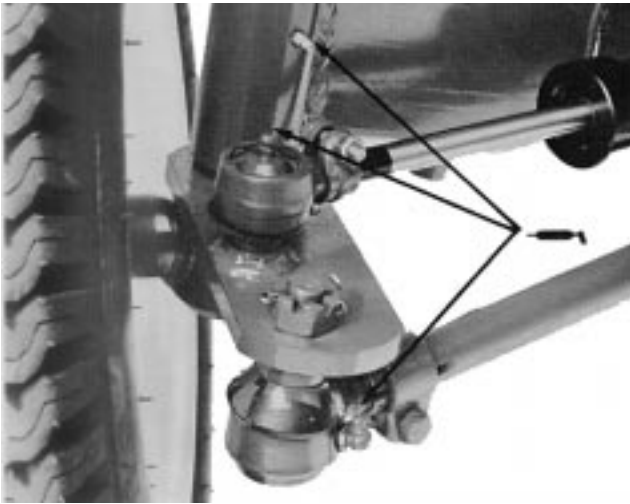

Figure 25

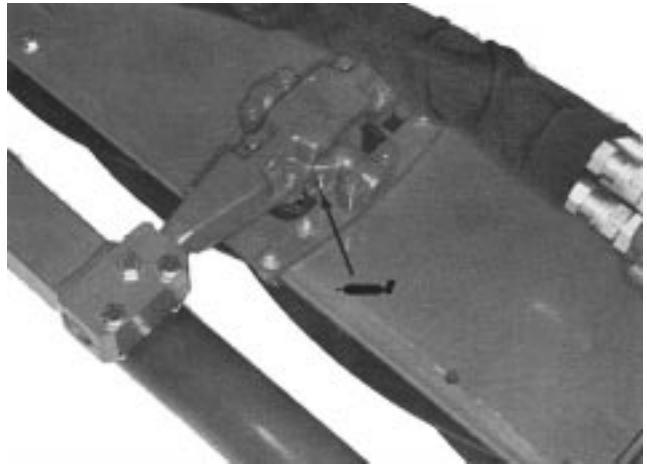

Figure 26

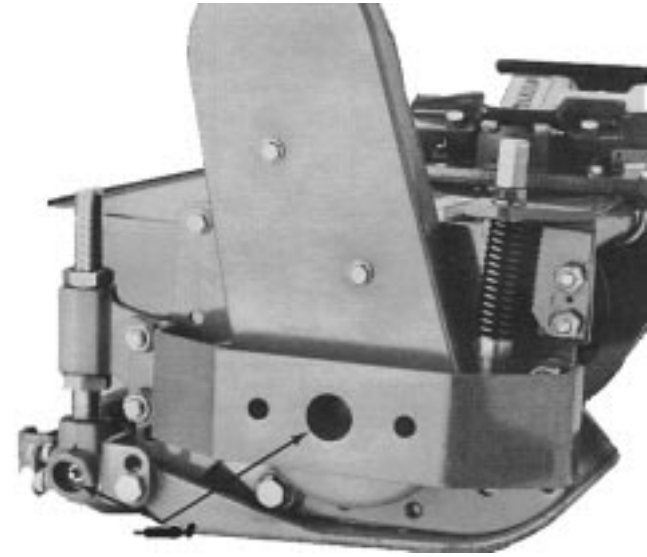

Figure 27

Note: Remove the plastic caps over the fittings on the floating or fixed head kit pivots and replace after greasing (Fig. 26).

General Air Cleaner Maintenance

Check air cleaner body for damage which could possibly cause an air leak. Replace a damaged air cleaner body.

Service the air cleaner filters when ever air cleaner indicator light illuminates and warning signal sounds or every 400 hours (more frequently in extreme dusty or dirty conditions). Do not over service air filter.

Be sure cover is sealing around air cleaner body.

Servicing Air Cleaner

1. Remove knobs securing rear screen to frame (Fig. 28). Remove screen.

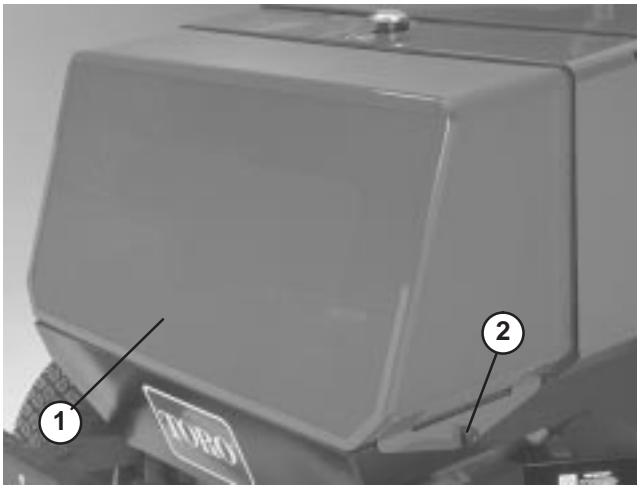

Figure 28

1. Rear screen
2. Knob

2. Release latches securing air cleaner cover to air cleaner body. Separate cover from body. Clean inside of air cleaner cover.
3. Gently slide primary filter out of air cleaner body to reduce the amount of dust dislodged. Avoid knocking filter against air cleaner body. **Do not remove safety filter.**
4. Inspect primary filter and discard if damaged. Do not wash or reuse a damaged filter.

Important Never attempt to clean a safety filter (Located inside primary filter). Replace the safety filter with a new one after every three primary filter services.

5. Blow compressed air from inside to the outside of dry filter element. Do not exceed 100 psi to prevent damage to the element.

6. Keep air hose nozzle at least 2” from filter and move nozzle up and down while rotating the filter element. Inspect for holes and tears by looking through the filter toward a bright light.

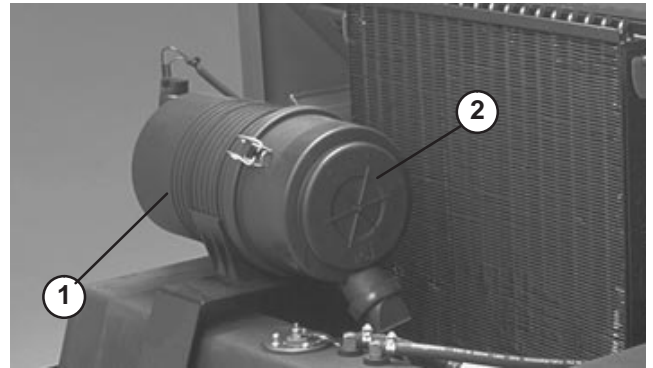

Figure 29

1. Air cleaner body
2. Air cleaner cover

7. Inspect new filter for shipping damage. Check sealing end of filter. Do not install a damaged filter.
8. Insert new filter properly into air cleaner body. Make sure filter is sealed properly by applying pressure to outer rim of filter when installing. Do not press on flexible center of filter.
9. Reinstall cover and secure latches. Make sure cover is positioned with TOP side up.

Engine Oil And Filter

Change oil and filter after the first 50 hours of operation and every 100 hours thereafter.

1. Remove drain plug (Fig. 30) and let oil flow into drain pan. When oil stops, install drain plug.

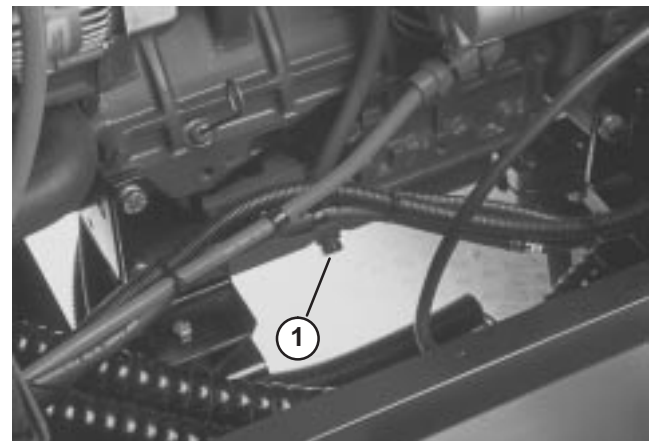

Figure 30

1. Drain plug

- Remove oil filter (Fig. 31). Apply a light coat of clean oil to the new filter seal before screwing it on. **DO NOT OVER-TIGHTEN.**
- Add oil to crankcase. Refer to Check Engine Oil.

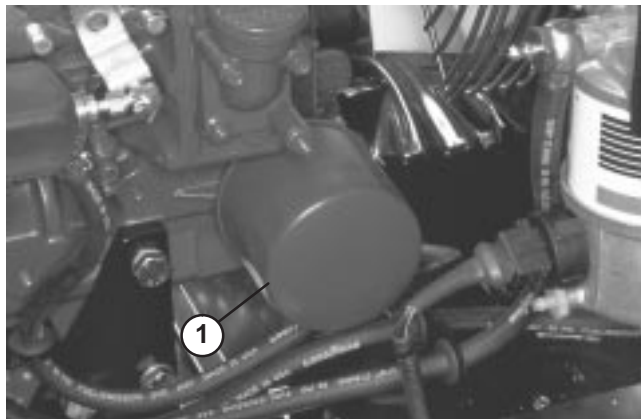

Figure 31

- Oil filter

Fuel System

Fuel Tank

Drain and clean fuel tank every 800 hours of operation or yearly, whichever comes first. Also, drain and clean tank if fuel system becomes contaminated or if machine is to be stored for an extended period. Use clean fuel to flush out the tank.



Danger



Under certain conditions, diesel fuel and fuel vapors are highly flammable and explosive. A fire or explosion from fuel can burn you and others and can cause property damage.

- Use a funnel and fill the fuel tank outdoors, in an open area, when the engine is off and is cold. Wipe up any fuel that spills.
- Do not fill the fuel tank completely full. Add fuel to the fuel tank until the level is 1/4 to 1/2 in. (6 to 13 mm) below the bottom of the filler neck. This empty space in the tank allows the fuel to expand.
- Never smoke when handling fuel, and stay away from an open flame or where fuel fumes may be ignited by a spark.
- Store fuel in a clean, safety-approved container and keep the cap in place.

Fuel Lines and Connections

Check lines and connections every 400 hours or yearly, whichever comes first. Inspect for deterioration, damage, or loose connections.

Fuel Filter / Water Separator

Drain water or other contaminants from fuel filter / water separator (Fig. 32) daily.

- Locate fuel filter and place a clean container under it.
- Loosen drain plug on bottom of filter canister. Tighten plug after draining.

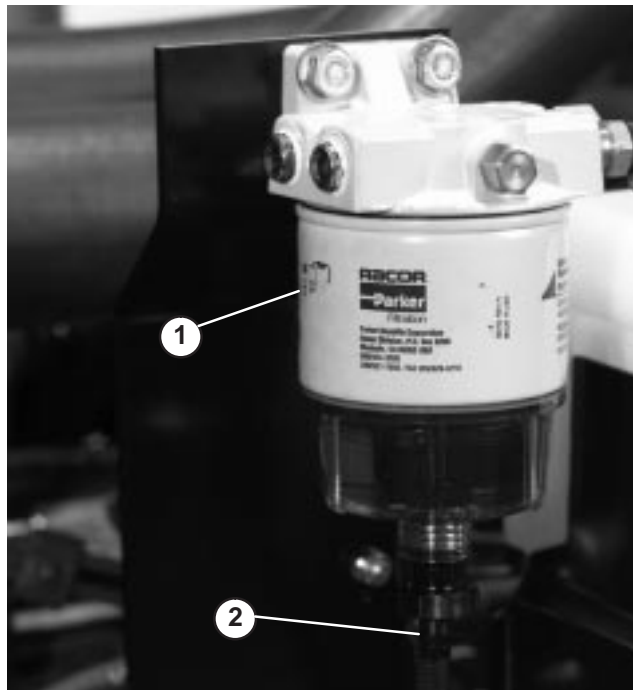

Figure 32

- Fuel filter/water separator
- Drain plug

Replace filter canister after every 400 hours of operation.

- Clean area where filter canister mounts.
- Remove filter canister and clean mounting surface.
- Lubricate gasket on filter canister with clean oil.
- Install filter canister by hand until gasket contacts mounting surface, then rotate an additional 1/2 turn.

Replacing Fuel Filter

(Machines with serial numbers prior to 230000001)

Replace the fuel filter after every 400 operating hours or yearly, whichever occurs first.

- Clean area where filter bowl mounts.

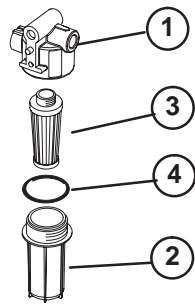

Figure 33

- | | |
|------------------------------|-----------|
| 1. Fuel filter mounting head | 3. Filter |
| 2. Filter bowl | 4. O-ring |

2. Remove the filter bowl and clean mounting surface.
3. Remove filter from bowl and replace with new filter.
4. Install filter bowl by hand until O-ring contacts mounting surface.

Replacing the Fuel Pre-Filter (Machines with serial numbers 230000201 and up)

Replace the fuel pre-filter (Fig. 34), located between fuel the tank and fuel pump, after every 400 operating hours or yearly, whichever occurs first.

1. Clamp both fuel lines that connect to the fuel filter so that fuel cannot drain when the lines are removed.
2. Loosen the hose clamps at both ends of the filter and pull the fuel lines off of the filter.

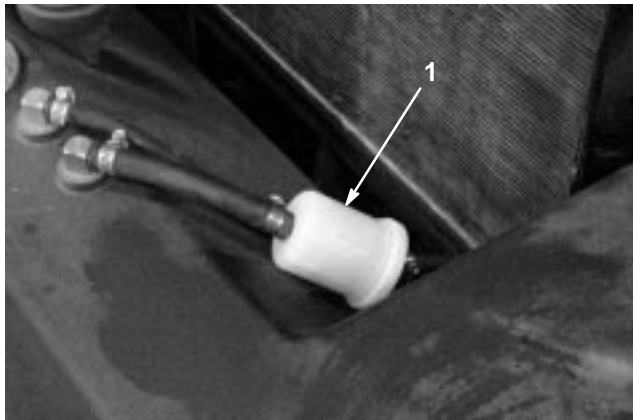

Figure 34

1. Fuel pre-filter

3. Slide the hose clamps onto the ends of the fuel lines. Push the fuel lines onto the fuel filter and secure them with the hose clamps. Be sure that the arrow on the side of the filter points toward the injection pump.

Bleeding Air From Injectors

Note: This procedure should be used only if fuel system has been purged of air through normal priming procedures and engine will not start; refer to Bleeding Fuel System.

1. Loosen the pipe connection to the No. 1 nozzle and holder assembly.

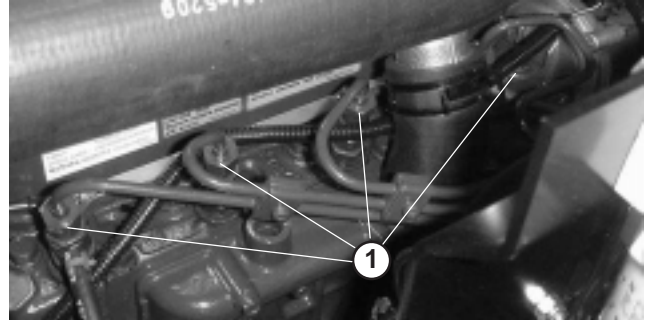

Figure 35

1. Fuel injector (4)

2. Move throttle to FAST position.
3. Turn key in key switch to START position and watch fuel flow around connector. Engine will crank. Turn key to OFF position when solid flow is observed.
4. Tighten pipe connector securely.
5. Repeat steps on remaining nozzles.

Engine Cooling System

Removing Debris

Remove debris from oil cooler, radiator and rear screen daily, clean more frequently in dirty conditions.

1. Turn engine off, release front engine cover latches and raise engine cover. Clean engine area thoroughly of all debris.
2. Remove knobs securing rear screen to frame and remove screen (Fig. 36).

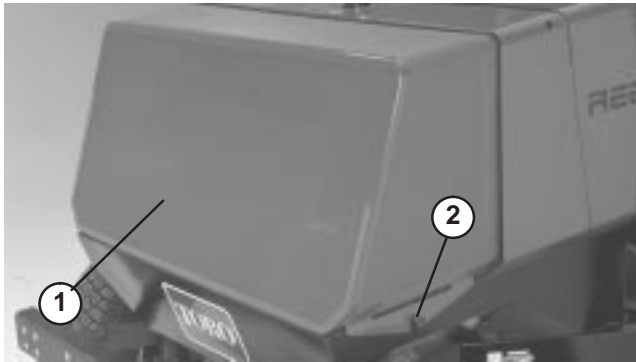

Figure 36

1. Rear screen 2. Knob

3. Lift up on oil cooler handles and pivot rearward in mounting slot. Clean both sides of oil cooler, radiator and rear engine area thoroughly with compressed air.
4. Pivot oil cooler back into position and install rear screen.
5. Lower engine cover and secure latches.

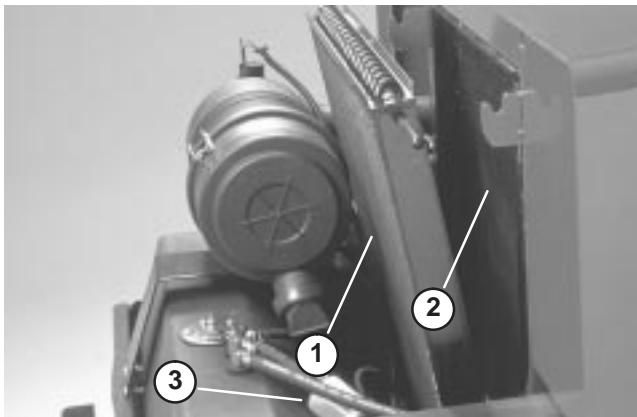

Figure 37

1. Oil cooler 3. Inline fuel filter
2. Radiator

Maintaining Cooling System

Capacity of the system is 3.7 gal. (14 L). Always protect cooling system with a 50/50 solution of water and ethylene glycol anti-freeze. **DO NOT USE WATER ONLY IN COOLING SYSTEM.**

- After every 100 operating hours, tighten hose connections. Replace any deteriorated hoses.

- After every 800 operating hours, drain and flush the cooling system. Add anti-freeze (refer to Check Cooling System).

Alternator Belt

Condition and Tension

Check condition and tension of belt (Fig. 38) after every 100 operating hours.

- Proper tension will allow 3/8 in. (10 mm) deflection when a force of 10 lbs. is applied on the belt midway between the pulleys.
- If deflection is not 3/8 in. (10 mm), loosen alternator mounting bolts. Increase or decrease alternator belt tension and tighten bolts. Check deflection of belt again to assure tension is correct.

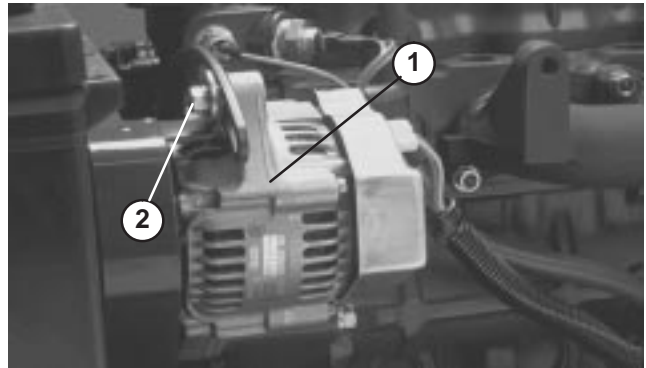

Figure 38

1. Alternator 2. Mounting bolt

Adjusting Hand Brake & Traction Switches

In time, the hand brake cable may stretch, causing the engine not to start. If this happens, adjust the cable (Fig. 39).

1. Pull brake lever to 3rd click.
2. Pull brake lever up one additional click.
3. Adjust four U-bracket nuts equally so spring has tension. Adjustment affects operation of traction switches.

- Adjust four U-bracket nuts so engine will start and run when hand brake is at fourth click, but will not start or run when hand brake is at second click.

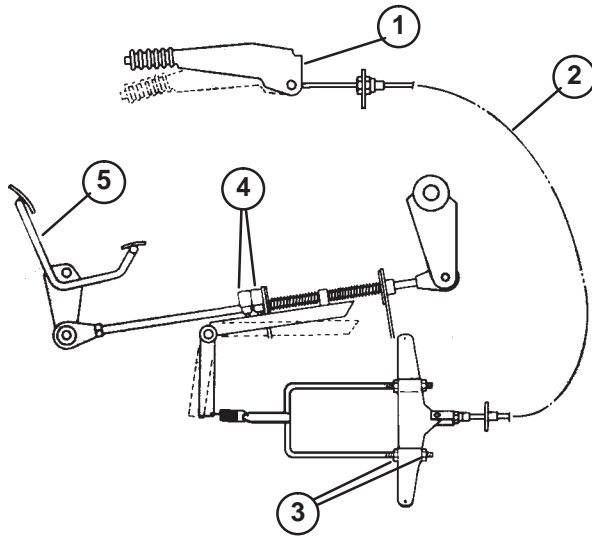

Figure 39

- | | |
|-------------------|----------------------|
| 1. Parking brake | 4. Traction switches |
| 2. Brake cable | 5. Traction pedal |
| 3. U-bracket nuts | |

Adding Hydraulic Oil

Capacity of the hydraulic reservoir is approximately 9.3 gal. (35.2 L).

With machine on a level surface, hydraulic oil level should be 1/4 to 1/2 inch below arrows on sight glass, when oil is cold. Warm oil should be even with arrows on sight glass (Fig. 40). If level is low, add hydraulic oil.



Figure 40

- Sight glass arrows

- Remove seat lock pin, raise seat and hold open with support rod.
- Clean around reservoir cover (Fig. 41). Remove cover and add hydraulic oil until it is even with arrows on sight glass (Fig. 40). Refer to Checking the Hydraulic Oil.

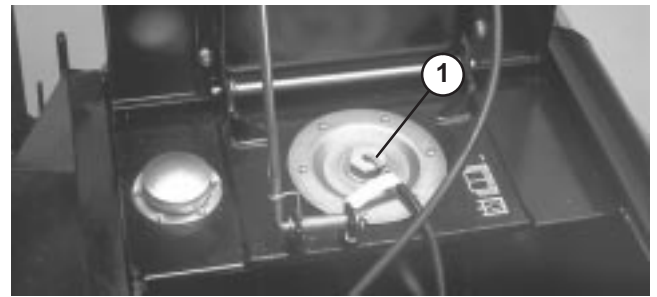

Figure 41

- Reservoir cover

Important To prevent contamination, clean top of hydraulic oil containers before opening. Assure pour spout and funnel are clean.

- Install reservoir cover, lower seat and secure with lock pin.

Draining Water From Hydraulic Reservoir

After every 100 operating hours, drain water from hydraulic reservoir. Before draining, allow machine to set about 8 hours to allow water to settle to bottom of reservoir.

- Open drain plug (Fig. 42) one-half turn and allow fluid to flow into drain pan until water is not noticed in hydraulic oil.

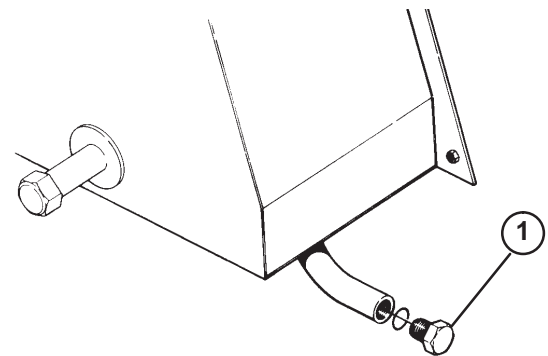

Figure 42

- Drain plug
- Tighten drain plug and add hydraulic oil, Refer to Adding Hydraulic Oil.

Changing Hydraulic Oil

Normally, change hydraulic oil after every 2 years or 1500 operating hours. If oil becomes contaminated, contact your local TORO distributor because the system must be flushed. Contaminated oil looks milky or black when compared to clean oil.

1. Remove drain plug (Fig. 42) from reservoir and let hydraulic oil flow into drain pan. Tighten plug when hydraulic oil stops draining.
2. Fill reservoir with approximately 9.3 gallons of hydraulic oil. Refer to Checking the Hydraulic Oil.

Important Use only hydraulic oils specified. Other fluids could cause system damage.

3. Install reservoir cover, lower seat and secure with lock pin. Start engine, run slowly and use all hydraulic controls to distribute hydraulic oil throughout the system. Also check for leaks. Then stop the engine.
4. With cutting units up and oil warm, look into sight glass (Fig. 40). If hydraulic oil is not even with arrows, add enough to raise to proper level. Do not fill full if oil is cold.

Replacing Hydraulic Filter

Initially, change filter after the first 50 operating hours, thereafter, every 800 operating hours, annually, or on indication.

Use Toro replacement filter (Part No. 86-6110).

Important Use of any other filter may void the warranty on some components.

1. Remove seat lock pin, raise seat and hold open with support rod. Also remove panel (secured with magnets) ahead of the seat.
2. Clean area around filter mounting area (Fig. 43). Place drain pan under filter and remove filter.
3. Lubricate new filter gasket and fill the filter with hydraulic oil.
4. Assure filter mounting area is clean. Screw filter on until gasket contacts mounting plate. Then tighten filter one-half turn.
5. Start engine and let it run slowly for about two minutes to purge air from the system. Stop the engine and check for leaks.

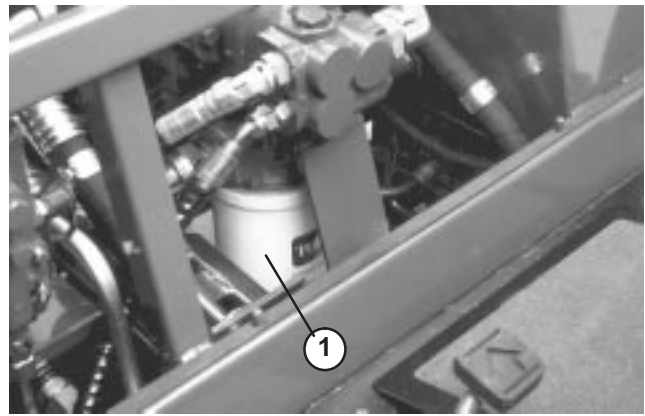

Figure 43

1. Hydraulic Filter

6. Look into sight glass (Fig. 40). Hydraulic oil level should be even with arrows when oil is warm. If level is low, add hydraulic oil to the reservoir.

Note: Under certain conditions, a bypass valve in the filter mounting plate allows oil to bypass the filter. Before the filter starts to bypass a warning light on the steering console will illuminate. The warning light may come on momentarily when the oil is cold. If the light does not go out after the oil is warm, the filter is clogged or an electrical problem exists. Correct problem before commencing operation.

Replacing Hydraulic System Breather

Change hydraulic system breather after every 800 operating hours, or annually, whichever comes first. More often in extremely dusty or dirty conditions.

1. Release latches and open engine cover.
2. Clean around the breather and unscrew it with a wrench (Fig. 44). Install new breather.



Figure 44

1. Breather

3. Close engine cover and latch securely.

Checking Hydraulic Lines And Hoses

Check hydraulic lines and hoses daily for leaks, kinked lines, loose mounting supports, wear, loose fittings, weather deterioration and chemical deterioration. Make all necessary repairs before operating.

Hydraulic System Test Ports

The test ports (Fig. 45 & 46) are used to test the hydraulic circuits. Check all pressures when engine is at full speed and hydraulic oil is at normal operating temperature. Contact your local Toro distributor for assistance.

1. Traction Forward and Reverse (Fig. 45) (behind wheel motors) has a normal relief setting of approximately 5300 psi and 50 – 150 psi charge pressure. Use a gauge with 7500 – 10,000 psi full scale rating.

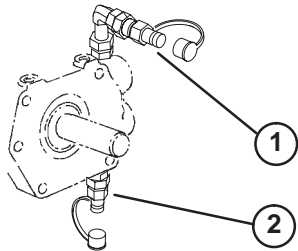

Figure 45

1. Traction forward
2. Traction reverse

2. Cutting unit Counterbalance has adjustable pressure.

- Normal Setting
Hot Oil: 500–550 psi
Cold Oil: 600–650 psi
- Maximum Hill Climbing Setting
Hot Oil: 550+ psi
Cold Oil: 650+ psi
- Maximum Quality of Cut Setting
Hot Oil: 500 psi
Cold Oil: 600 psi
- Lift circuit relief pressure is approximately 2650 psi when counterbalance setting is 550 psi.

Note: Changes in counterbalance setting will effect the lift circuit relief pressure.

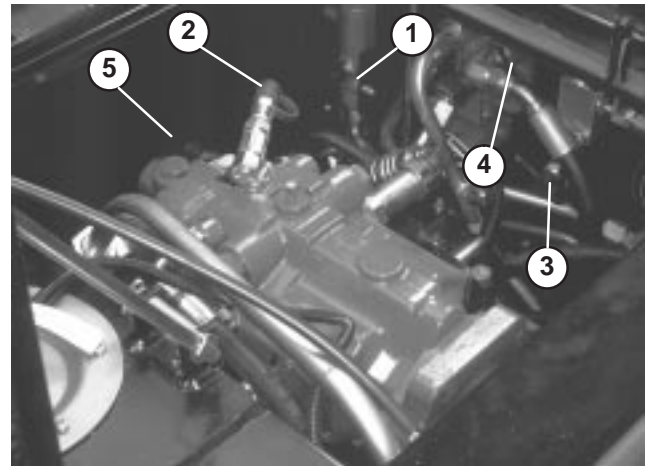

Figure 46

1. Lift relief circuit
2. Charge pressure circuit
3. Cutting unit counterbalance
4. Cutting unit circuit
5. Steering circuit

3. Cutting Unit Circuit has a normal relief setting of approximately 2700–3000 psi.
4. Steering Circuit has a normal relief setting of approximately 1500 psi.
5. Lift/relief Circuit has a normal relief setting of approximately 2650–2750 psi.
6. Charge Pressure Circuit has a normal relief setting of approximately 100–150 psi.

Rear Wheel Toe-in

After every 800 operating hours or annually, check rear wheel toe-in.

1. Measure center-to-center distance (at axle height) at front and rear of steering tires (Fig. 47). Front measurement must be 1/8 in. less than rear measurement.



Figure 47

2. Loosen clamps at both ends of tie rods (Fig. 48).
3. Rotate tie rod to move front of tire inward or outward.
4. Tighten tie rod clamps when adjustment is correct.

Note: Make sure tie rod clamps are positioned so they do not interfere with steering linkage.

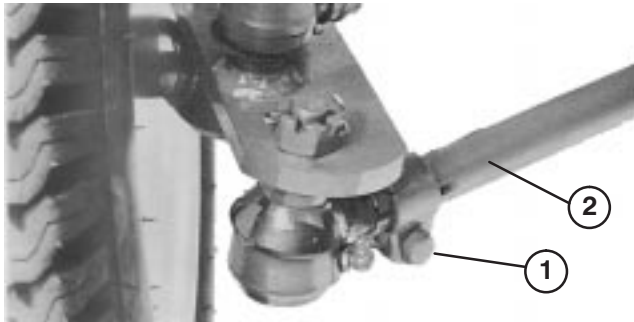

Figure 48

1. Clamp 2. Tie Rod

Checking Planetary Gear Drive

Initially, check oil level after 50 operating hours and check every 800 hours thereafter. Oil capacity is approximately 30 oz. (885 ml) high quality SAE 80-90 wt. Gear Lube (ISO 150/220).

1. To check the oil level, the oil should be at the bottom of the check/drain plug hole (Fig. 49) when the hole is placed in the 3 o'clock or 9 o'clock position. The traction unit must be on level ground when making this check.

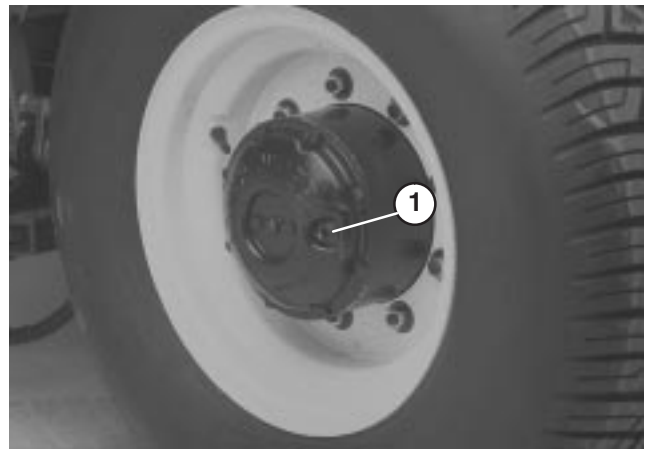

Figure 49

1. Check/drain plug

Engine Valve Clearance

Adjust every 800 operating hours.

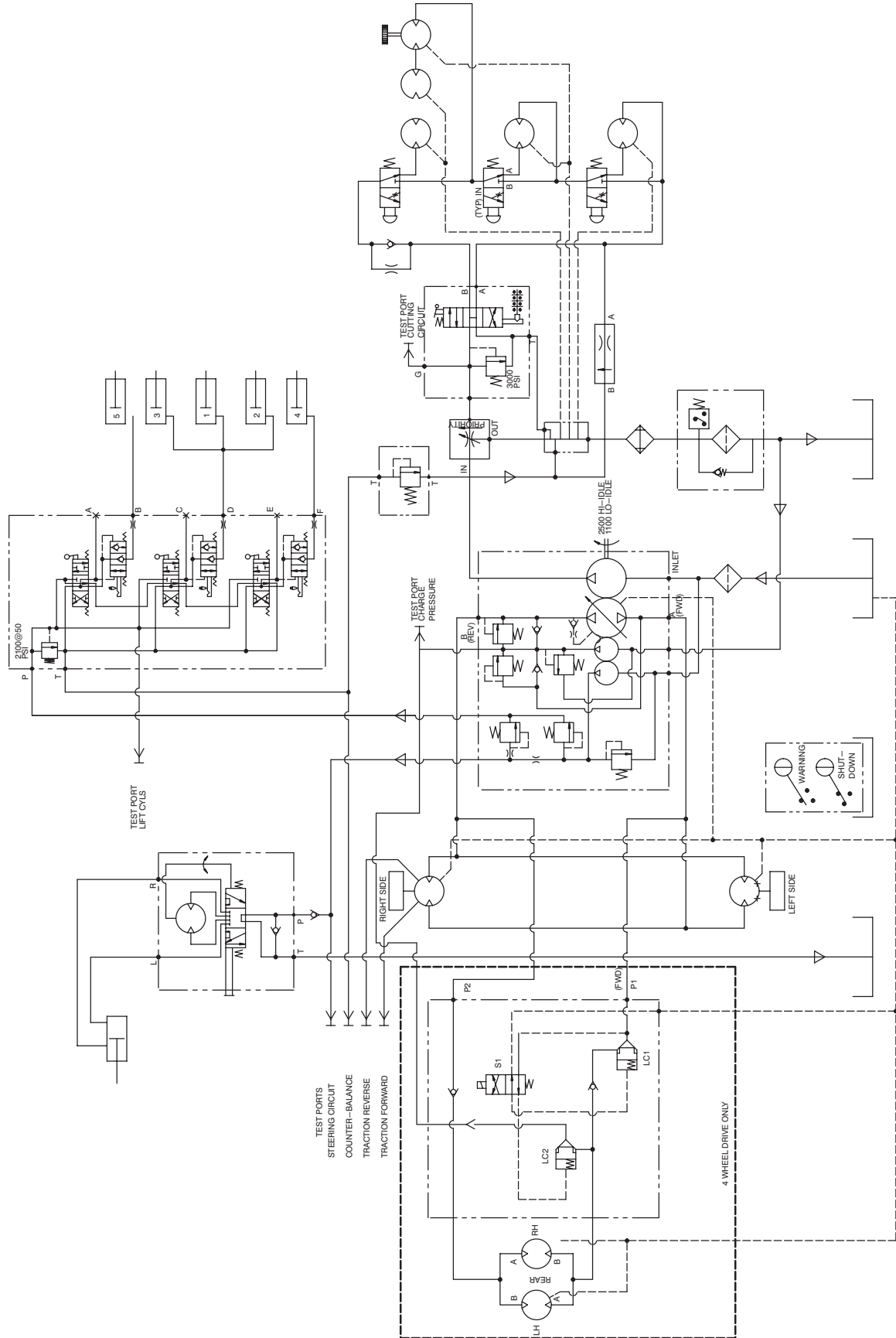

Hydraulic Schematic

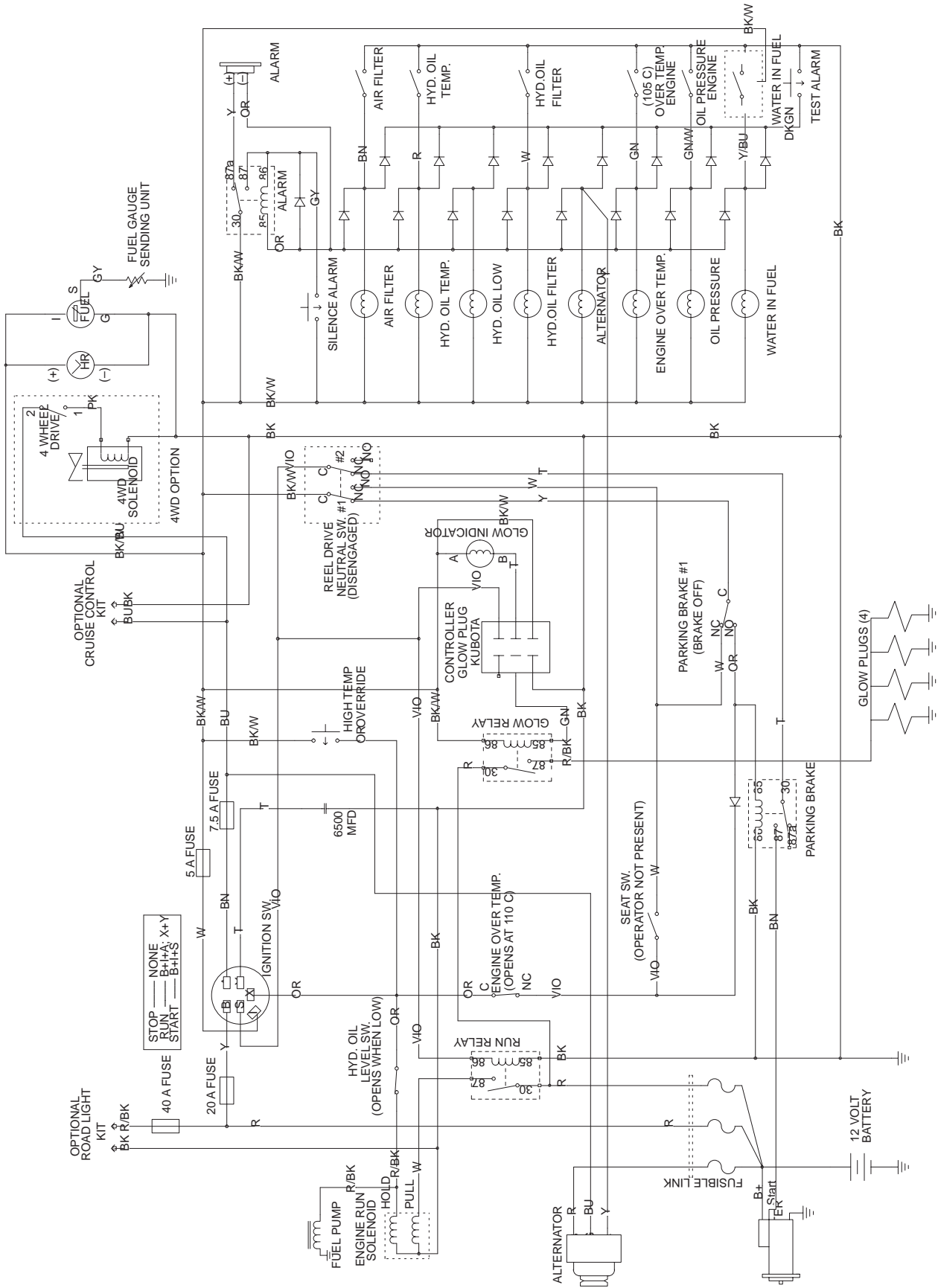

Electrical Schematic





Battery Care

 **Warning** 

CALIFORNIA
Proposition 65 Warning



Battery posts, terminals, and related accessories contain lead and lead compounds, chemicals known to the State of California to cause cancer and reproductive harm. *Wash hands after handling.*

Important Before welding on a machine, disconnect both cables from the battery, disconnect both wire harness plugs from the electronic control unit and the terminal connector from the alternator to prevent damage to the electrical system.

 **Warning** 

Battery terminals or metal tools could short against metal tractor components causing sparks. Sparks can cause the battery gasses to explode, resulting in personal injury.



- **When removing or installing the battery, do not allow the battery terminals to touch any metal parts of the machine.**
- **Do not allow metal tools to short between the battery terminals and metal parts of the machine.**

 **Warning** 

Incorrect battery cable routing could damage the tractor and cables causing sparks. Sparks can cause the battery gasses to explode, resulting in personal injury.

- **Always *disconnect* the negative (black) battery cable before disconnecting the positive (red) cable.**
- **Always *connect* the positive (red) battery cable before connecting the negative (black) cable.**

Note: Check battery condition weekly or after every 50 hours of operation. Keep terminals and entire battery case clean because a dirty battery will discharge slowly. To clean the battery, wash the entire case with solution of baking soda and water. Rinse with clear water. Coat the battery posts and cable connectors with Grafo 112X (skin-over) grease (Toro Part No. 505-47) or petroleum jelly to prevent corrosion.

 **Danger** 

Battery electrolyte contains sulfuric acid which is a deadly poison and causes severe burns.

- **Do not drink electrolyte and avoid contact with skin, eyes or clothing. Wear safety glasses to shield your eyes and rubber gloves to protect your hands.**
- **Fill the battery where clean water is always available for flushing the skin.**



The Toro General Commercial Products Warranty

A Two-Year Limited Warranty

Conditions and Products Covered

The Toro Company and its affiliate, Toro Warranty Company, pursuant to an agreement between them, jointly warrant your 1996 or newer Toro Commercial Product ("Product") purchased after January 1, 1997, to be free from defects in materials or workmanship for two years or 1500 operational hours*, whichever occurs first. Where a warrantable condition exists, we will repair the Product at no cost to you including diagnosis, labor, parts, and transportation. This warranty begins on the date the Product is delivered to the original retail purchaser.

* Product equipped with hour meter

Instructions for Obtaining Warranty Service

You are responsible for notifying the Commercial Products Distributor or Authorized Commercial Products Dealer from whom you purchased the Product as soon as you believe a warrantable condition exists.

If you need help locating a Commercial Products Distributor or Authorized Dealer, or if you have questions regarding your warranty rights or responsibilities, you may contact us at:

Toro Commercial Products Service Department
Toro Warranty Company
8111 Lyndale Avenue South
Bloomington, MN 55420-1196
952-888-8801 or 800-982-2740
E-mail: commercial.service@toro.com

Owner Responsibilities

As the Product owner, you are responsible for required maintenance and adjustments stated in your operator's manual. Failure to perform required maintenance and adjustments can be grounds for disallowing a warranty claim.

Items and Conditions Not Covered

Not all product failures or malfunctions that occur during the warranty period are defects in materials or workmanship. This express warranty does not cover the following:

- Product failures which result from the use of non-Toro replacement parts, or from installation and use of add-on, modified, or unapproved accessories
- Product failures which result from failure to perform required maintenance and/or adjustments
- Product failures which result from operating the Product in an abusive, negligent or reckless manner
- Parts subject to consumption through use unless found to be defective. Examples of parts which are consumed, or used up, during normal Product operation include, but are not limited to, blades, reels, bedknives, tines, spark plugs, castor wheels, tires, filters, belts, etc.

Countries Other than the United States or Canada

Customers who have purchased Toro products exported from the United States or Canada should contact their Toro Distributor (Dealer) to obtain guarantee policies for your country, province, or state. If for any reason you are dissatisfied with your Distributor's service or have difficulty obtaining guarantee information, contact the Toro importer. If all other remedies fail, you may contact us at Toro Warranty Company.

- Failures caused by outside influence. Items considered to be outside influence include, but are not limited to, weather, storage practices, contamination, use of unapproved coolants, lubricants, additives, or chemicals, etc.
- Normal "wear and tear" items. Normal "wear and tear" includes, but is not limited to, damage to seats due to wear or abrasion, worn painted surfaces, scratched decals or windows, etc.

Parts

Parts scheduled for replacement as required maintenance are warranted for the period of time up to the scheduled replacement time for that part.

Parts replaced under this warranty become the property of Toro. Toro will make the final decision whether to repair any existing part or assembly or replace it. Toro may use factory remanufactured parts rather than new parts for some warranty repairs.

General Conditions

Repair by an Authorized Toro Distributor or Dealer is your sole remedy under this warranty.

Neither The Toro Company nor Toro Warranty Company is liable for indirect, incidental or consequential damages in connection with the use of the Toro Products covered by this warranty, including any cost or expense of providing substitute equipment or service during reasonable periods of malfunction or non-use pending completion of repairs under this warranty. Except for the Emissions warranty referenced below, if applicable, there is no other express warranty. All implied warranties of merchantability and fitness for use are limited to the duration of this express warranty.

Some states do not allow exclusions of incidental or consequential damages, or limitations on how long an implied warranty lasts, so the above exclusions and limitations may not apply to you.

This warranty gives you specific legal rights, and you may also have other rights which vary from state to state.

Note regarding engine warranty: The Emissions Control System on your Product may be covered by a separate warranty meeting requirements established by the U.S. Environmental Protection Agency (EPA) and/or the California Air Resources Board (CARB). The hour limitations set forth above do not apply to the Emissions Control System Warranty. Refer to the Engine Emission Control Warranty Statement printed in your operator's manual or contained in the engine manufacturer's documentation for details.