



Count on it.

Parts Catalog

Groundsmaster® 4010

Rotary Mower

Model No. 30635—Serial No. 405226001 and Up



Ordering Replacement Parts

To order replacement parts, please supply the part number, the quantity, and the description of each part desired.

Understanding Reference Numbers

Each identified part in an illustration has a reference number. The reference number for a part also appears in the parts list, along with other information about the part.

This catalog uses two special reference number formats, one to indicate parts in a service assembly and another to indicate the quantity of a given part in an illustration.

Service Assembly Reference Numbers

Parts in service assemblies have reference numbers in the form a:b. The a represents the reference number of the entire service assembly and the b represents a sequential number unique to each part within the service assembly.

For example, a wheel assembly might be identified by reference number 6, the tire by 6:1, the valve by 6:2, and the wheel by 6:3. When you order the assembly identified by reference number 6, you receive all parts identified by reference numbers 6:1, 6:2, and 6:3. However, you may also order any part individually. Reference numbers of this type appear in illustration and in parts lists.

Reference Numbers Indicating Quantity

In an illustration, if a reference number indicates more than one part, the reference number has the form nX y. The n represents the quantity of the part, the X is the multiplication symbol, and the y represents the reference number.

For example, in an illustration, the reference number 2X 37 means that two of the parts identified by reference number 37 are indicated.

Contents

Front Frame and Steering Assembly	6
Planetary Assembly No. 136-2913	7
LH Brake Assembly No. 100-3070-03	8
RH Brake Assembly No. 100-3069-03	9
Battery, Shield and Rear Cover Assembly	10
Wing Lift Arm Assembly	11
Hydraulic Cylinder Assembly No. 139-0956	13
Impact Arm Assembly	14
Frame, Bumper and Proximity Sensor Assembly	16
Cab Step Assembly	17
Flywheel and Motor Mount Assembly	18
Radiator Assembly	19
Fan Mounting and Hardline Assembly	21
Hydraulic Motor Assembly No. 137-5571	22
Engine, Intake and Exhaust Assembly	23
Air Conditioner Compressor Assembly	24
Washer Fluid Bottle Assembly	25
Rear Axle and Steering Cylinder Assembly	26
Bevel Pinion Shaft Assembly Rear Axle Assembly No. 110-4750	28
Differential Assembly Rear Axle Assembly No. 110-4750	29
Axle Support Assembly Rear Axle Assembly No. 110-4750	30
Bevel Gear Case Assembly Rear Axle Assembly No. 110-4750	31
Bevel Gear Shaft Assembly Rear Axle Assembly No. 110-4750	32
Axle Case Assembly Rear Axle Assembly No. 110-4750	33
Axle Assembly Rear Axle Assembly No. 110-4750	34
Hydraulic Motor Assembly No. 120-8814	35
Steering Cylinder Assembly No. 121-1534	36
Hydraulic Fitting Assembly	37
Hose and Tube Routing Assembly	38
Fuel Tank and Air Cleaner Assembly	39
Air Cleaner Assembly No. 99-5410	40
Hood Assembly	41
Fuel/Water Separator Assembly	42
Front Deck Installation Assembly	43
Hydraulic Motor Assembly No. 127-3694	45
Lift Cylinder Assembly No. 120-8802	46
Front Deck Hydraulic Fitting Assembly	47
Front Deck Hose Routing Assembly	48
Front Deck Idler and Skid Assembly	49
Double Driven Spindle Assembly No. 119-4548	51
High Driven Spindle Assembly No. 119-4549	52
Front Deck Caster Arm and Wheel Assembly	54
Driving Spindle Assembly	56
Driven Spindle Assembly No. 119-4547	58
Cutting Chamber, Cover and Roller Assembly	60
Right Deck Mount Assembly	62
Right Deck Hydraulic Fitting Assembly	63
Right Deck Hose Assembly	64
Right Deck, Idler and Skid Assembly	66
Low Driven Spindle Assembly No. 119-4776	68
Right Hand and Left Hand Castor Arm and Wheel Assembly	70
LH and RH Deck Driving Spindle Assembly	72
Right Deck Discharge Chamber and Cover Assembly	74
Left Deck Mount Assembly	76

Contents (continued)

Left Deck Hydraulic Fitting Assembly	77
Left Deck Hose Assembly	78
Left Deck, Idler and Skid Assembly	80
Left Deck Discharge Chamber and Cover Assembly	82
Traction Pedal and Platform Assembly	84
Brake Pedal Assembly	86
Seat Base and Seat Assembly	87
Cloth Premium Seat Assembly No. 117-9429	89
Seat Suspension Assembly No. 130-2702	90
Steering and Controller Assembly	92
Steering Column Assembly No. 132-6230	94
RH Fender Assembly	95
Fender Assembly	96
Acoustic Foam, Panel and Cover Assembly	97
Platform Wire Harness and Fuse Assembly	98
Rear Wire Harness Assembly	99
Battery Cable and Ground Assembly	100
Engine Harness Assembly	101
Piston Pump and Gear Pump Assembly	102
4-Section Gear Pump Assembly No. 120-8904	104
Hydraulic Pump Assembly No. 132-6100	106
Combination Manifold Assembly	108
Combination Manifold Assembly No. 137-5582	109
Manifold Block Assembly	111
Left PTO Manifold Assembly No. 131-1249	113
Rear Traction Manifold Assembly No. 121-1530	114
Center and Right PTO Manifold Assembly No. 131-1248	115
Flow Divider Manifold Assembly No. 121-1550	116
Drive Motor, Steer Valve and Filter Head Assembly	117
Hydraulic Motor Assembly No. 120-8812	118
Steering Valve Assembly No. 132-6256	120
Hydraulic Reservoir Assembly	122
Lift, Steer and Fan Hydraulic Assembly	124
Oil Cooler Hydraulic Assembly	126
Traction Hydraulic Assembly	127
Armrest Control Panel Assembly	128
Cab, Tool Box and Flooring Assembly	130
Frame, Mount and Seal Assembly	132
Cab Headliner Assembly	134
Air Conditioning Duct Assembly No. 132-3468	136
Fan Panel Assembly No. 132-3488	138
Window, Door and Striker Assembly	140
RH Door Assembly	142
LH Door Assembly	143
Engine Hose Routing Assembly	144
Pre-Filter Screen Assembly	146
Interior Foam Assembly	148
Roof and Headliner Assembly	150
Headliner Wire Harness and Control Assembly	152
Mixing Box Mounting Bracket and Water Tray Assembly	154
Blower Fan and Evaporator Core Assembly	156
Heat/Air Conditioner Housing Assembly	158
Air Diverter and Expansion Valve Assembly	160
Air Diverter Assembly No. 121-8369	162

Contents (continued)

Cylinder Block Assembly	164
Gear Housing Assembly	165
Cylinder Head and Bonnet Assembly	166
Fuel Injection Pump Assembly	168
Flywheel Housing and Oil Sump Assembly	170
Suction Manifold Assembly	171
Exhaust Manifold and Silencer Assembly	172
Camshaft and Driving Gear Assembly	173
Turbine Assembly	174
Crankshaft and Piston Assembly	175
Lubrication and Oil System Assembly	176
Lubrication Oil Line Assembly	177
Cooling Water System Assembly	178
Governor Assembly	179
Fuel Injection Valve Assembly	180
Starting Motor Assembly	181
Generator Assembly	182
Electronic Control Unit Assembly	183
Gasket Set	184
Attachments and Accessories	185

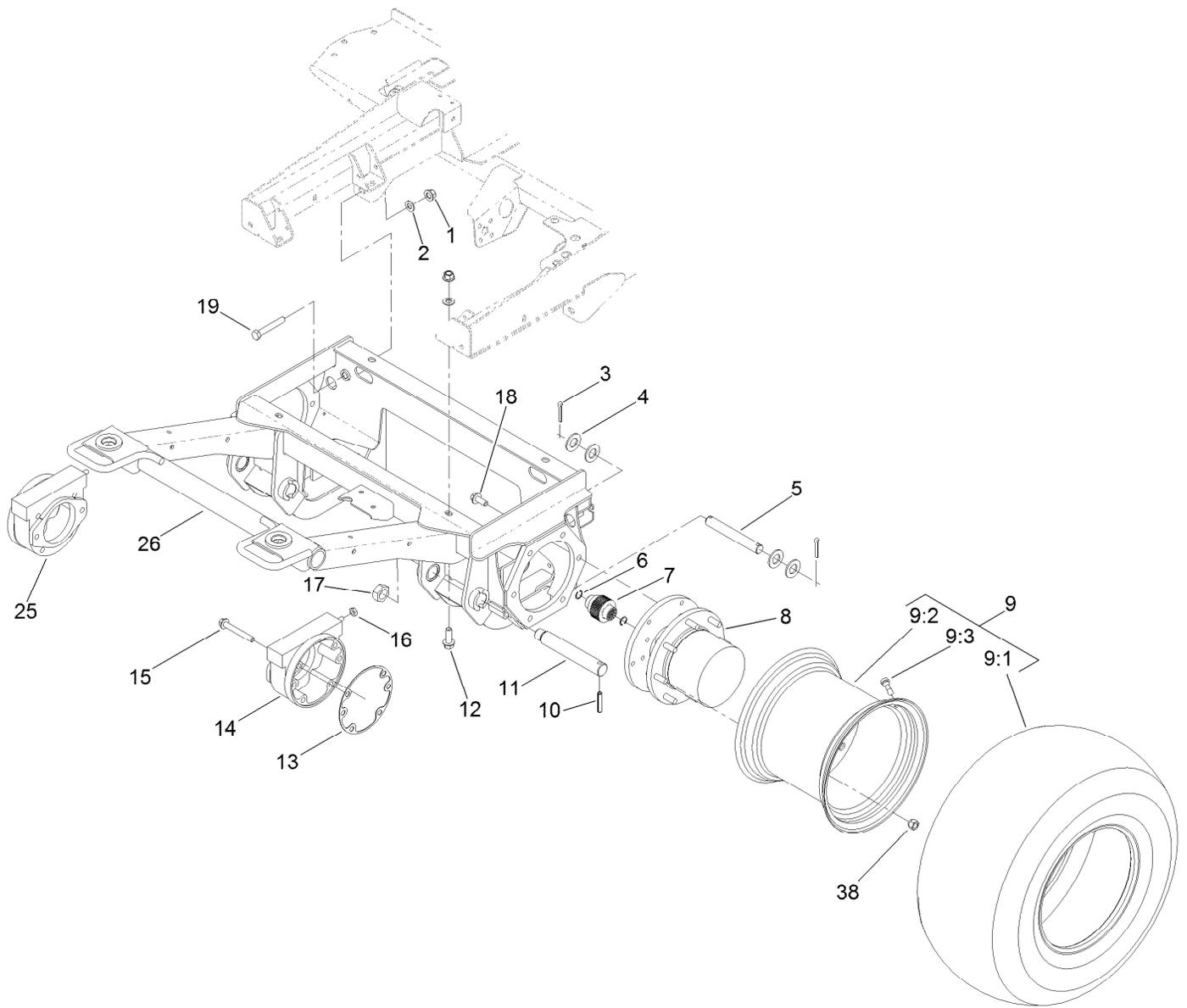

Front Frame and Steering Assembly

Ref.	Part Number	Qty.	Description	Ref.	Part Number	Qty.	Description
1	99-5107	6	Nut-Lock	11	100-3017	2	*obs Pin-Lift Arm
2	3256-26	6	Washer-Flat	12	100-6116	4	Screw-HHF
3	3272-30	4	Pin-Cotter	13	93-7984	2	Gasket
4	3256-29	8	Washer-Flat	14	100-3070-03	1	Brake ASM
5	110-6006	2	Pin-Clevis	15	33106-080	8	Screw-HHF
6	93-7972	4	Ring-Retaining, Internal	16	3218-4	2	Nut-Jam
7	100-3046	2	Shaft-Brake, Splined	17	3296-49	2	Nut-Lock, NI
8	136-2913	2	Planetary ASM	18	33106-030	12	Screw-HHF
9		2	Wheel And Tire ASM ●	19	325-13	2	Screw-HH
9:1	119-8313	1	Tire	25	100-3069-03	1	Brake ASM
9:2	136-4391	1	Rim	26	132-6250-03	1	Frame-Front
9:3	232-27	1	Stem-Valve	38	242-50	16	Nut-Lug
10	32121-110	2	Pin-Roll, Slotted				

● Not serviced separately

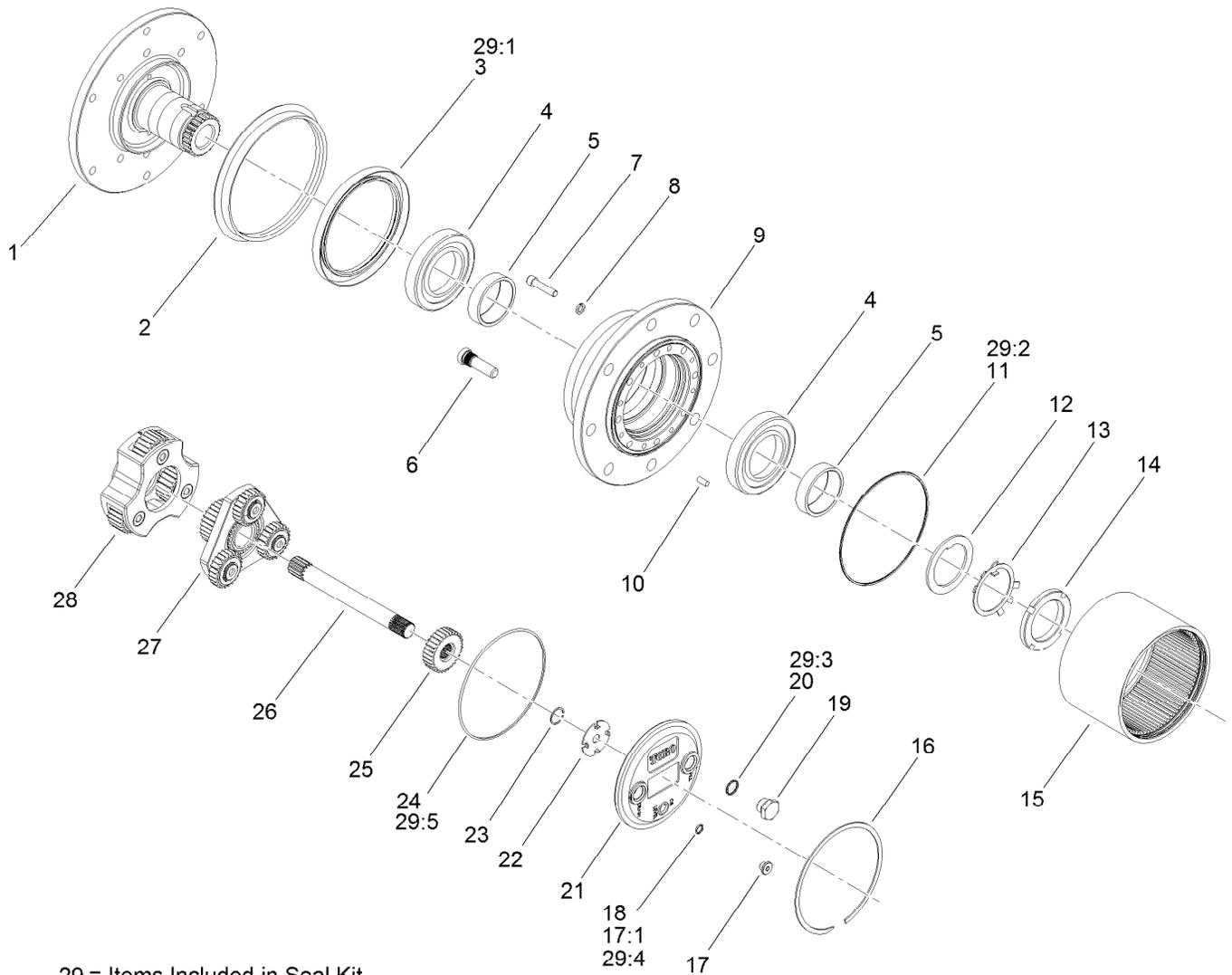

29 = Items Included in Seal Kit

Planetary Assembly No. 136-2913

Ref.	Part Number	Qty.	Description	Ref.	Part Number	Qty.	Description
1		1	Spindle ●	18	237-78	1	O-Ring
2	138-1204	1	Seal-Boot	19	138-1211	2	Plug-Flange, Magnetic
3		1	Seal-Lip ●	20	138-1212	2	O-Ring
4	138-1205	2	Bearing-Cup	21	138-1213	1	Cap-End
5	138-1206	2	Bearing-Cone	22	138-1214	1	Washer-Thrust, Sun
6	105-8124	8	Stud-Wheel	23	105-8131	2	Ring-Retaining
7	138-1207	8	Screw-Socket Head	24		1	O-Ring ●
8	138-1208	8	Washer-Lock	25	138-1215	1	Gear-Primary, Sun
9		1	Housing ●	26	138-1216	1	Shaft-Drive
10	105-8121	4	Pin-Dowel	27	138-1217	1	Primary Carrier ASM
11		1	O-Ring ●	28	138-1218	1	Secondary Carrier ASM
12	138-6928	1	Spacer	29	138-1219	1	Seal Kit
13	138-6929	1	Washer	29:1		1	Seal-Lip ●
14	138-6930	1	Nut-Lock	29:2		1	O-Ring ●
15	138-1209	1	Gear-Ring	29:3		1	O-Ring ●
16	138-1210	1	Ring-Snap	29:4		1	O-Ring ●
17	353-990	1	Plug ASM	29:5		1	O-Ring ●
17:1	237-78	1	O-Ring				

● Not serviced separately

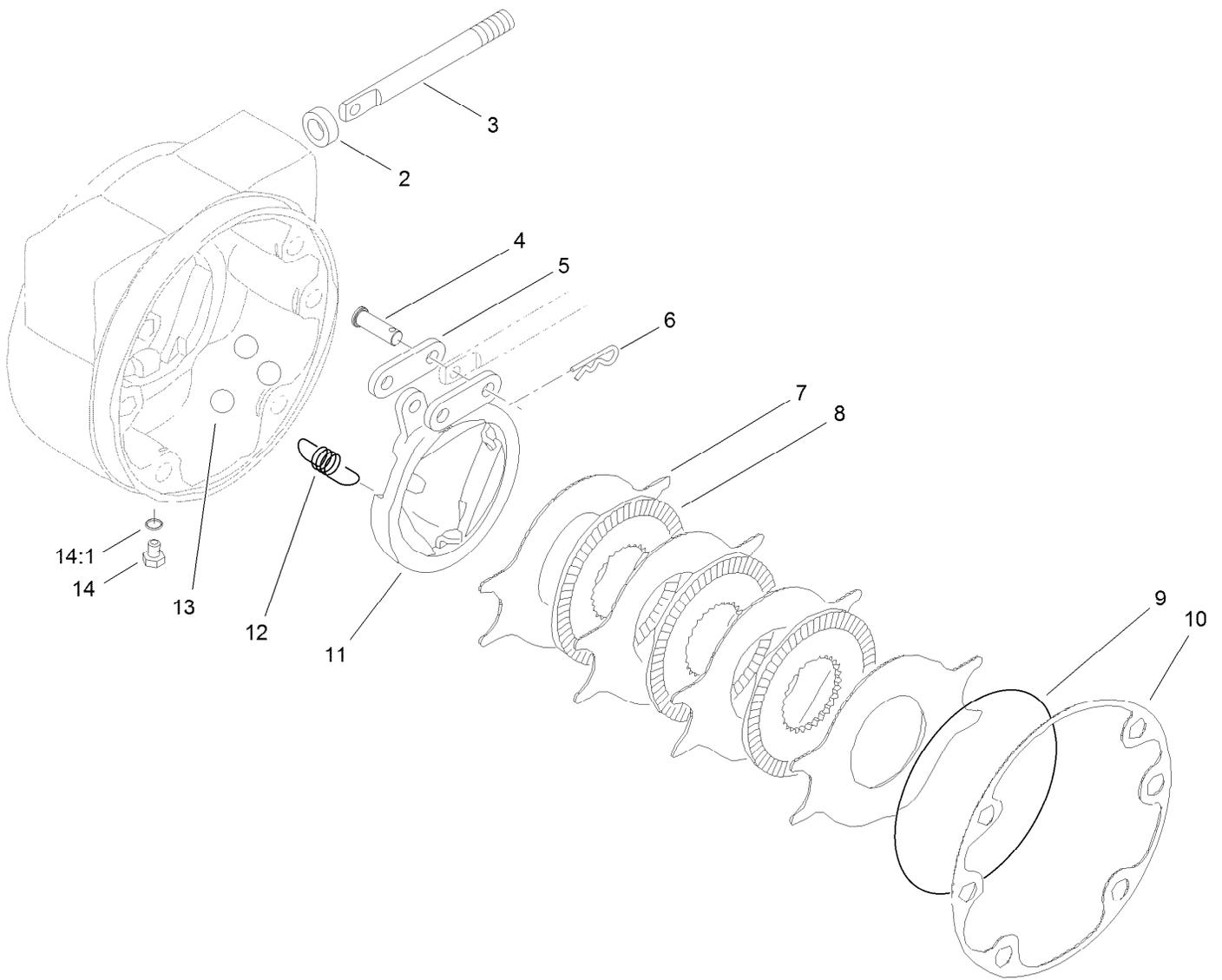

LH Brake Assembly No. 100-3070-03

<i>Ref.</i>	<i>Part Number</i>	<i>Qty.</i>	<i>Description</i>
2	93-7977	1	Seal
3	93-7978	1	Rod-Pull
4	93-7983	2	Pin-Clevis
5	93-7980	2	Link
6	93-7979	2	Pin-Hitch
7	93-7986	4	Disc-Stationary
8	104-4278	3	Disc-Rotating
9	93-7976	1	Ring-Retaining
10	93-7984	1	Gasket
11	104-4279	1	Actuator-Rotating
12	93-7987	3	Spring-Extension
13	93-7985	3	Ball
14	353-990	2	Plug ASM
14:1	237-78	1	O-Ring

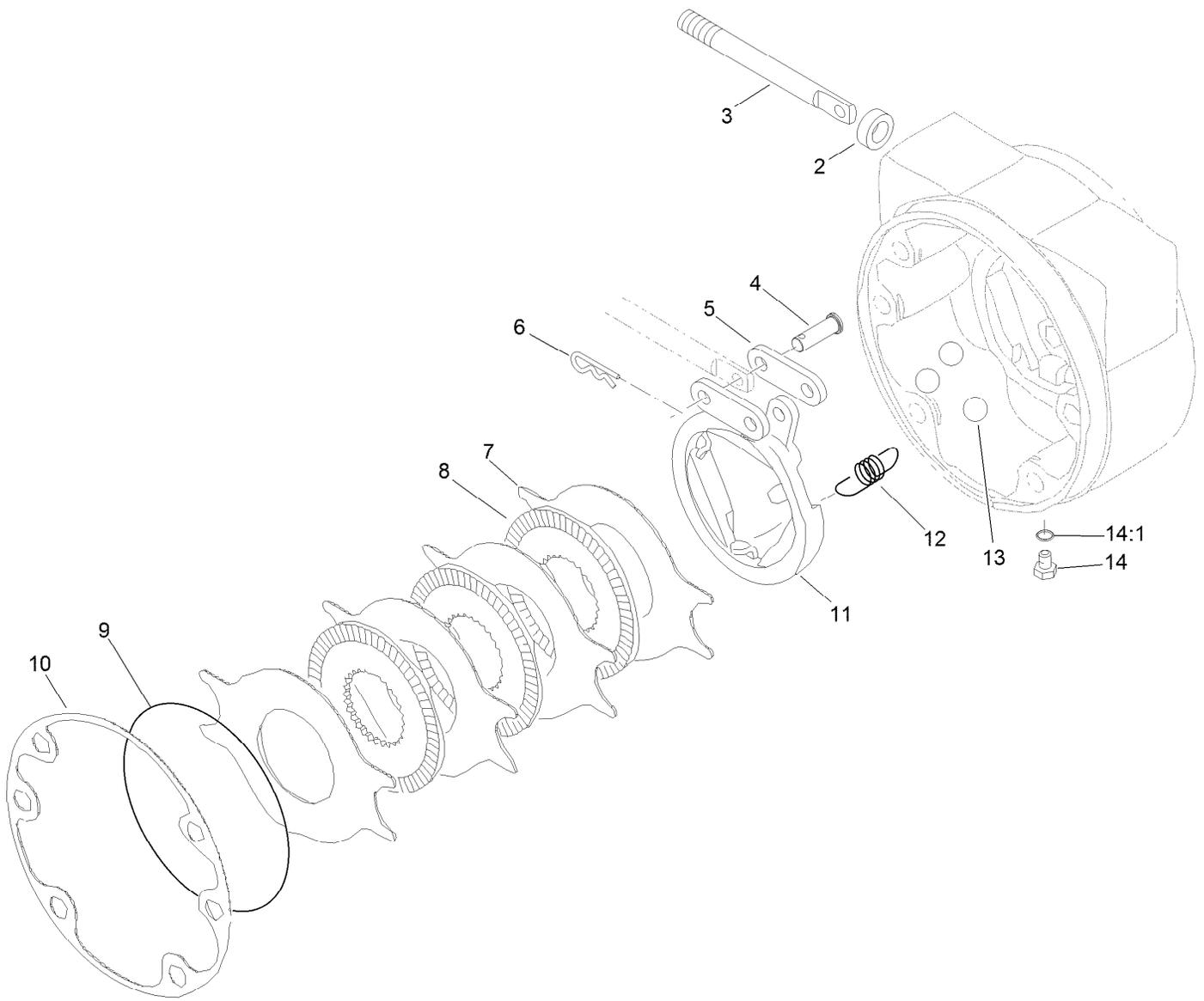

RH Brake Assembly No. 100-3069-03

<i>Ref.</i>	<i>Part Number</i>	<i>Qty.</i>	<i>Description</i>
2	93-7977	1	Seal
3	93-7978	1	Rod-Pull
4	93-7983	2	Pin-Clevis
5	93-7980	2	Link
6	93-7979	2	Pin-Hitch
7	93-7986	4	Disc-Stationary
8	104-4278	3	Disc-Rotating
9	93-7976	1	Ring-Retaining
10	93-7984	1	Gasket
11	104-4280	1	Actuator-Rotating
12	93-7987	3	Spring-Extension
13	93-7985	3	Ball
14	353-990	2	Plug ASM
14:1	237-78	1	O-Ring

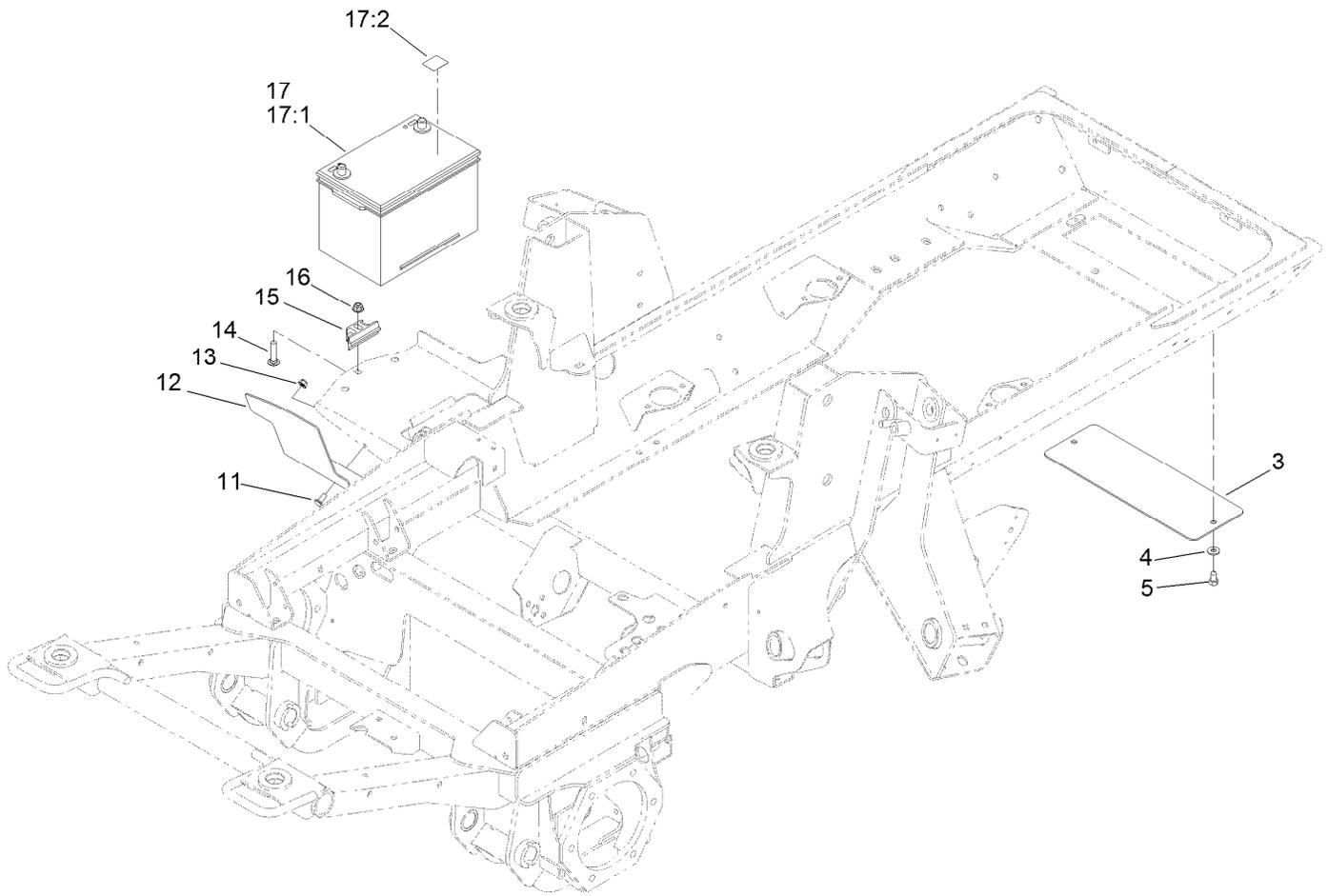

Battery, Shield and Rear Cover Assembly

Ref.	Part Number	Qty.	Description
3	131-1246-03	1	Plate-Cover
4	3256-3	2	Washer-Flat
5	32104-6	2	Screw-HH, TAP
11	3230-23	2	Bolt-CARR
12	121-1512-03	1	Shield-Battery
13	104-8300	2	Nut-HF, NI
14	3231-5	1	Screw-CARR
15	138-6335	1	Retainer-Battery
16	104-8301	1	Nut-HF, NI
17	139-1005	1	Battery Kit
17:1	127-7507	1	Battery
17:2	139-1006	1	Decal

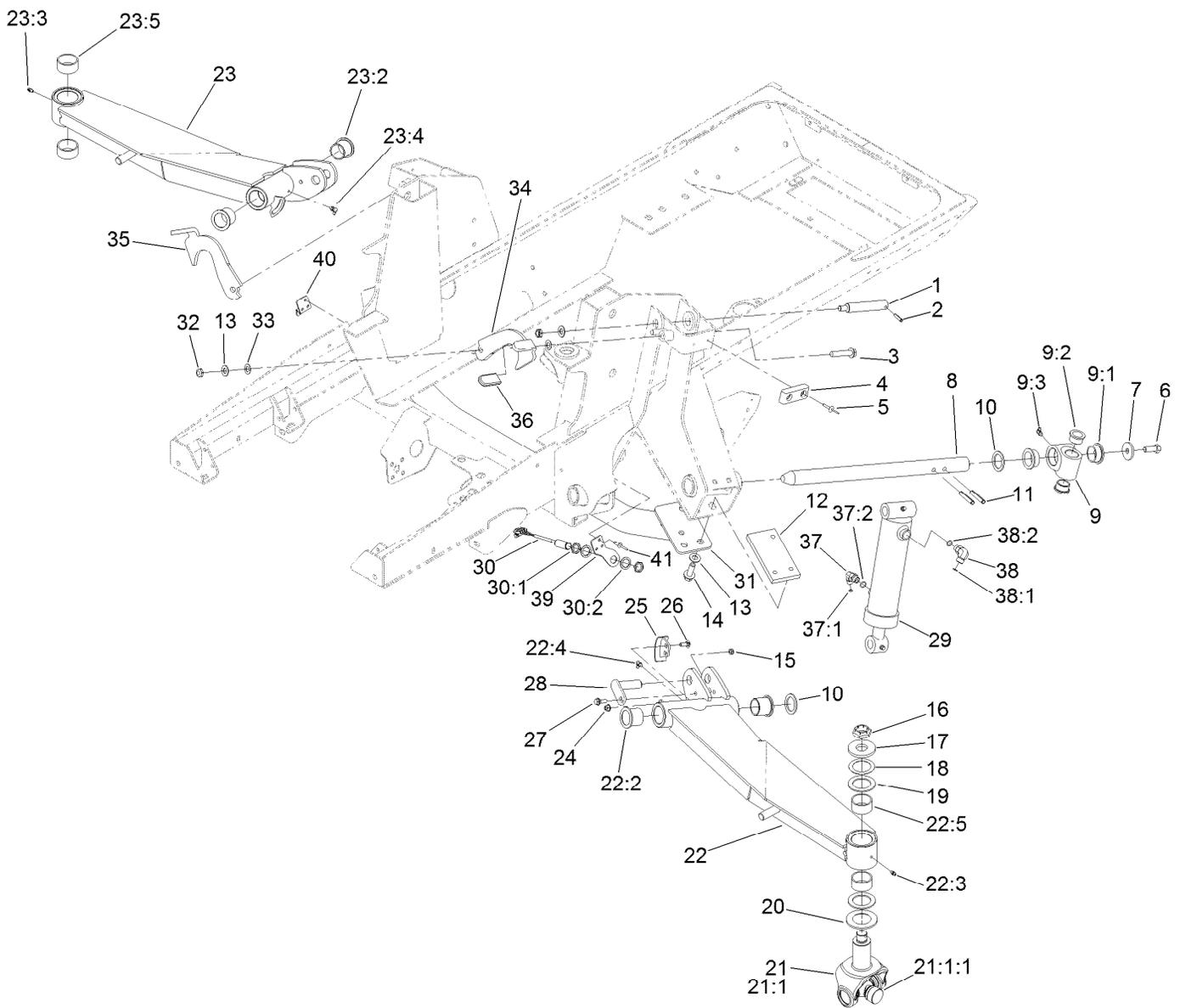

Wing Lift Arm Assembly

Ref.	Part Number	Qty.	Description	Ref.	Part Number	Qty.	Description
1	104-3537	2	Pin-Cylinder	16	116-1399	2	Locknut
2	32121-9	2	Pin-Roll, Slotted	17	104-0719	2	Washer-Hardened
3	3234-46	2	Screw-HHF	18	114-5641	2	Washer-Thrust
4	86-5350	2	Bumper-Rubber	19	104-0721	4	Washer-Thrust
5	3269-11	4	Rivet-Pop	20	104-0720	2	Spacer
6	325-5	2	Screw-HH	21	114-5640-03	2	Joint Yoke ASM
7	106-2008	2	Washer-Thrust	21:1		1	Yoke-Joint ●
8	121-3882	2	Shaft-Pivot, Lift Arm	21:1:1	104-4299	1	Cross And Bearing Kit
9	115-5468	2	Pivot Hub ASM	22	132-6210	1	LH Lift Arm ASM
9:1	115-5469	2	Bushing-Flange	22:2	69-6470	2	Bushing-Caster
9:2	114-5680	2	Bushing-Flange	22:3	302-5	1	Fitting-Grease
9:3	302-60	1	Fitting-Grease	22:4	302-60	1	Fitting-Grease
10	256-304	4	Washer-Thrust	22:5	114-5596	2	Bushing-Straight
11	117-5479	4	Pin-Spring	23	132-6217	1	RH Lift Arm ASM
12	120-8859-03	2	Block-Tapped	23:2	69-6470	2	Bushing-Caster
13	3256-26	10	Washer-Flat	23:3	302-5	1	Fitting-Grease
14	100-6116	6	Screw-HHF	23:4	302-60	1	Fitting-Grease
15	3296-47	2	Nut-Lock,NI	23:5	114-5596	2	Bushing-Straight

● Not serviced separately

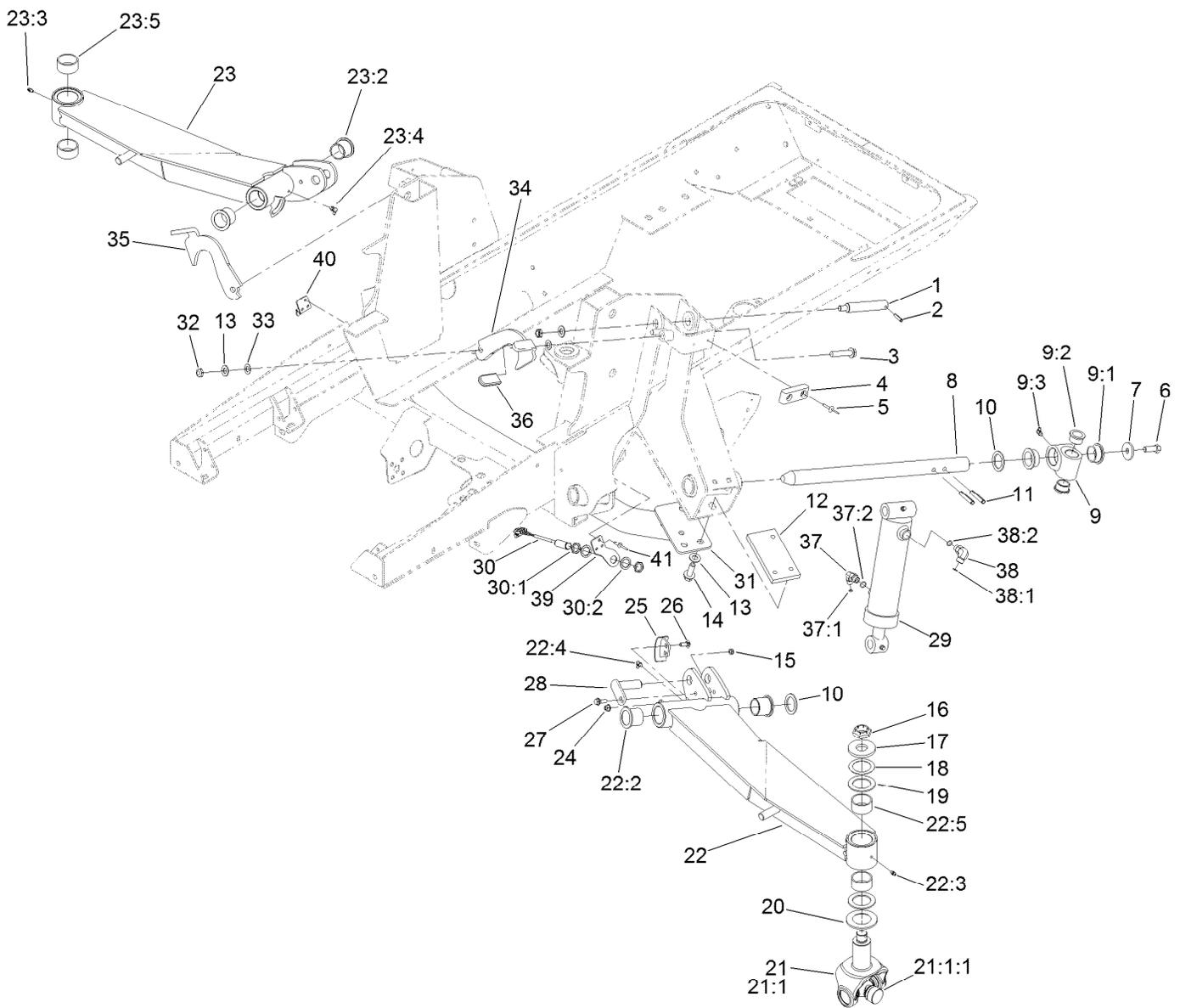

Wing Lift Arm Assembly (continued)

Ref.	Part Number	Qty.	Description	Ref.	Part Number	Qty.	Description
24	104-8300	4	Nut-HF, NI	34	136-4395-03	1	Latch-Deck, LH
25	132-1429	2	Sensor-Trigger	35	136-4394-03	1	Latch-Deck, RH
26	3230-16	4	Screw-CARR	36	48-7081	2	Grip-Plastic
27	27-0410	2	Screw-Shoulder	37	340-82	2	Fitting-Elbow, 90 DEG
28	131-4305	2	Pin	37:1	237-42	1	O-Ring
29	139-0956	2	HYD Cylinder ASM	37:2	237-21	1	O-Ring
30	115-5300	2	Proximity Switch ASM	38	340-77	2	Fitting-Elbow, 90 DEG
30:1	117-3207	2	Nut-Hex	38:1	237-22	1	O-Ring
30:2	117-3208	2	Washer-Lock, Internal Tooth	38:2	237-42	1	O-Ring
31	120-9000-03	1	Crossmember	39	132-1421	1	Plate-Pivot, LH
32	3296-45	4	Nut-Hex	40	132-1422	1	Plate-Pivot, RH
33	104-3577	4	Washer	41	3290-412	6	Rivet-Blind

● Not serviced separately

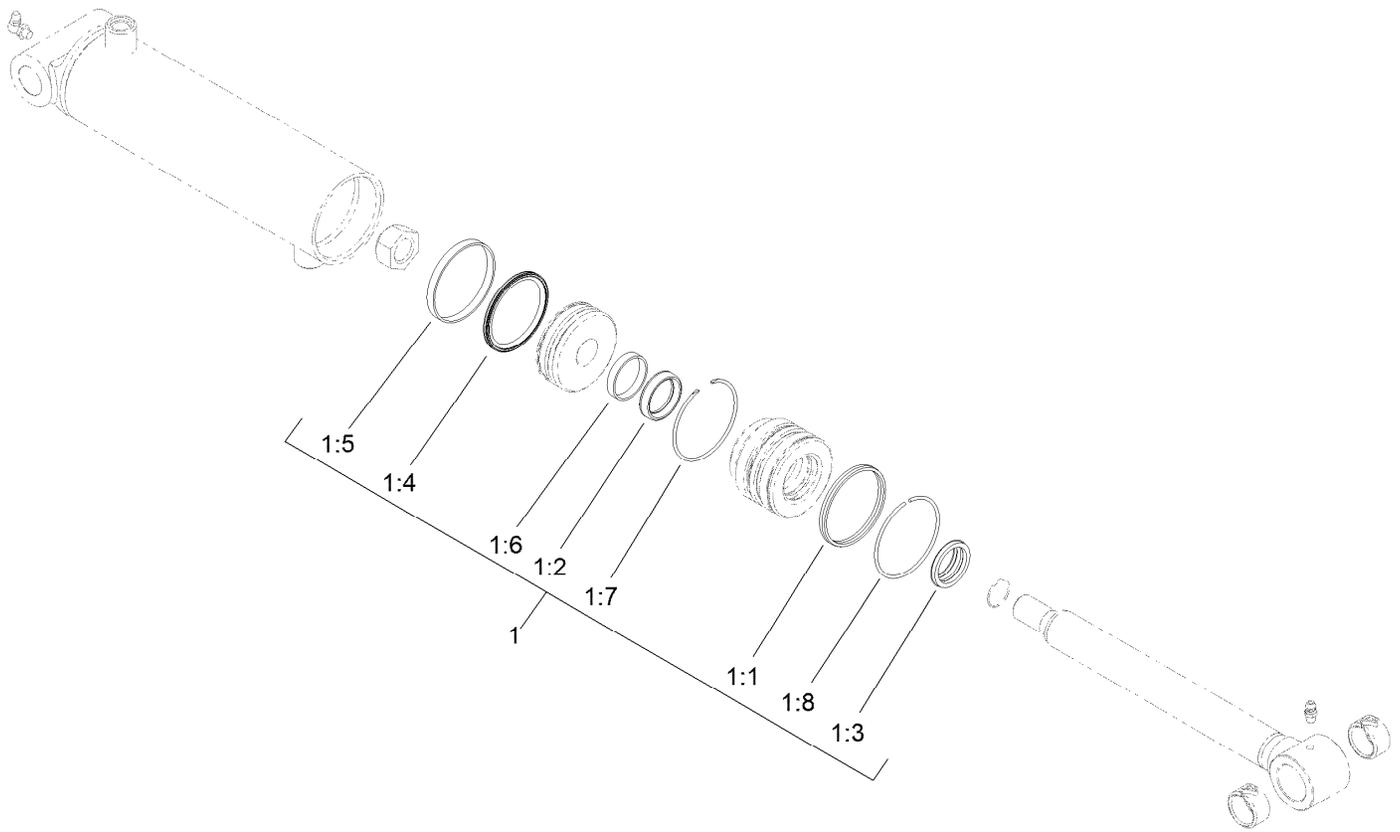

Hydraulic Cylinder Assembly No. 139-0956

<i>Ref.</i>	<i>Part Number</i>	<i>Qty.</i>	<i>Description</i>
1	139-0994	1	Seal Repair Kit
1:1		1	Seal-Dual ●
1:2		1	Seal-Rod ●
1:3		1	Wiper-Rod ●
1:4		1	Seal-Piston ●
1:5		1	Ring-Wear, Piston ●
1:6		1	Ring-Wear, Rod ●
1:7		1	Ring-Retaining, Internal ●
1:8		1	Ring-Retaining, External ●

● Not serviced separately

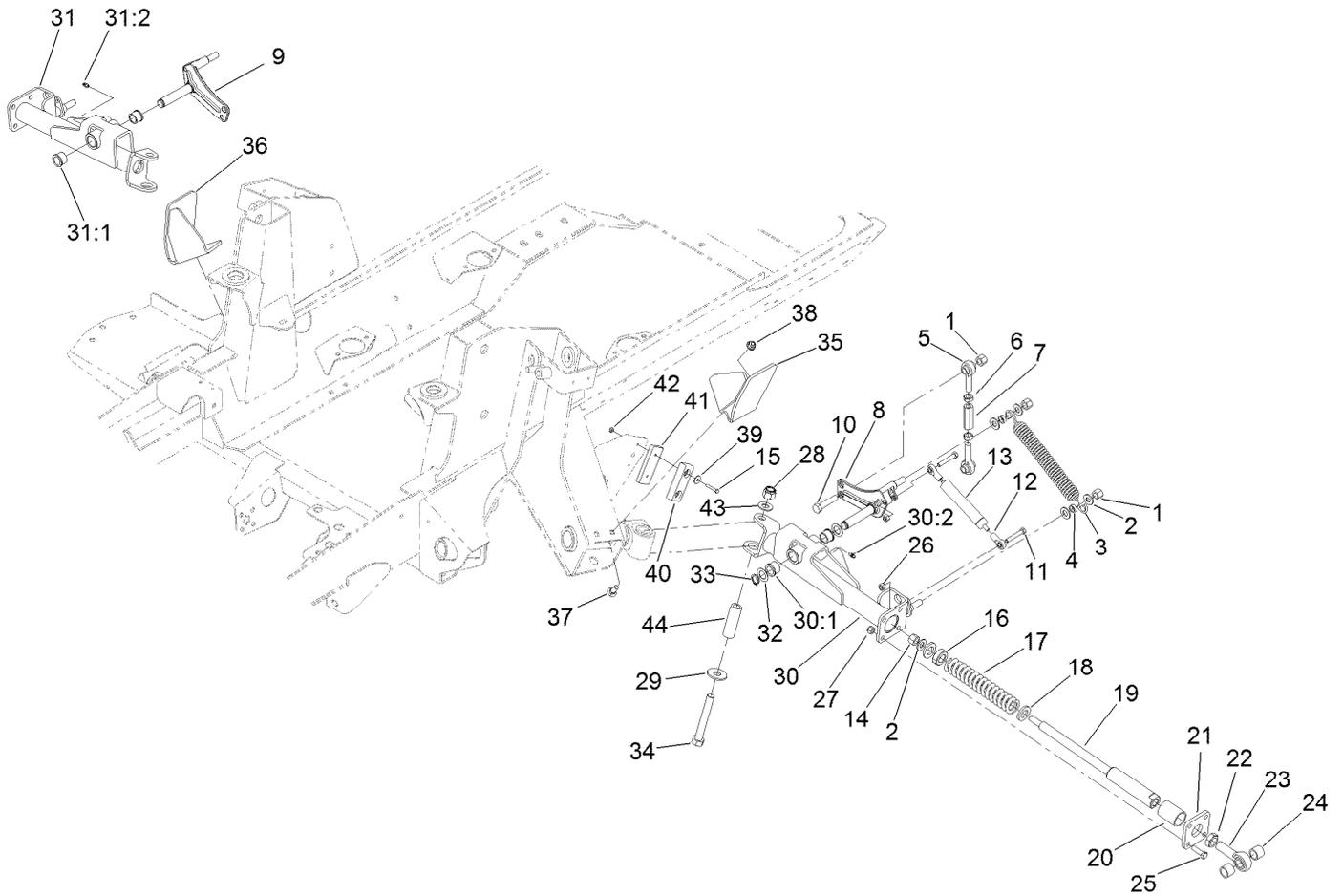

Impact Arm Assembly

Ref.	Part Number	Qty.	Description	Ref.	Part Number	Qty.	Description
1	3296-23	6	Nut-Lock, NI	22	3220-7	2	Nut-Jam
2	3256-26	10	Washer-Flat	23	105-2806	2	End-Rod
3	104-7520	2	Spring-Damper	24	136-0077	4	Spacer
4	104-7521	4	Bushing	25	323-7	8	Screw-HH
5	105-2808	4	End-Rod	26	3296-29	4	Nut-Lock, NI
6	3220-5	4	Nut-Jam	27	3296-39	8	Nut-Lock, NI
7	105-2809	2	Tube-Link	28	3296-53	2	Nut-Lock, NI
8	114-2717	1	Crank-Bell, LH	29	3256-7	2	Washer-Flat
9	114-2716	1	Crank-Bell, RH	30	120-8884	1	LH Rear Arm ASM
10	325-9	2	Screw-HH	30:1	256-113	2	Bushing-Flange
11	322-10	4	Screw-HH	30:2	302-5	1	Fitting-Grease
12	104-8331	4	End-Rod, Spherical	31	120-8883	1	RH Rear Arm ASM
13	105-3249	2	Damper	31:1	256-113	2	Bushing-Flange
14	3296-23	2	Nut-Lock, NI	31:2	302-5	1	Fitting-Grease
15	3290-360	4	Screw-HH	32	3-6498	4	Washer-Thrust
16	105-4552	2	Bearing-Plastic	33	32120-93	2	Ring-Retaining
17	100-8138	2	Spring-Compression	34	327-23	2	Screw-HH
18	105-4551	4	Washer-Flat	35	120-8856-03	1	Bracket-Roller, LH
19	105-4548	2	Shaft-Spring	36	120-8874-03	1	Bracket-Roller, RH
20	105-4550	2	Bushing-Straight	37	3231-2	4	Bolt-CARR
21	105-2807-03	2	Plate	38	104-8301	4	Nut-HF, NI

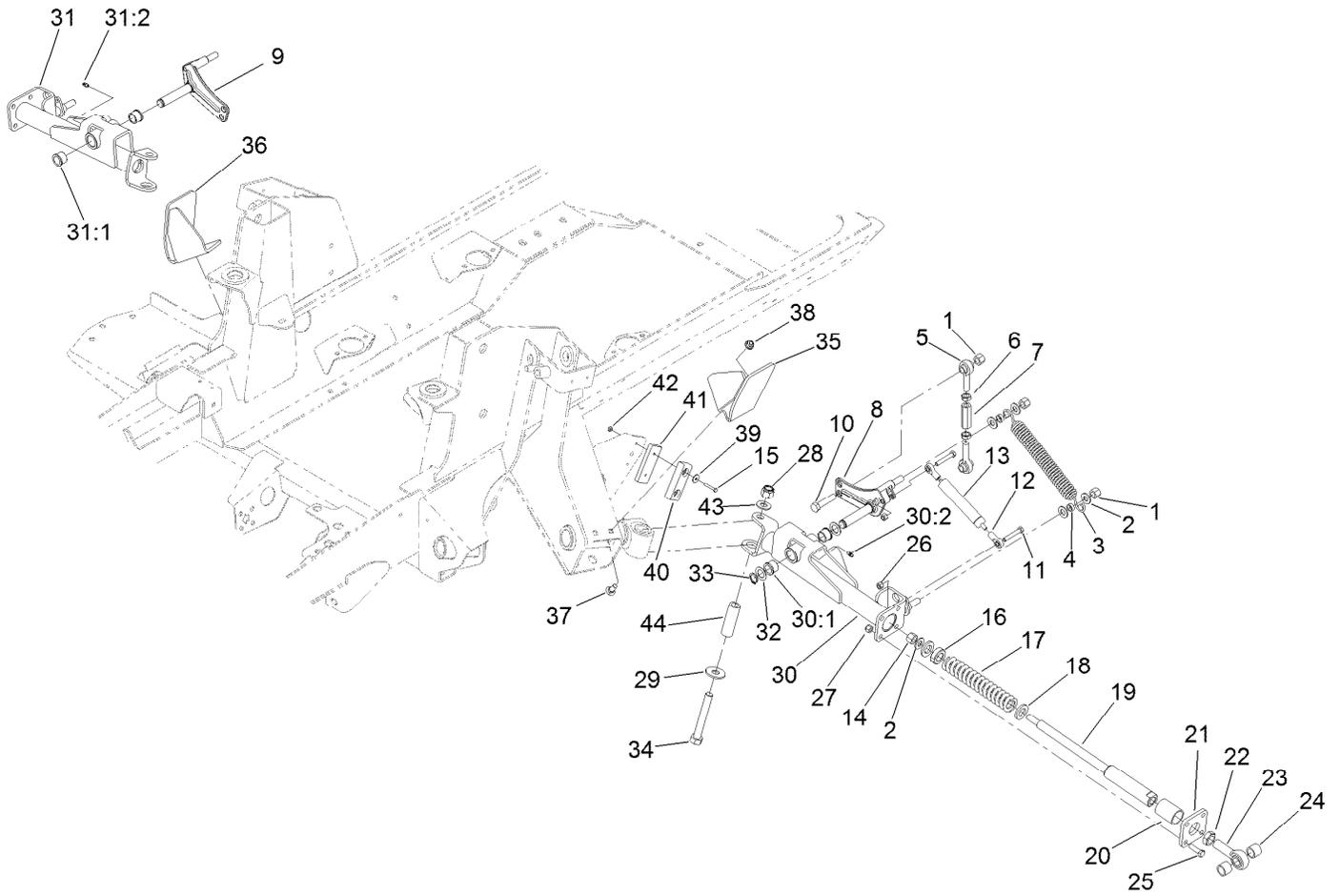

Impact Arm Assembly (continued)

<i>Ref.</i>	<i>Part Number</i>	<i>Qty.</i>	<i>Description</i>	<i>Ref.</i>	<i>Part Number</i>	<i>Qty.</i>	<i>Description</i>
39	3256-61	4	Washer-Flat	42	3296-2	4	Nut-Lock, NI
40	86-5350	2	Bumper-Rubber	43	3256-27	2	Washer-Flat
41	119-8308-03	2	Plate	44	94-6604	2	Tube-Spacer

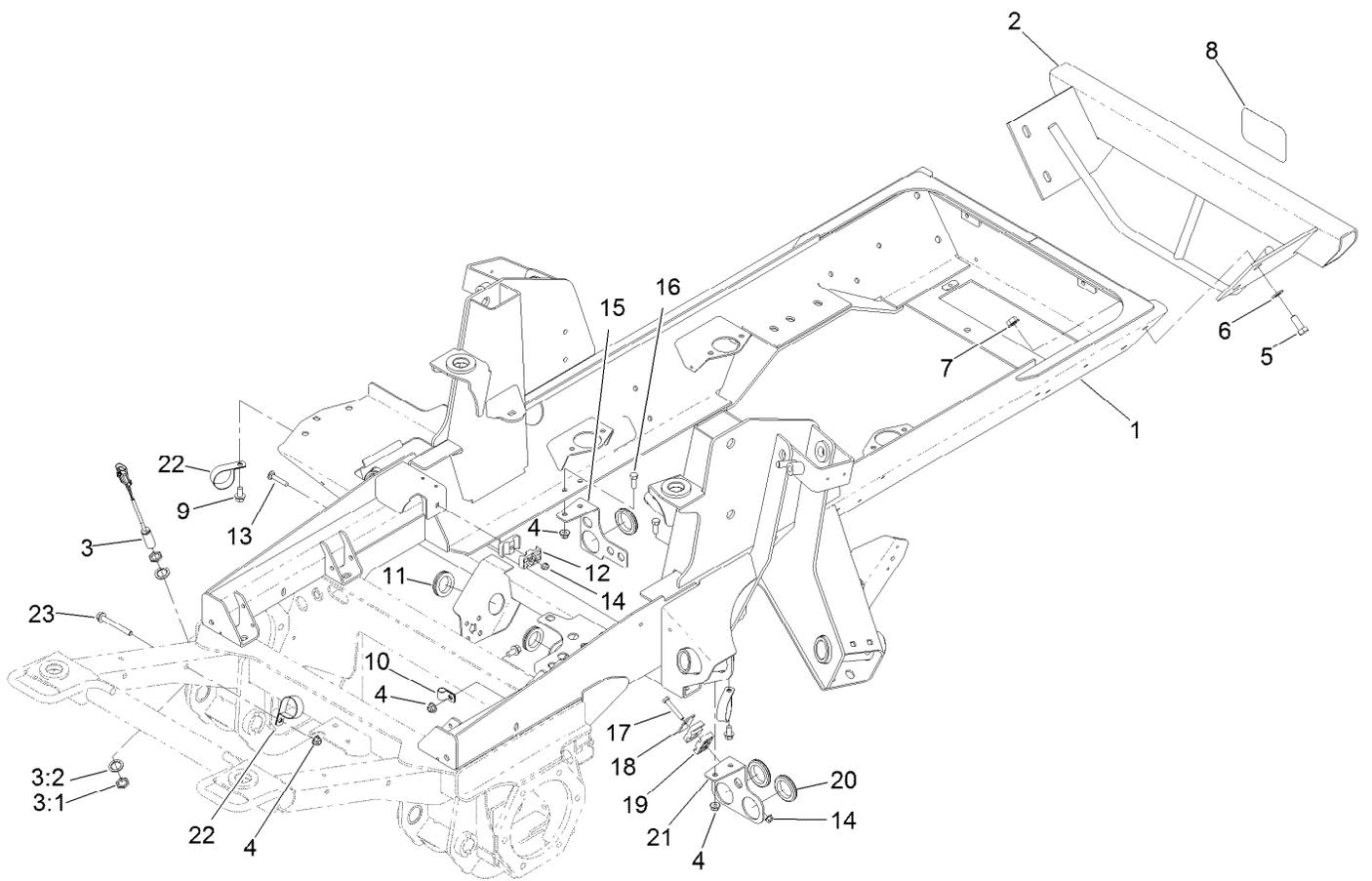

Frame, Bumper and Proximity Sensor Assembly

<i>Ref.</i>	<i>Part Number</i>	<i>Qty.</i>	<i>Description</i>	<i>Ref.</i>	<i>Part Number</i>	<i>Qty.</i>	<i>Description</i>
1	120-4010-03	1	Frame	12	56-7971	2	Clamp-Tube
2	120-8919-03	1	Bumper	13	3230-5	1	Bolt-CARR
3	115-0282	1	Proximity Sensor ASM	14	104-8300	2	Nut-HF, NI
3:1	117-3207	2	Nut-Hex	15	121-1508-03	1	Bracket-Bulkhead
3:2	117-3208	2	Washer-Lock, Internal Tooth	16	323-6	4	Screw-HH
4	104-8301	6	Nut-HF, NI	17	322-10	1	Screw-HH
5	325-5	4	Screw-HH	18	69-9760	1	Plate-Cover
6	3256-26	4	Washer-Flat	19	56-7976	2	Clamp-Tube
7	32128-23	4	Nut-HF	20	240-2	3	Grommet-Rubber
8	105-8278	1	Decal	21	121-1481-03	1	Plate-Mount, Bulkhead (LH)
9	3234-1	3	Screw-HHF	22	2412-147	3	Clamp-R
10	2412-138	1	R-Clamp	23	3234-41	1	Screw-HHF
11	240-7	2	Grommet-Rubber				

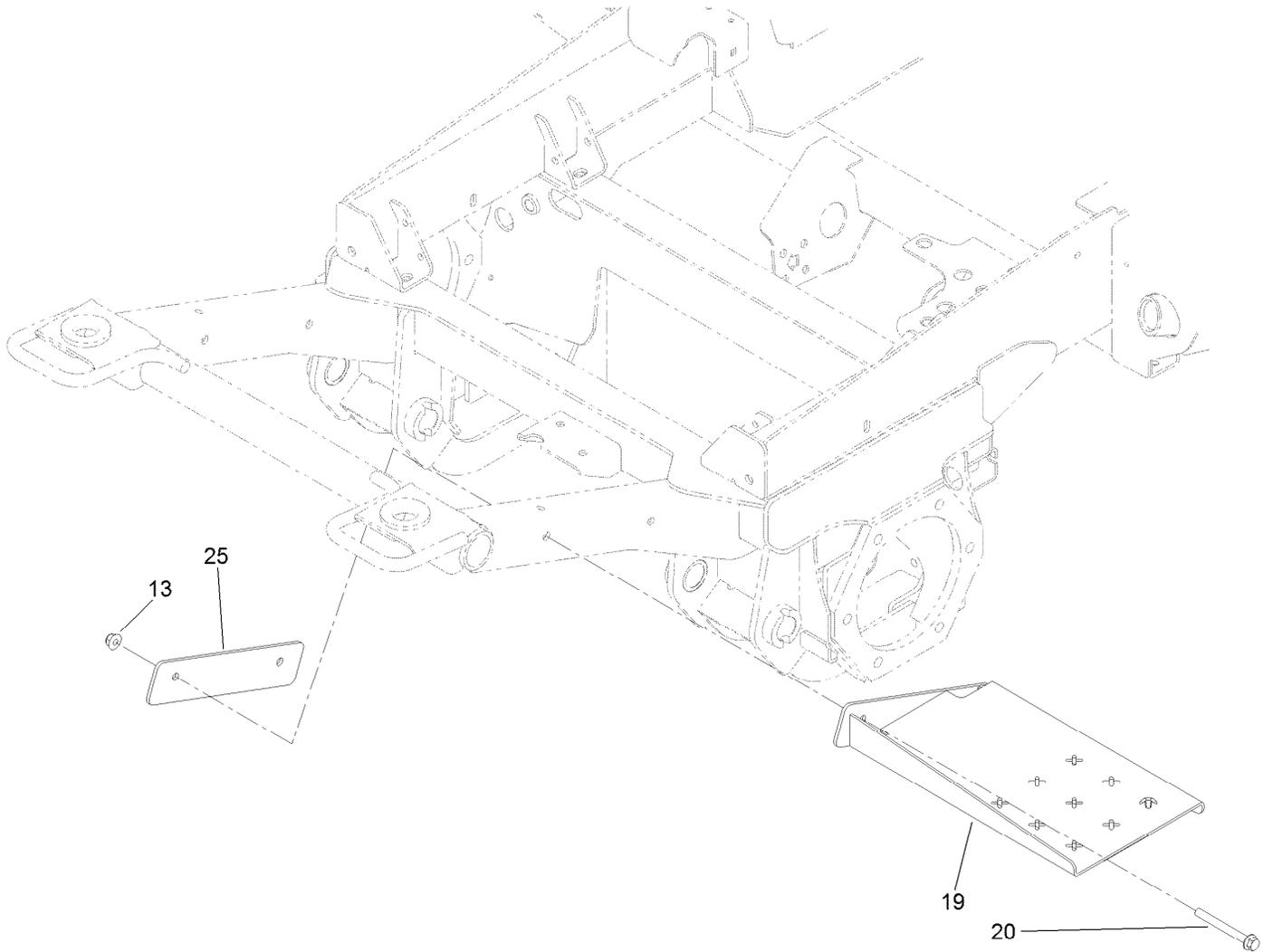

Cab Step Assembly

<i>Ref.</i>	<i>Part Number</i>	<i>Qty.</i>	<i>Description</i>
13	104-8301	2	Nut-HF, NI
19	121-1739-03	1	Step
20	116-4701	2	Screw-HHF
25	120-9022-03	1	Support-Step

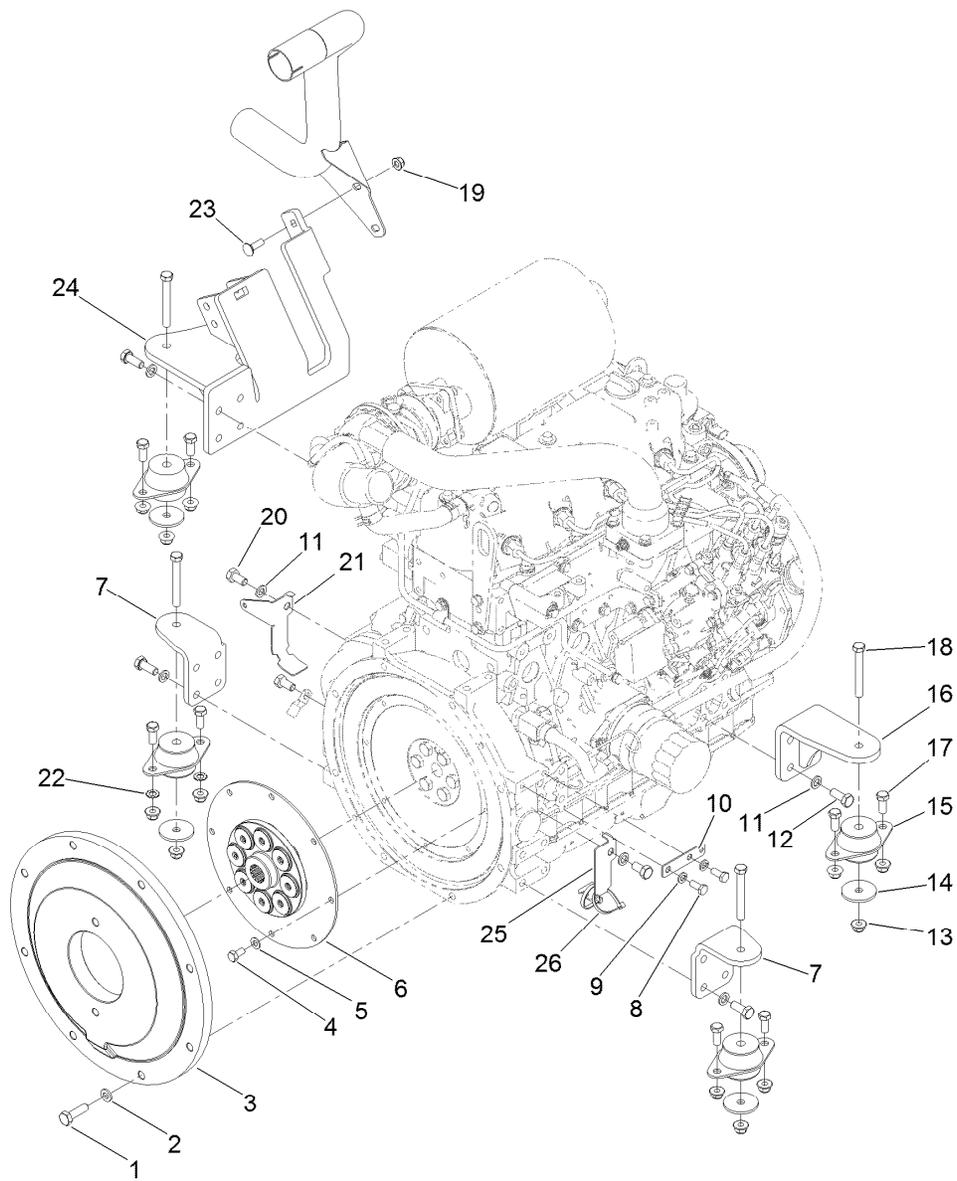

Flywheel and Motor Mount Assembly

Ref.	Part Number	Qty.	Description
1	117-5663	8	Screw-HH
2	107-1413	8	Washer-Hardened
3	132-6120-03	1	Plate-Flywheel
4	99-5132	8	Bolt
5	87-7510	8	Washer-Flat
6	132-6121	1	Coupling-Flywheel
7	120-4066-03	2	Mount-Motor, Front
8	33114-020	2	Screw-HH
9	3253-4	2	Washer-Lock
10	121-5636	1	Tab-Harness
11	48-9590	18	Washer-Lock
12	33115-025	16	Screw-HH
13	104-8301	12	Nut-HF, NI

Ref.	Part Number	Qty.	Description
14	63-7400	4	Washer-Rebound
15	53-9682	4	Mount-Engine
16	120-4068-03	1	Mount-Motor
17	323-5	8	Screw-HH
18	323-14	4	Screw-HH
19	104-8300	2	Nut-HF, NI
20	33115-020	3	Screw-HH
21	139-0992	1	Bracket-Harness, RH
22	3255-9	2	Washer-Lock
23	3230-2	2	Bolt-CARR
24	127-3722-03	1	Mount-Motor
25	139-0993	1	Bracket-Harness, LH
26	3290-378	2	Tie-Cable

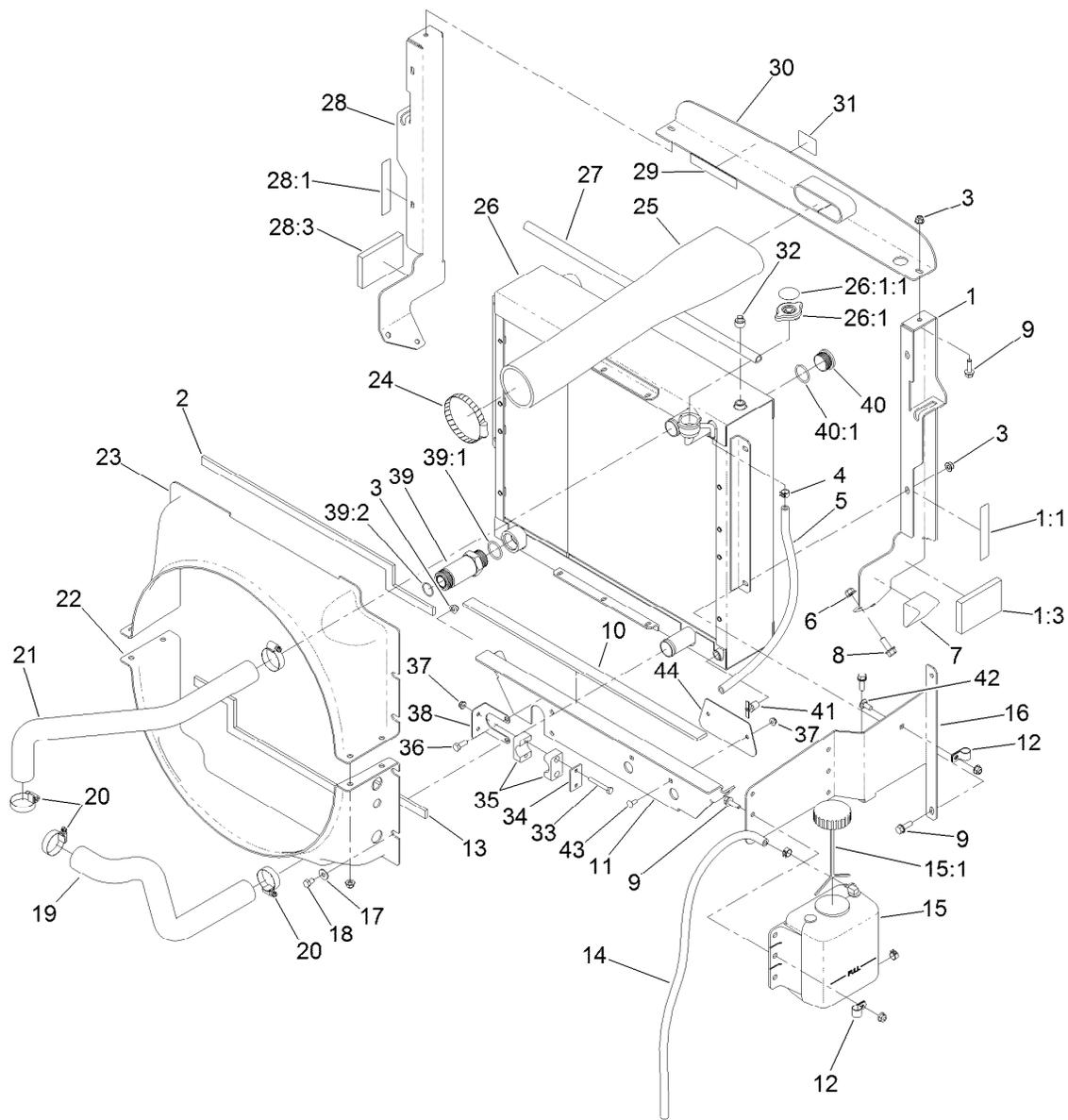

Radiator Assembly

Ref.	Part Number	Qty.	Description	Ref.	Part Number	Qty.	Description
1	121-1479	1	LH Radiator Support ASM	19	121-1746	1	Hose-Radiator, Lower
1:1	93-7272	1	Decal-Warning	20	2412-111	4	Clamp-Hose, W/Liner
1:3	100-2196	1	Pad-Foam	21	121-1747	1	Hose-Radiator, Upper
2	121-1684	1	Foam-Radiator	22	121-1517	1	Shroud-Radiator, Lower
3	104-8300	15	Nut-HF, NI	23	121-1515	1	Shroud-Radiator, Upper
4	92-2379	3	Clamp-Hose	24	2412-110	1	Clamp-Band/Screw
5	110-4112	1	Hose-Fuel	25	121-1474	1	Hose-Inlet, Air Cleaner
6	104-8301	6	Nut-HF, NI	26	132-6161	1	Radiator/Oil Cooler
7	93-5954	2	Plug-Foam	26:1	115-7766	1	Cap-Radiator
8	3234-11	6	Screw-HHF	26:1:1	106-6755	1	Decal-Cap, Radiator
9	3234-29	12	Screw-HHF	27	114-3828	1	Seal-Bulb
10	104-2226	1	Strip-Foam	28	121-1478	1	RH Radiator Support ASM
11	139-0952-03	1	Support-Radiator	28:1	93-7272	1	Decal-Warning
12	92-6064	2	Clamp-R	28:3	100-2196	1	Pad-Foam
13	121-1685	1	Foam-Radiator, Lower	29	93-7272	1	Decal-Warning
14	110-9662	1	Hose-Fuel	30	136-4364-03	1	Bracket-Intake
15	120-5571	1	Coolant Reservoir ASM	31	117-4765	1	Decal-Starting Fluid
15:1	87-7050	1	Cap-Reservoir	32	281-13	1	Plug-Pipe
16	130-0603-03	1	Bracket-Mount, Bottle	33	321-11	2	Screw-HH
17	3256-3	8	Washer-Flat	34	114-4902	1	Plate-Cover
18	322-1	8	Screw-HH	35	114-4901	1	Clamp

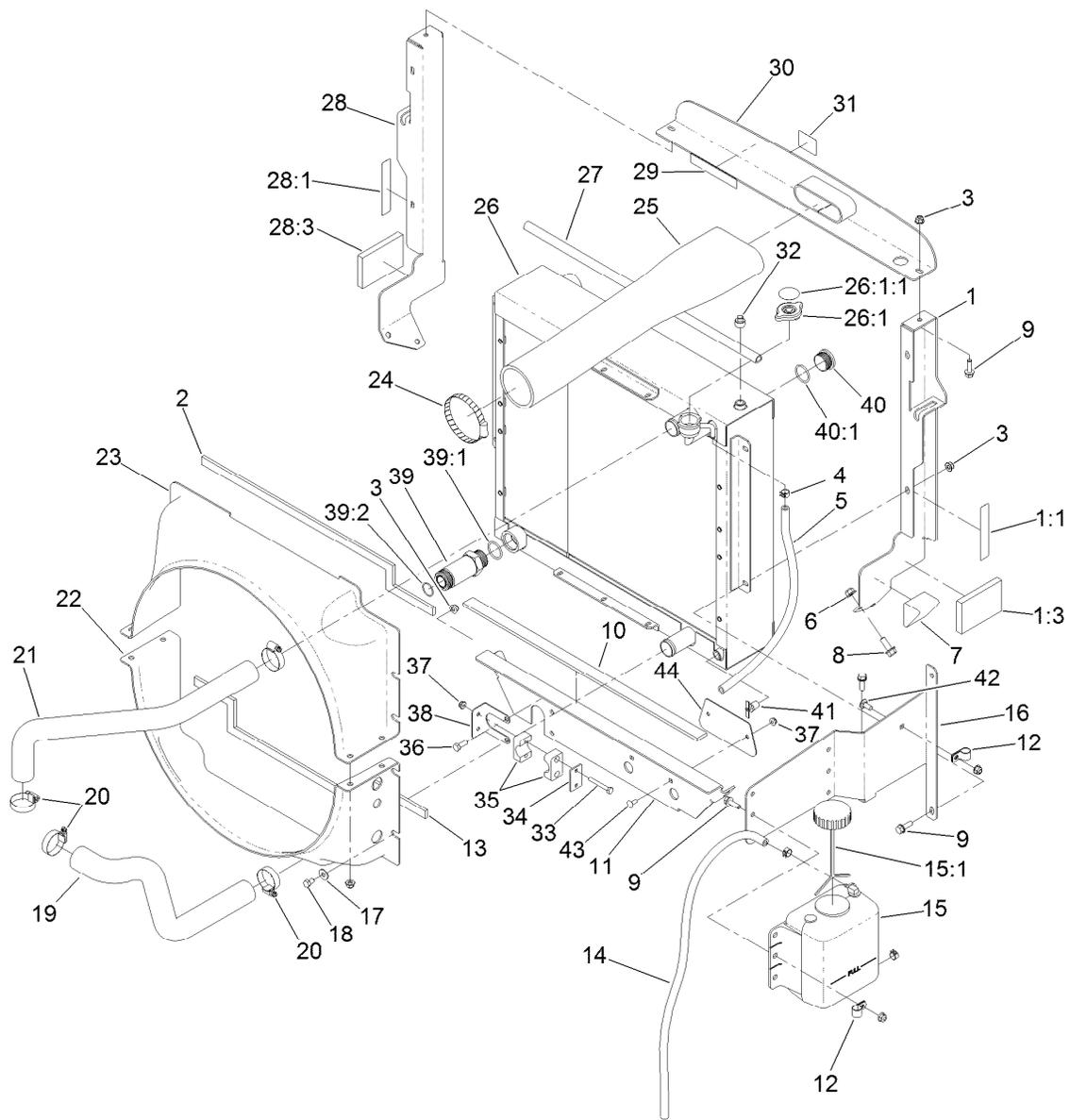

Radiator Assembly (continued)

<i>Ref.</i>	<i>Part Number</i>	<i>Qty.</i>	<i>Description</i>	<i>Ref.</i>	<i>Part Number</i>	<i>Qty.</i>	<i>Description</i>
36	322-4	2	Screw-HH	40	106-2030	1	Plug-Hex, Hollow
37	104-7201	4	Nut-HF, NI	40:1	237-146	1	O-Ring
38	120-8984	1	Bracket-Clamp	41	304-46	1	Draincock
39	100-5565	1	Fitting-STR	42	3230-23	1	Bolt-CARR
39:1	237-146	1	O-Ring	43	3229-11	2	Screw-CARR
39:2	340-65	1	O-Ring	44	139-0989-03	1	Plate

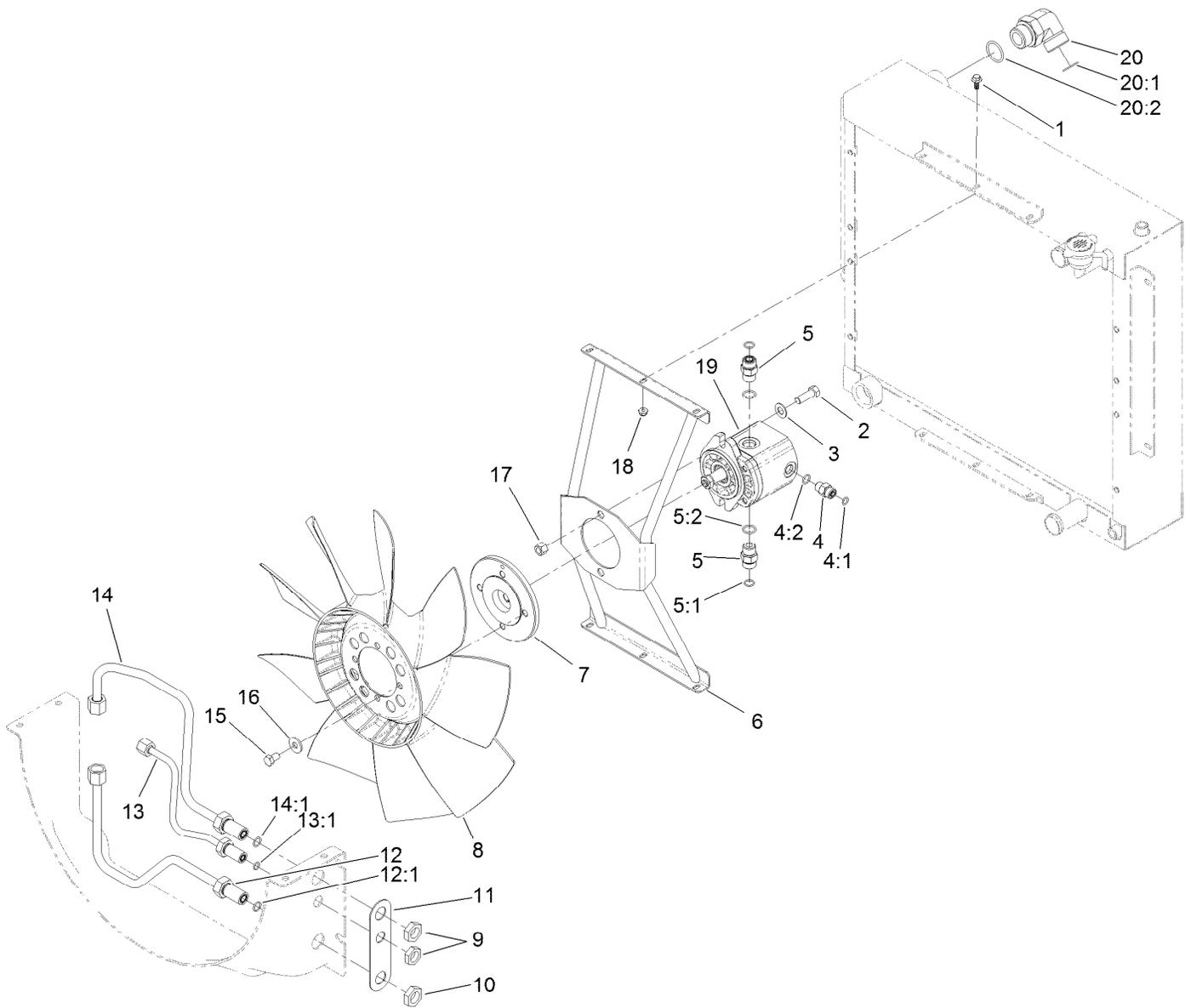

Fan Mounting and Hardline Assembly

Ref.	Part Number	Qty.	Description
1	99-6810	6	Screw-HHF
2	324-5	2	Screw-HH
3	3256-25	2	Washer-Flat
4	340-2	1	Fitting-Straight
4:1	237-22	1	O-Ring
4:2	237-42	1	O-Ring
5	340-4	2	Fitting-Straight
5:1	237-30	1	O-Ring
5:2	237-79	1	O-Ring
6	137-5594	1	Mount-Fan
7	117-2364	1	Hub-Fan
8	114-3825	1	Fan
9	340-70	1	Nut-Lock
10	340-127	2	Nut-Bulkhead
11	121-1518	1	Shim-Support

Ref.	Part Number	Qty.	Description
12	137-5554	1	Tube ASM
12:1	237-30	1	O-Ring
13	137-5555	1	Tube ASM
13:1	237-22	1	O-Ring
14	137-5553	1	Tube ASM
14:1	237-30	1	O-Ring
15	115-8486	4	Screw-HH
16	80-6990	4	Washer-Hardened
17	3296-48	2	Nut-Hex
18	104-7201	6	Nut-HF, NI
19	137-5571	1	Hydraulic Motor ASM
20	340-129	1	Fitting-Elbow, 90 DEG
20:1	237-146	1	O-Ring
20:2	340-65	1	O-Ring

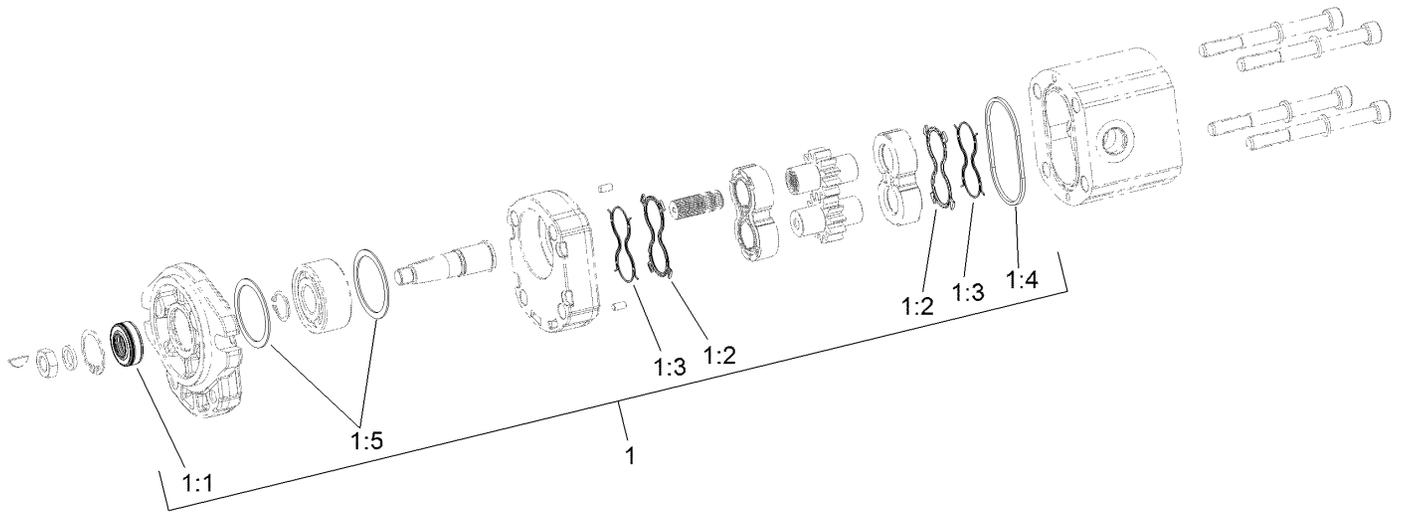

Hydraulic Motor Assembly No. 137-5571

<i>Ref.</i>	<i>Part Number</i>	<i>Qty.</i>	<i>Description</i>
1	139-1019	1	Seal Kit
1:1		1	Seal-Shaft ●
1:2		2	Seal-Plate, Balancing ●
1:3		2	Seal-Anti Extrusion ●
1:4		1	O-Ring (Housing) ●
1:5		2	Seal-Square ●

● Not serviced separately

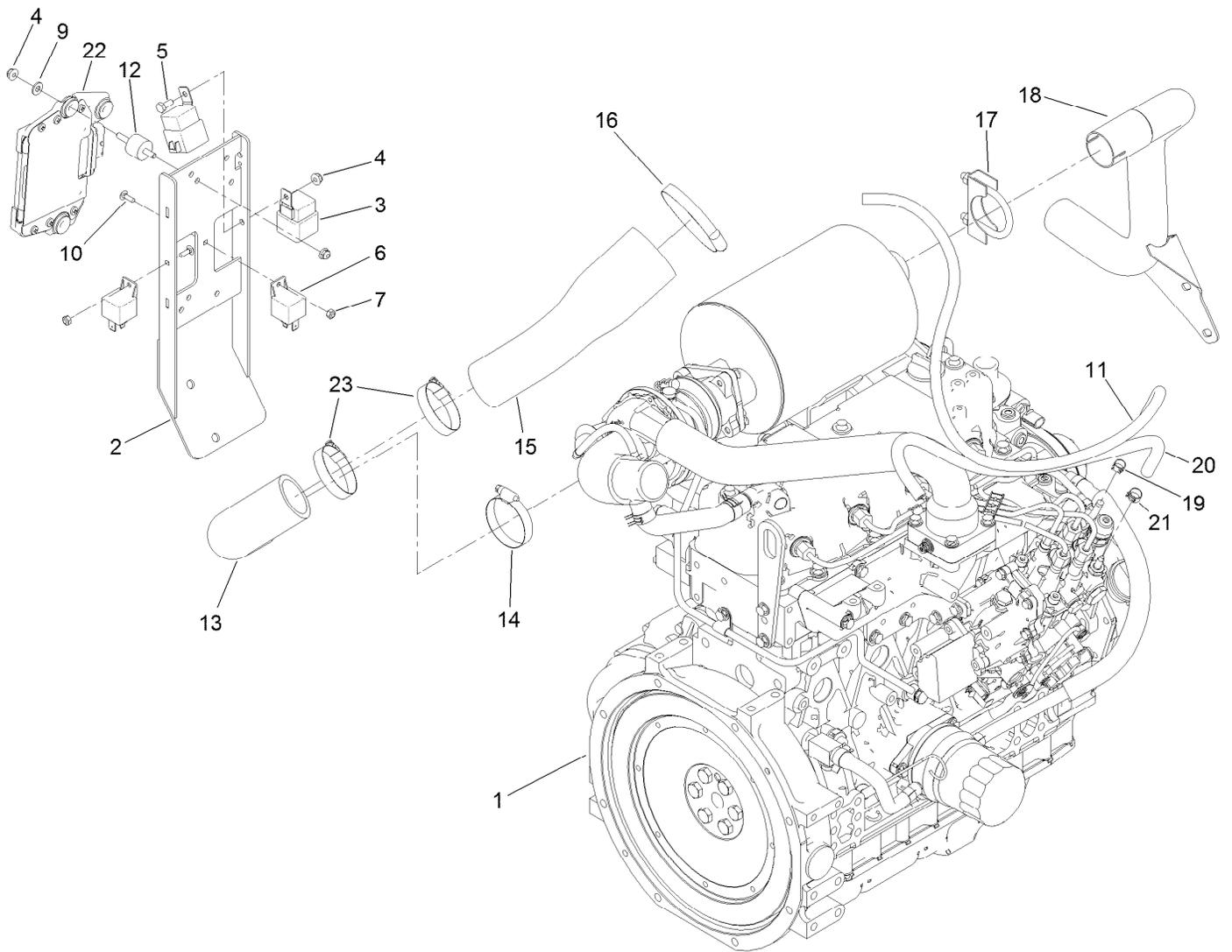

Engine, Intake and Exhaust Assembly

<i>Ref.</i>	<i>Part Number</i>	<i>Qty.</i>	<i>Description</i>	<i>Ref.</i>	<i>Part Number</i>	<i>Qty.</i>	<i>Description</i>
1	138-6918	1	Engine-Yanmar	13	121-1589	1	Hose-Outlet, Air Cleaner
2	136-4430-03	1	Mount-Controller	14	2412-130	1	Clamp-Hose
3	99-7430	2	Relay-Mini	15	121-1590	1	Hose-Outlet, Air Cleaner
4	104-7201	7	Nut-HF, NI	16	2412-110	1	Clamp-Band/Screw
5	321-3	1	Screw-HH	17	18-2130	1	Clamp
6	99-7435	2	Relay	18	121-1616	1	Pipe-Exhaust
7	3296-2	2	Nut-Lock, NI	19	2412-98	1	Clamp-Hose
9	3256-22	3	Washer-Flat	20	108-3284	1	Hose-Fuel
10	1-807533	2	Bolt-CARR	21	92-2379	1	Clamp-Hose
11	110-5702	1	Hose-Fuel	22	135-4281	1	Ecu
12	132-1356	3	Mount-Isolator	23	2412-130	2	Clamp-Hose

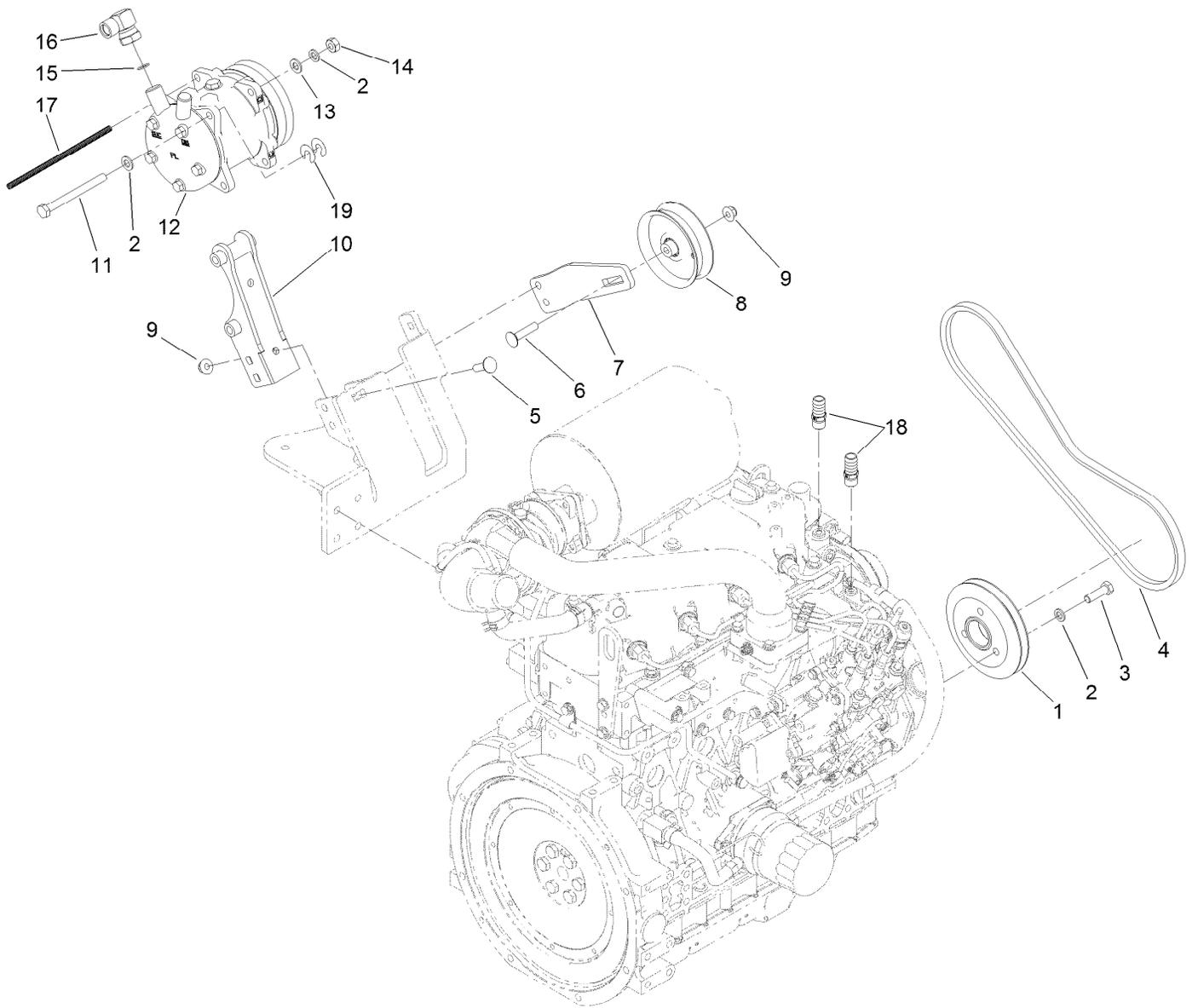

Air Conditioner Compressor Assembly

<i>Ref.</i>	<i>Part Number</i>	<i>Qty.</i>	<i>Description</i>	<i>Ref.</i>	<i>Part Number</i>	<i>Qty.</i>	<i>Description</i>
1	121-8177	1	Pulley-Single	11	33115-110	2	Screw-HH
2	48-9590	5	Washer-Lock	12	119-0103	1	Compressor
3	33115-035	3	Screw-HH	13	33095-00	4	Washer-Flat
4	110-6254	1	Belt-V	14	33015-00	2	Nut-Hex
5	3231-25	5	Bolt-CARR	15	117-2780	1	O-Ring
6	3231-5	1	Screw-CARR	16	119-0128	1	Fitting-Elbow, 90 DEG
7	127-3727-03	1	Mount-Pulley	17	115-8882	1	Conduit-Convolute
8	98-3095	1	Pulley-Idler	18	117-9410	2	Fitting-Straight
9	104-8301	6	Nut-HF, NI	19	119-7734	4	Shim
10	127-3726-03	1	Mount-Compressor				

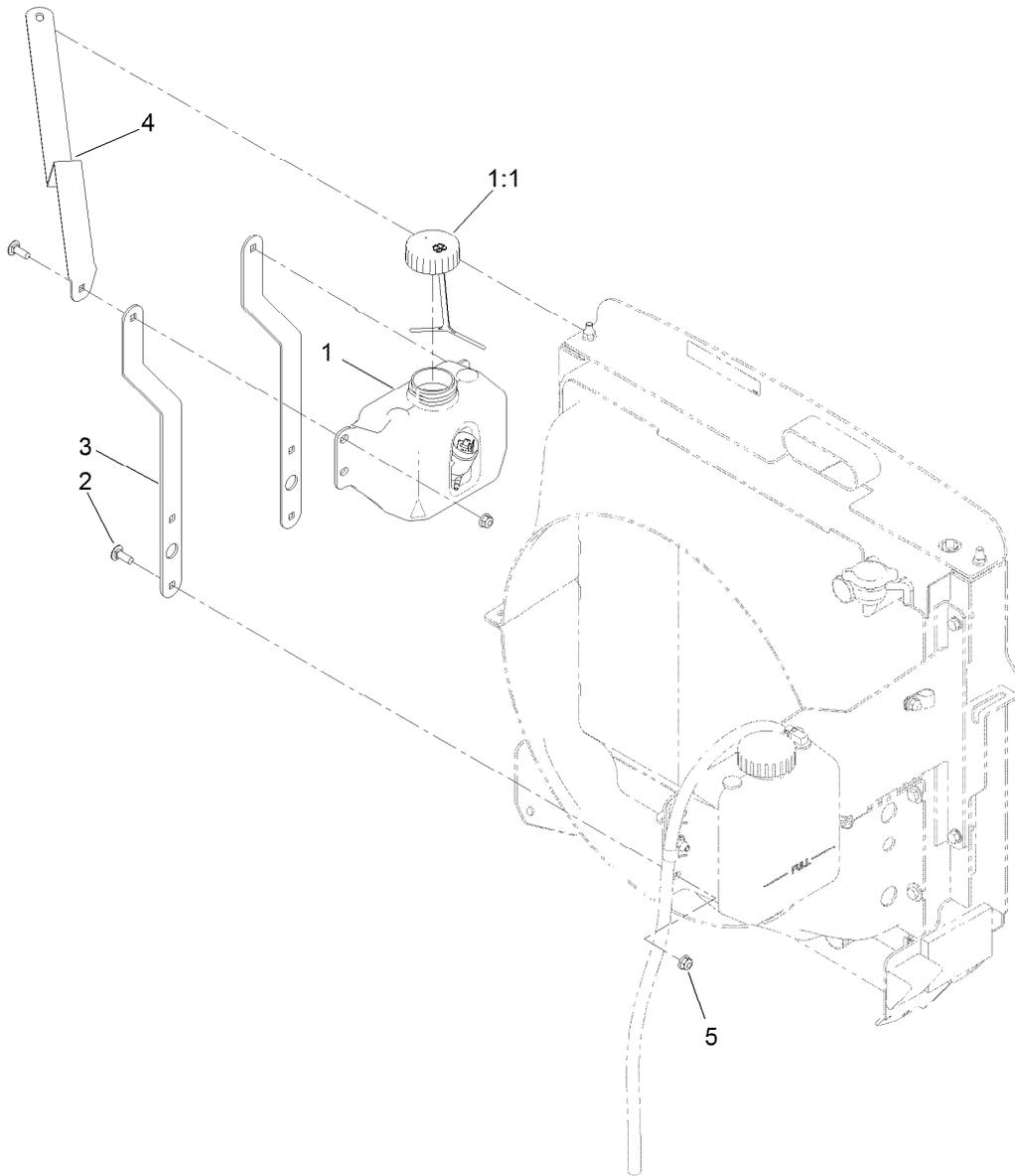

Washer Fluid Bottle Assembly

<i>Ref.</i>	<i>Part Number</i>	<i>Qty.</i>	<i>Description</i>
1	138-2702	1	Tank-Fluid, Washer
1:1	125-5258	1	Lid-Tank, Washer Fluid
2	3230-10	6	Bolt-CARR
3	130-0604-03	2	Strap-Bottle, Washer Fluid
4	130-0605-03	1	Support-Bottle, Washer Fluid
5	104-8300	6	Nut-HF, NI

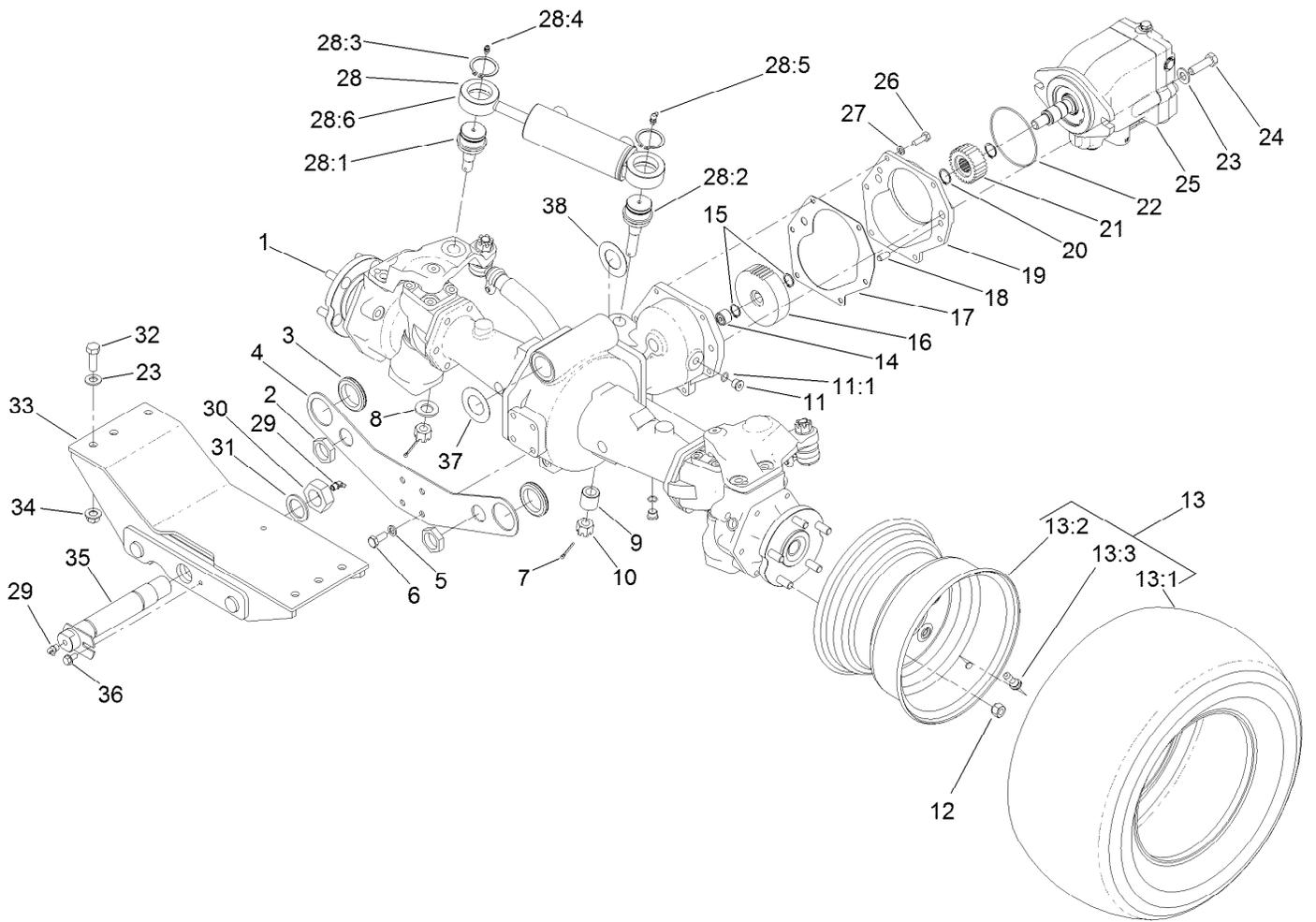

Rear Axle and Steering Cylinder Assembly

Ref.	Part Number	Qty.	Description	Ref.	Part Number	Qty.	Description
1	110-4750	1	Drive Axle ASM	15	32120-15	2	Ring-Snap, EXT
2	340-126	2	Nut-Bulkhead	16	100-3053	1	Gear-45 Tooth
3	240-2	2	Grommet-Rubber	17	106-1140	1	Gasket
4	120-9069-03	1	Plate-Mount, Bulkhead	18	104-2353	2	Pin-Dowel
5	43-0090	4	Screw-HH	19	95-7541	1	Plate-Cover
6	48-9590	4	Washer-Lock	20	32120-76	2	Ring-Snap, EXT
7	3272-12	2	Pin-Cotter	21	104-0755	1	Pinion-27 Tooth
8	92-5836	1	Washer	22	237-166	1	O-Ring
9	100-3796	1	Spacer-Joint, Ball	23	3256-26	8	Washer-Flat
10	32136-14	2	Nut-Hst	24	325-7	2	Screw-HH
11	353-989	2	Plug-Hex, Hollow	25	120-8814	1	HYD Motor ASM
11:1	237-42	1	O-Ring	26	33114-025	6	Screw-HH
12	93-5268	10	Nut-Lug	27	3253-4	6	Washer-Lock
13		2	Tire And Wheel ASM ●	28	121-1535	1	Steering Cylinder ASM
13:1	120-8910	1	Tire-Off Road	28:1	106-6774	1	Joint-Ball
13:2	120-8909	1	Rim	28:2	100-3795	1	Joint-Ball
13:3	232-27	1	Stem-Valve	28:3	32151-104	2	Ring-Retaining, External
14	74-5700	1	Bearing-Needle, Roller	28:4	302-5	1	Fitting-Grease

● Not serviced separately

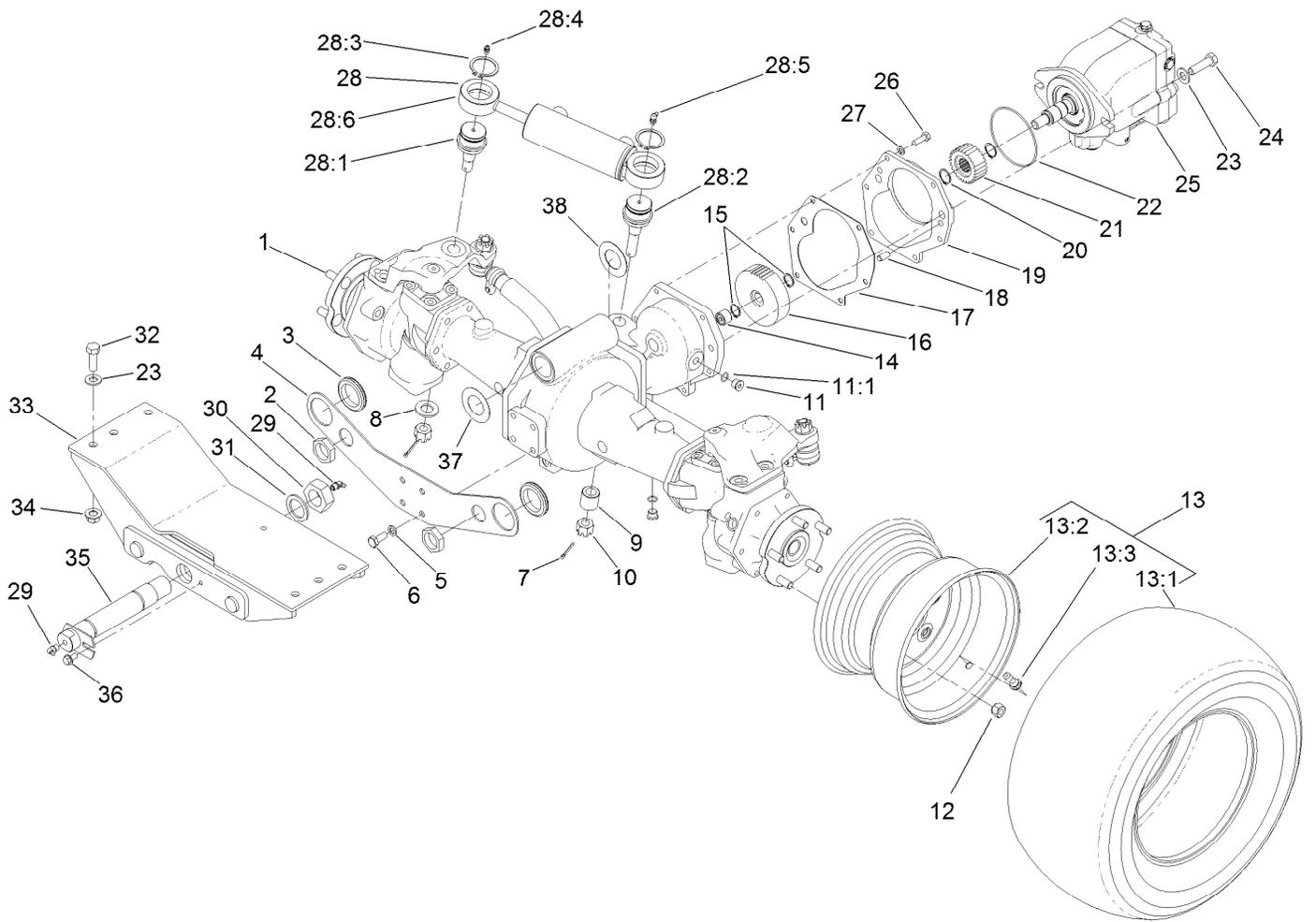

Rear Axle and Steering Cylinder Assembly (continued)

<i>Ref.</i>	<i>Part Number</i>	<i>Qty.</i>	<i>Description</i>	<i>Ref.</i>	<i>Part Number</i>	<i>Qty.</i>	<i>Description</i>
28:5	302-60	1	Fitting-Grease	33	130-2744-03	1	Mount-Rear
28:6	121-1534	1	HYD Steering Cylinder ASM	34	99-5107	6	Nut-Lock
29	302-33	2	Fitting-Grease	35	98-7077	1	Pin-Axle, Rear
30	3296-68	1	Nut-Lock, NI	36	32144-14	1	Screw-HWHTF
31	92-1765	1	Washer-Thrust	37	99-8431	2	Washer-Thrust
32	325-6	6	Screw-HH	38	99-8432	2	Washer-Thrust

● Not serviced separately

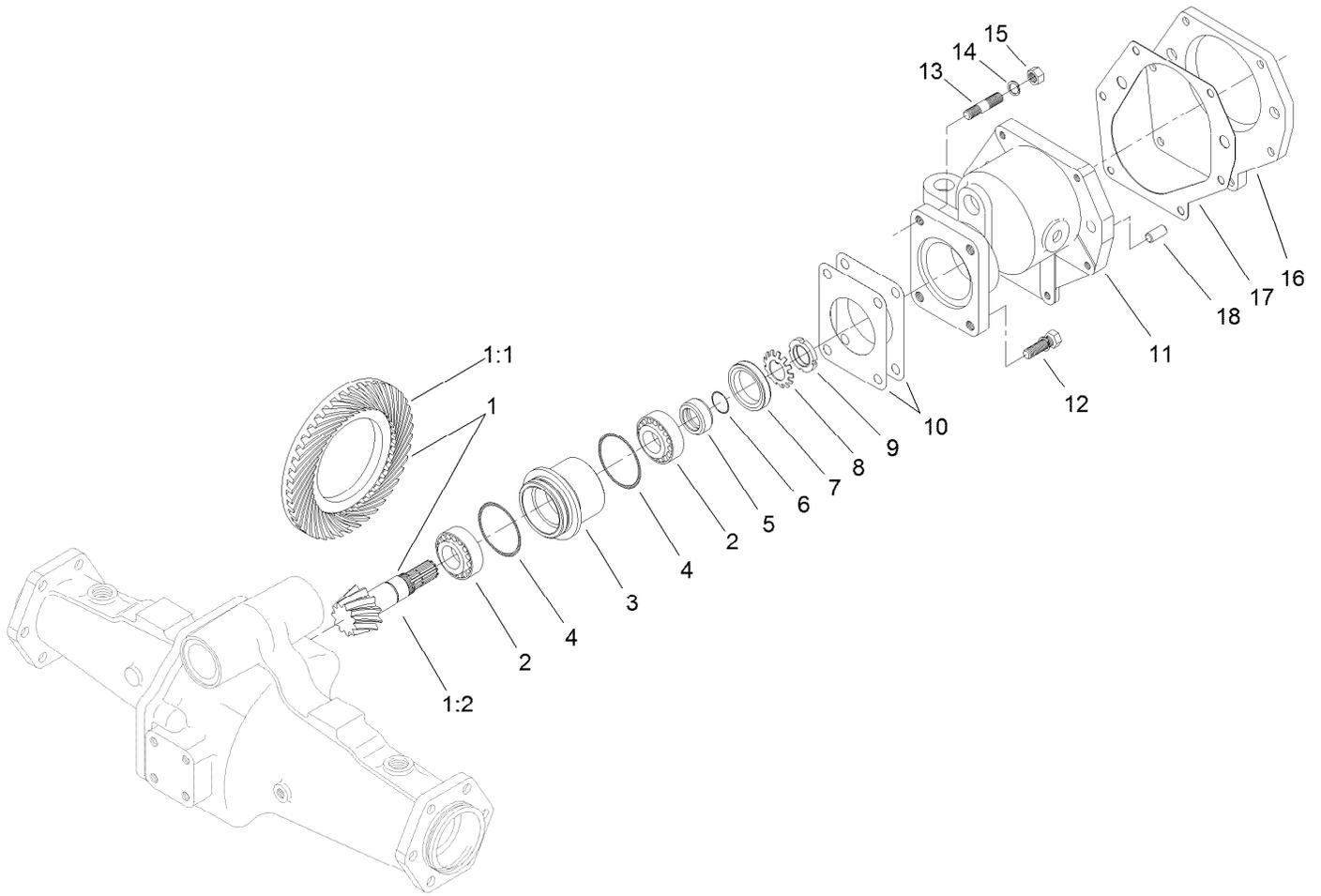

Bevel Pinion Shaft Assembly Rear Axle Assembly No. 110-4750

<i>Ref.</i>	<i>Part Number</i>	<i>Qty.</i>	<i>Description</i>
1	106-1093	1	Ring And Pinion Set
1:1	95-7504	1	Gear-43 Tooth, Bevel Spiral
1:2	106-1092	1	Pinion-Spiral, Bevel
2	99-7570	2	Bearing-Roller, Taper
3	95-7534	1	Case-Bearing
4	106-1065	2	O-Ring
5	99-7572	1	Collar-Seal, Oil
6	106-1066	1	O-Ring
7	99-7574	1	Seal-Oil
8	99-7559	1	Washer-Lock
9	99-7560	1	Nut-Lock

<i>Ref.</i>	<i>Part Number</i>	<i>Qty.</i>	<i>Description</i>
10	99-7550	2	Shim 0.1
10	99-7551	2	Shim 0.2
11	95-7533	1	Case-Gear
12	99-7575	2	Bolt
13	98-7735	2	Stud
14	99-7527	2	Washer-Spring
15	99-7526	2	Nut
16	95-7541	1	Plate-Cover
17	106-1140	1	Gasket
18	104-2353	2	Pin-Dowel

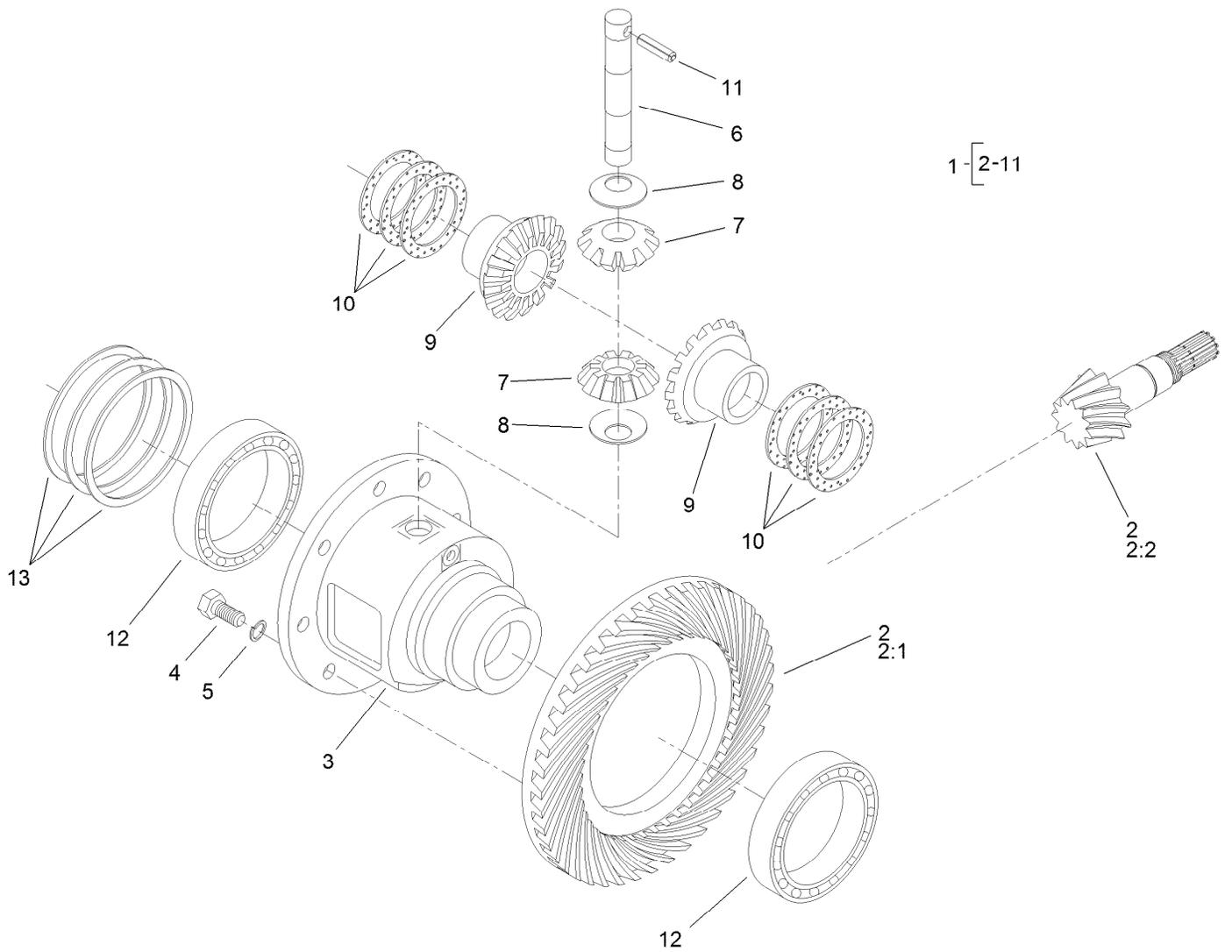

Differential Assembly Rear Axle Assembly No. 110-4750

<i>Ref.</i>	<i>Part Number</i>	<i>Qty.</i>	<i>Description</i>	<i>Ref.</i>	<i>Part Number</i>	<i>Qty.</i>	<i>Description</i>
1	95-7503	1	Differential ASM	9	99-7581	2	Gear-Differential
2	106-1093	1	Ring And Pinion Set	10	99-7582	2	Washer-Differential
2:1	95-7504	1	Gear-43 Tooth, Bevel Spiral	10	99-7583	2	Washer-Differential
2:2	106-1092	1	Pinion-Spiral, Bevel	10	99-7584	2	Washer-Differential
3	95-7502	1	Case-Differential	11	99-7588	1	Pin-Spring
4	99-7576	8	Bolt	12	99-7562	2	Bearing-Ball
5	3253-4	8	Washer-Lock	13	99-7585	2	Shim 0.1
6	99-7578	1	Shaft-Differential	13	99-7586	2	Shim 0.2
7	99-7579	2	Pinion-Differential	13	99-7587	2	Shim 0.4
8	99-7580	2	Washer-Differential				

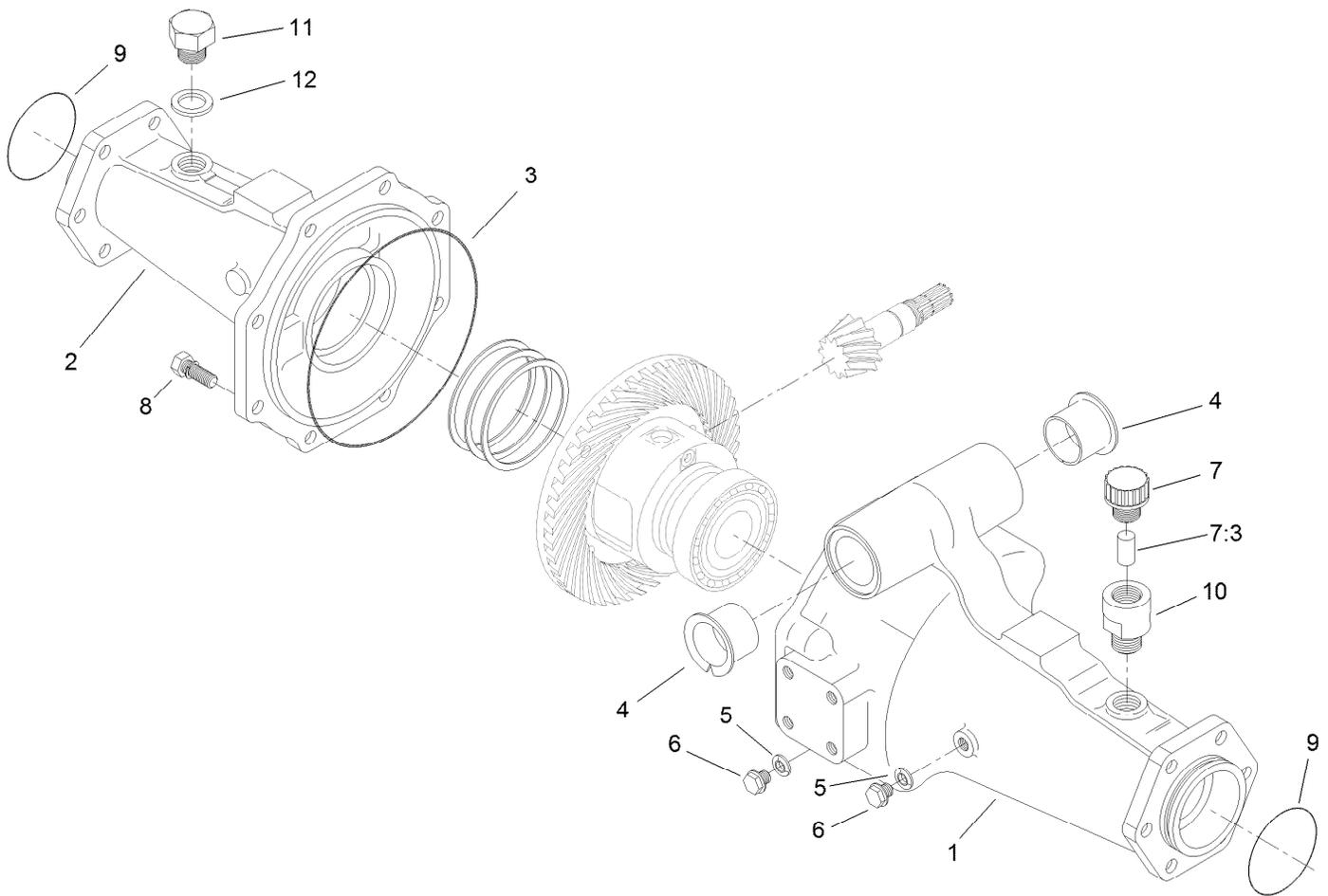

Axle Support Assembly Rear Axle Assembly No. 110-4750

<i>Ref.</i>	<i>Part Number</i>	<i>Qty.</i>	<i>Description</i>
1	95-7508	1	Support-Axle
2	95-7506	1	Support-Axle
3	106-1067	1	O-Ring
4	95-7537	2	Bushing-Flanged
5	99-7590	2	Washer-Seal
6	99-7589	2	Plug
7	110-4812	1	Axle Vent ASM
7:3	110-4815	1	Insert-Filter, Foam
8	99-7592	8	Bolt
9	106-1068	2	O-Ring
10	104-2377	1	Extension-Vent
11	104-8643	1	Plug
12	104-8644	1	O-Ring

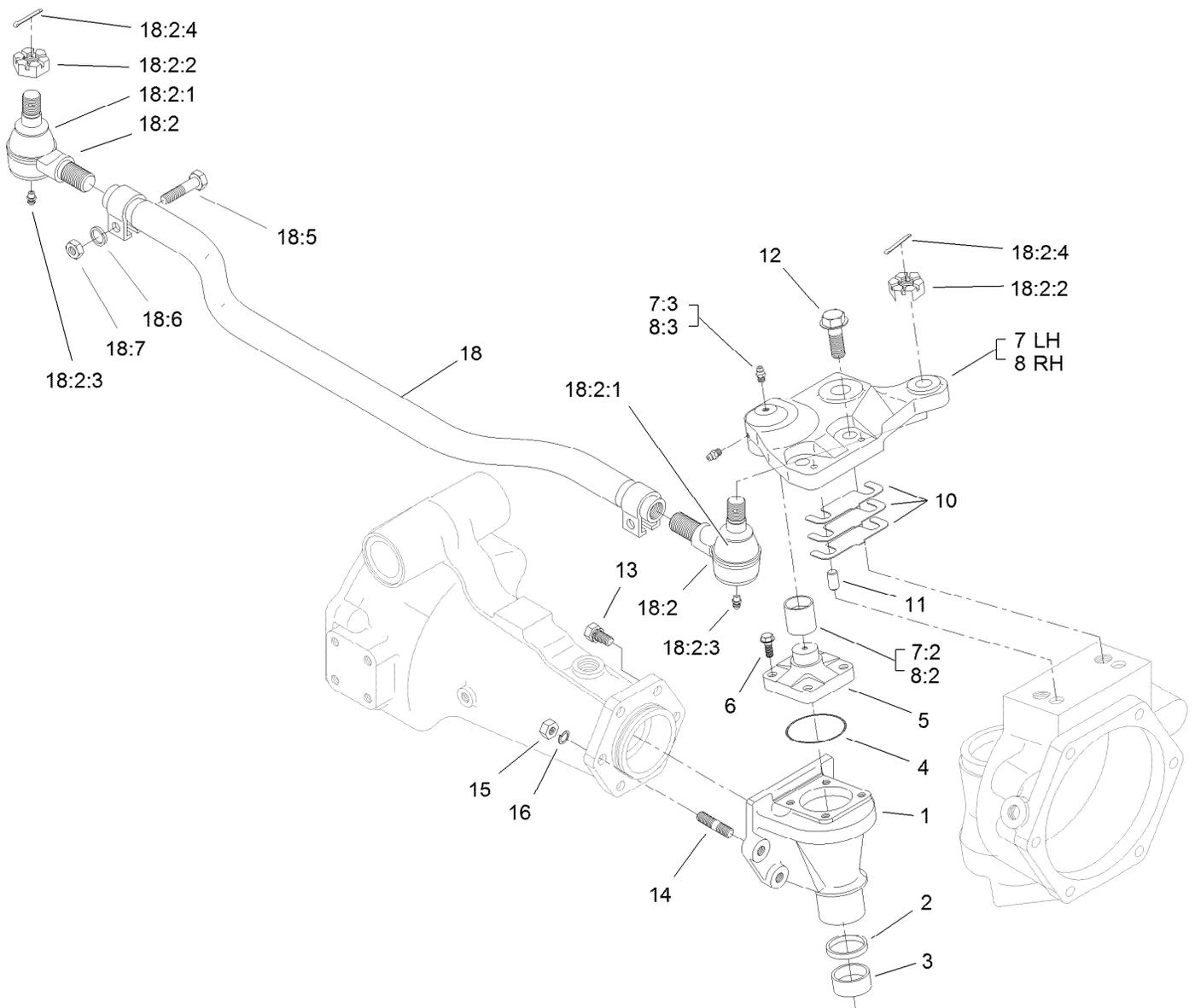

Bevel Gear Case Assembly Rear Axle Assembly No. 110-4750

Ref.	Part Number	Qty.	Description	Ref.	Part Number	Qty.	Description
1	110-4752	2	Case-Gear, Bevel	12	104-2375	4	Bolt
2	110-4754	2	Seal-Oil	13	99-7599	8	Bolt
3	104-2378	2	Bushing	14	99-7525	4	Stud
4	106-1069	2	O-Ring	15	99-7526	4	Nut
5	104-2373	2	Knuckle	16	99-7527	4	Washer-Spring
6	104-2374	8	Bolt	18	106-1141	1	Steering Tie Rod ASM
7	100-3768	1	LH Steering Arm ASM	18:2	106-1113	2	Tie Rod End ASM - RH Thread
7:2	104-8634	1	Bushing	18:2:1	100-3853	1	Cover-Dust
7:3	106-1104	2	Fitting-Grease	18:2:2	100-3854	1	Nut-Castle
8	100-3766	1	RH Steering Arm ASM	18:2:3	110-4755	1	Fitting-Grease
8:2	104-8634	1	Bushing	18:2:4	3272-11	1	Pin-Cotter
8:3	106-1104	2	Fitting-Grease	18:5	100-3855	2	Bolt
10	95-7547	2	Shim 0.1	18:6	99-7527	2	Washer-Spring
10	95-7548	2	Shim 0.2	18:7	99-7526	2	Nut
10	95-7549	2	Shim 0.3				
11	99-7597	4	Pin-Dowel				

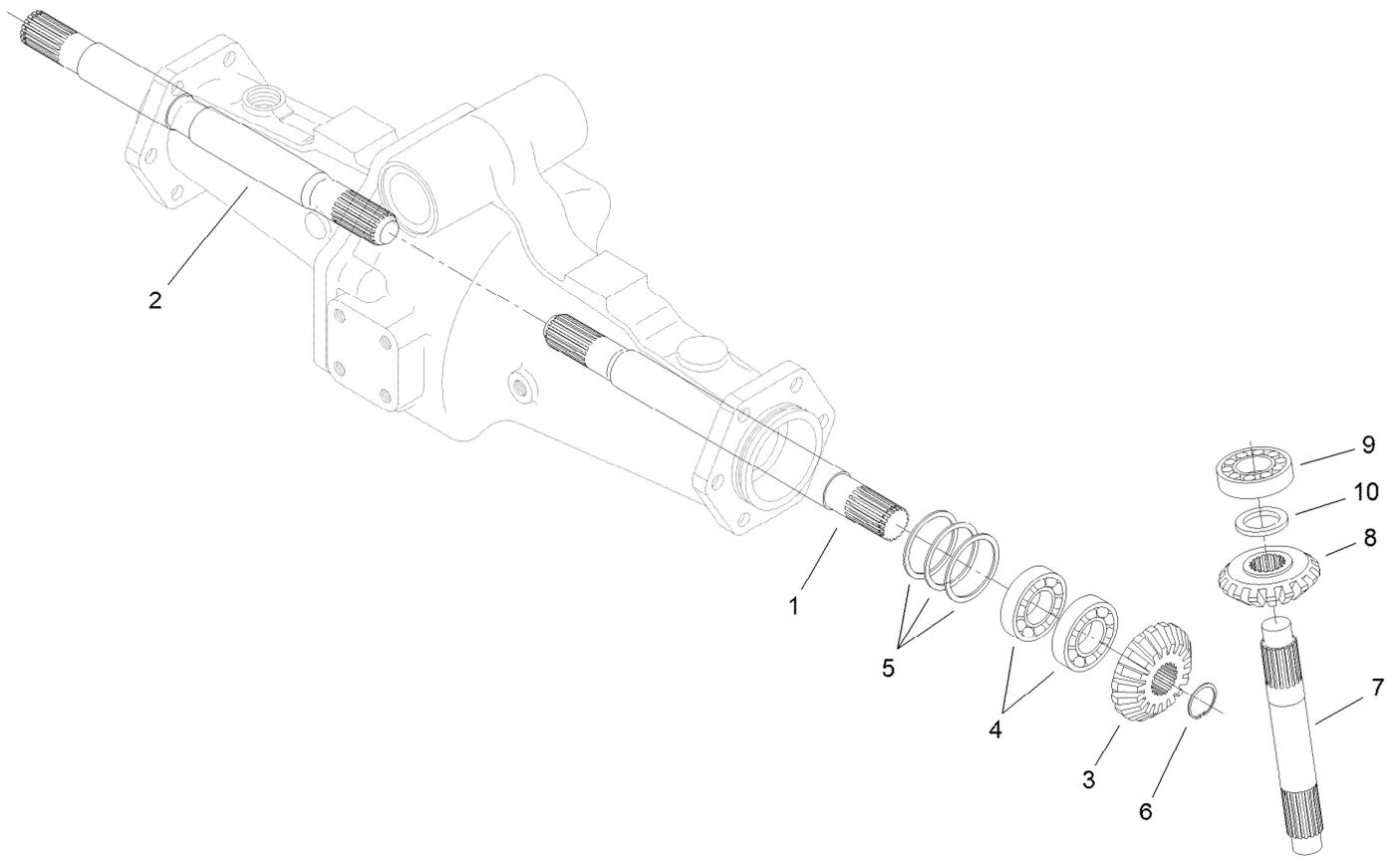

Bevel Gear Shaft Assembly Rear Axle Assembly No. 110-4750

<i>Ref.</i>	<i>Part Number</i>	<i>Qty.</i>	<i>Description</i>
1	95-7509	1	Shaft-Gear, Differential
2	95-7512	1	Shaft-Gear, Differential
3	95-7517	2	Gear-Bevel, 15 Tooth
4	99-7530	4	Bearing-Ball
5	99-7552	2	Shim 0.1
5	99-7553	2	Shim 0.2
5	99-7554	2	Shim 0.5
6	99-7531	2	Clip
7	110-4753	2	Shaft-Gear, Bevel
8	95-7519	2	Gear-Bevel, 17 Tooth
9	99-7532	2	Bearing-Roller, Taper
10	99-7558	2	Collar

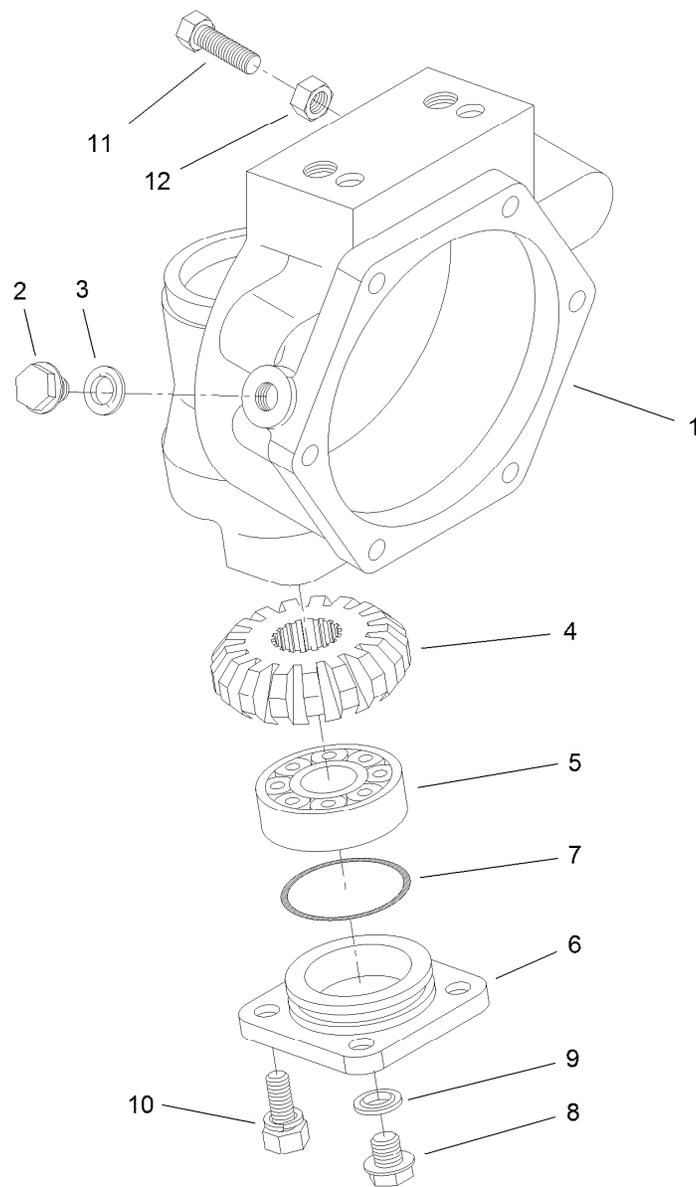

Axle Case Assembly Rear Axle Assembly No. 110-4750

<i>Ref.</i>	<i>Part Number</i>	<i>Qty.</i>	<i>Description</i>
1	110-4751	2	Case-Axle
2	99-7535	2	Plug
3	99-7536	2	Washer-Seal
4	95-7527	2	Gear-Bevel, 17 Tooth
5	99-7532	2	Bearing-Roller, Taper
6	100-2560	2	Cover
7	106-1070	2	O-Ring
8	99-7589	2	Plug
9	99-7590	2	Washer-Seal
10	100-2562	8	Bolt
11	106-1102	2	Bolt-Stop
12	106-1103	2	Nut

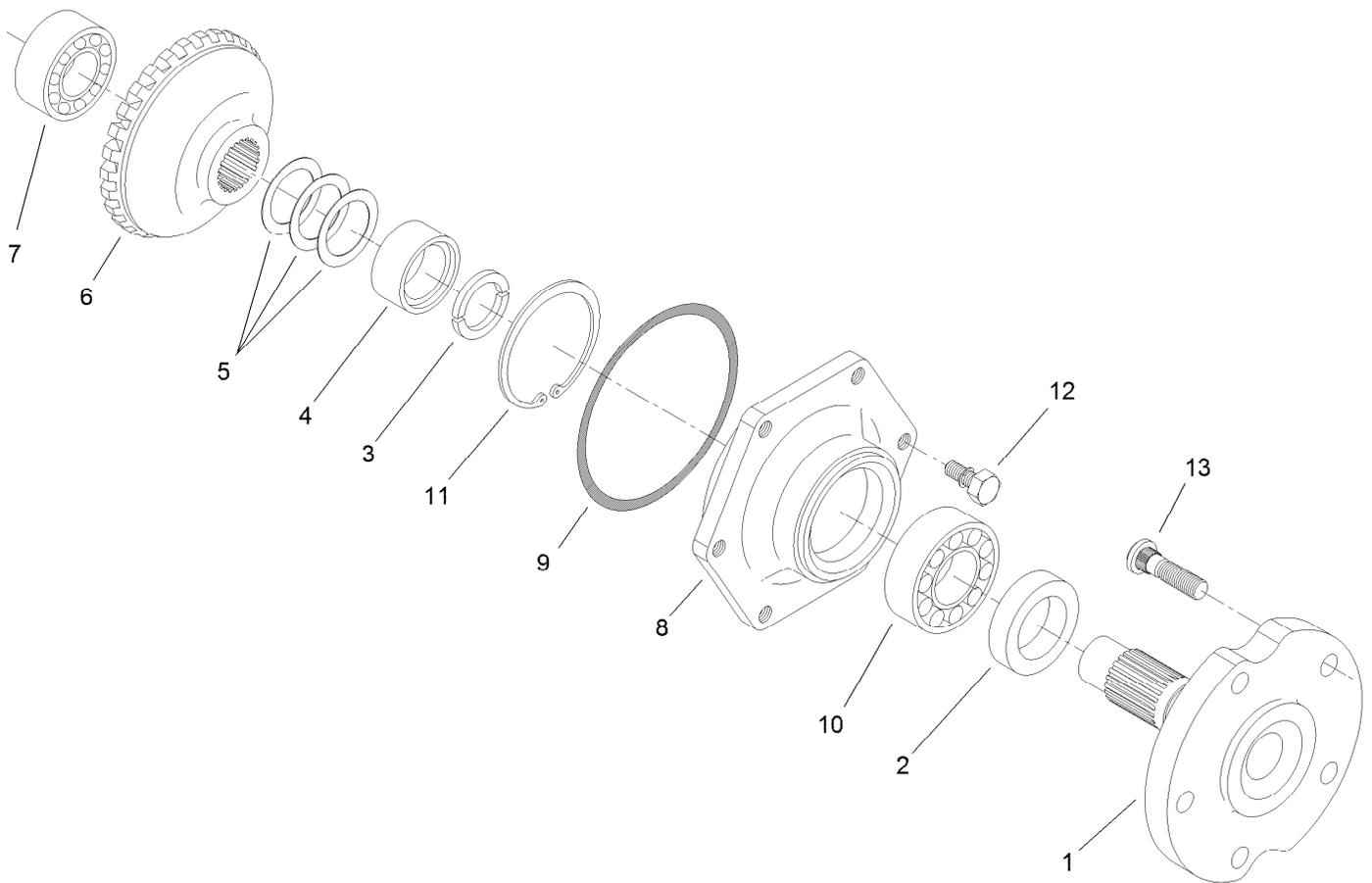

Axle Assembly Rear Axle Assembly No. 110-4750

<i>Ref.</i>	<i>Part Number</i>	<i>Qty.</i>	<i>Description</i>
1	95-7522	2	Axle
2	99-7564	2	Seal-Oil
3	95-7544	4	Clip
4	95-7523	2	Spacer
5	99-7555	2	Shim 0.3
5	99-7556	2	Shim 0.2
5	99-7557	2	Shim 0.5
6	95-7524	2	Gear-Bevel, 29 Tooth
7	99-7534	2	Bearing-Ball
8	95-7521	2	Cover-Axle
9	106-1071	2	O-Ring
10	99-7561	2	Bearing-Ball
11	99-7539	2	Clip
12	99-7596	12	Bolt
13	99-7563	10	Stud

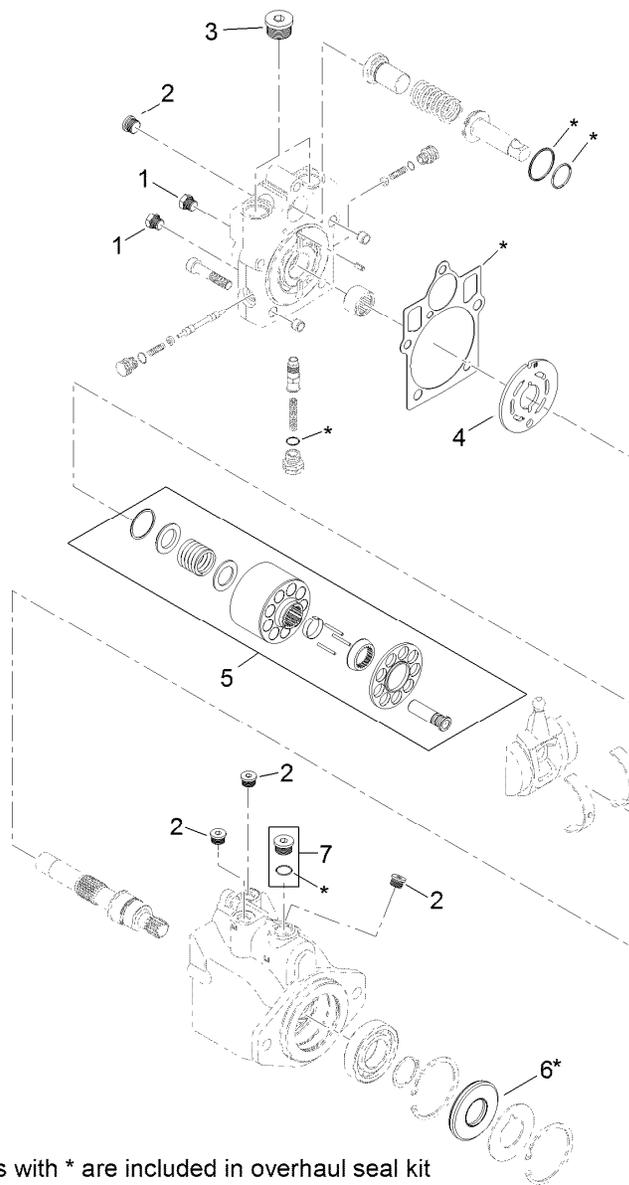

8 = all items with * are included in overhaul seal kit

Hydraulic Motor Assembly No. 120-8814

<i>Ref.</i>	<i>Part Number</i>	<i>Qty.</i>	<i>Description</i>
1	92-1352	2	Plug
2	69-3080	5	Plug
3	69-3130	2	Plug
4	121-1734	1	Plate-Valve
5	110-6472	1	Cylinder Block Kit ASM
6	69-3190	1	Seal-Lip
7	67-9090	1	Plug
8	121-1736	1	Overhaul Seal Kit

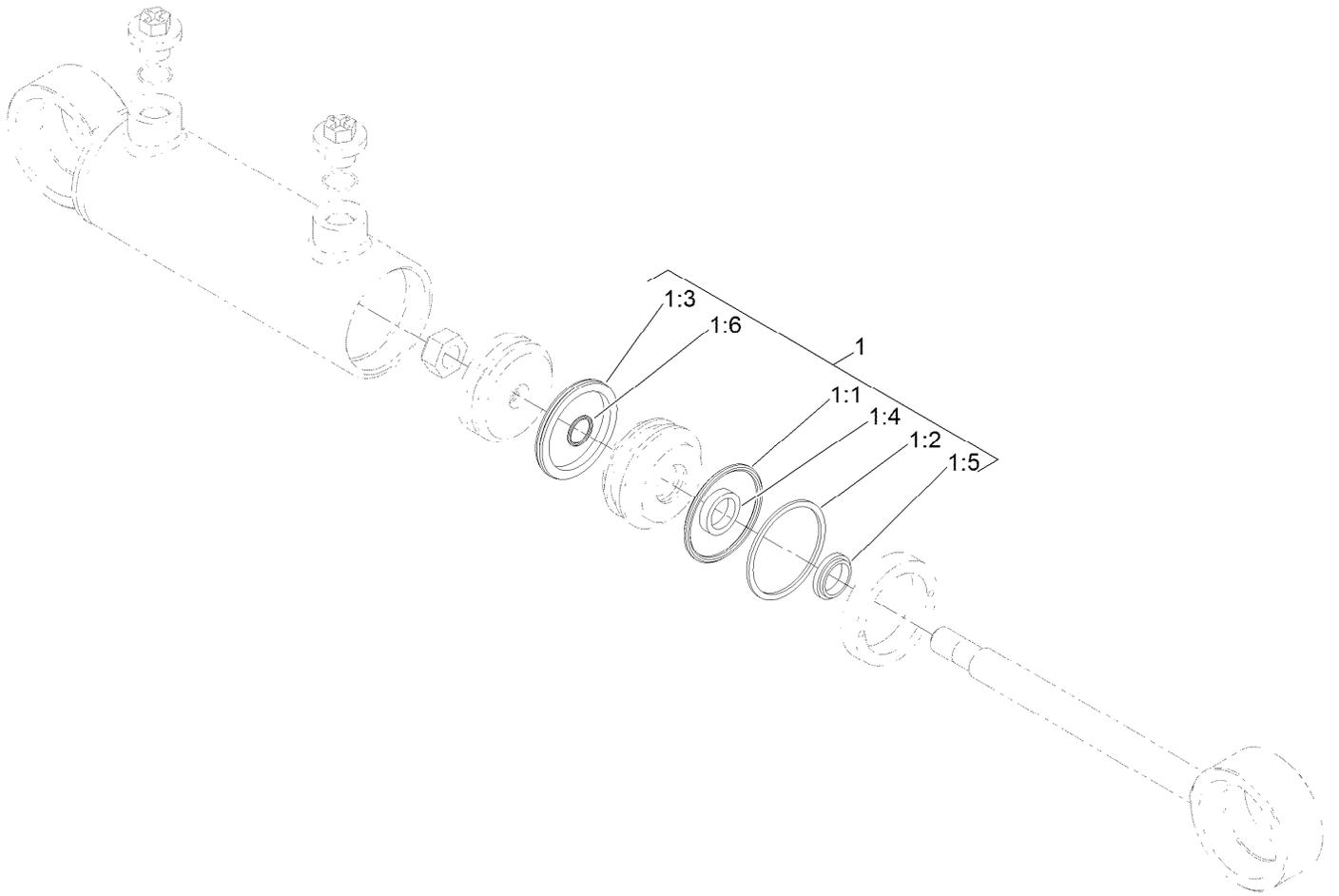

Steering Cylinder Assembly No. 121-1534

<i>Ref.</i>	<i>Part Number</i>	<i>Qty.</i>	<i>Description</i>
1	125-4302	1	Seal Kit
1:1		1	O-Ring ●
1:2		1	Backup ●
1:3		1	Bp Seal ●
1:4		1	Bt Seal ●
1:5		1	Dust Seal ●
1:6		1	O-Ring ●

● Not serviced separately

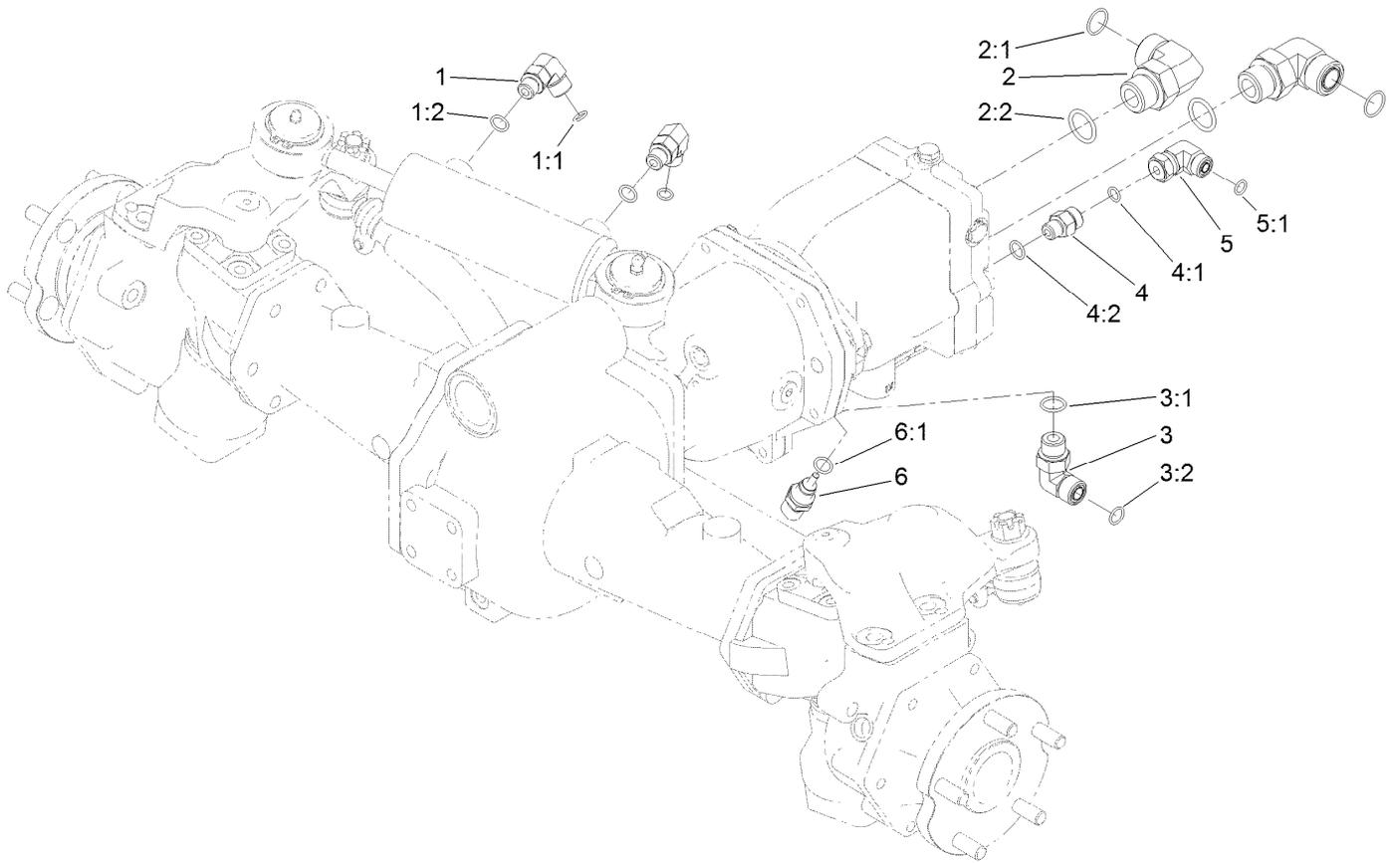

Hydraulic Fitting Assembly

<i>Ref.</i>	<i>Part Number</i>	<i>Qty.</i>	<i>Description</i>	<i>Ref.</i>	<i>Part Number</i>	<i>Qty.</i>	<i>Description</i>
1	340-77	2	Fitting-Elbow, 90 DEG	3:2	237-30	1	O-Ring
1:1	237-22	1	O-Ring	4	340-2	1	Fitting-Straight
1:2	237-42	1	O-Ring	4:1	237-22	1	O-Ring
2	340-142	2	Fitting-Elbow, 90 DEG	4:2	237-42	1	O-Ring
2:1	237-58	1	O-Ring	5	340-159	1	Elbow-90
2:2	237-81	1	O-Ring	5:1	237-22	2	O-Ring
3	340-98	1	Fitting-Elbow, 90 DEG	6	110-8829	1	Sender-Temperature
3:1	237-79	1	O-Ring	6:1	237-42	1	O-Ring

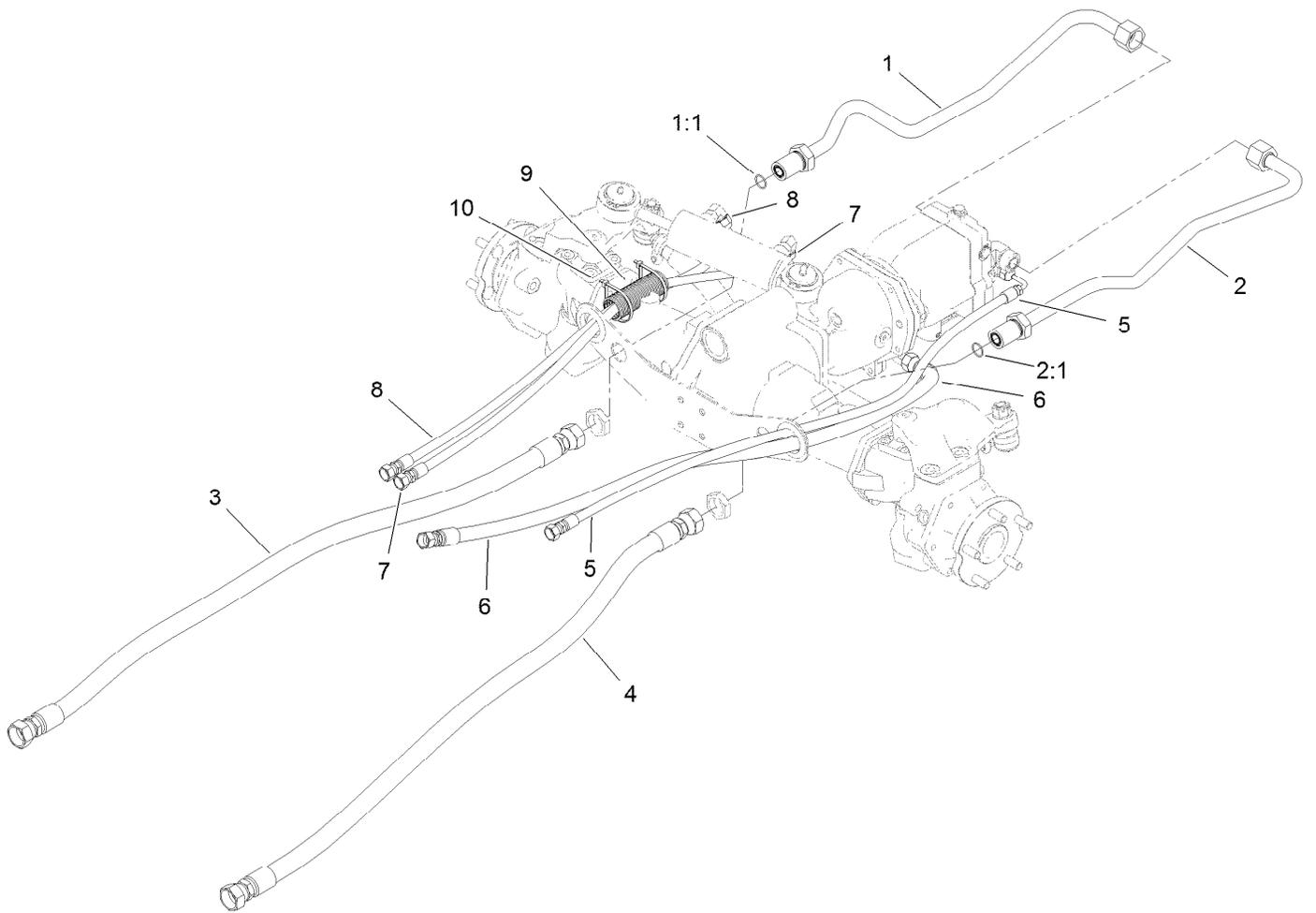

Hose and Tube Routing Assembly

<i>Ref.</i>	<i>Part Number</i>	<i>Qty.</i>	<i>Description</i>
1	120-9067	1	HYD Tube ASM
1:1	237-58	1	O-Ring
2	120-9068	1	Tube ASM
2:1	237-58	1	O-Ring
3	121-1502	1	Hose-HYD
4	114-0024	1	Hose-HYD
5	121-1459	1	Hose-HYD
6	121-1458	1	Hose-HYD
7	121-1500	1	Hose-HYD
8	121-1501	1	Hose-HYD
9	121-1544	2	Cover-Hose
10	3290-379	4	Tie-Cable

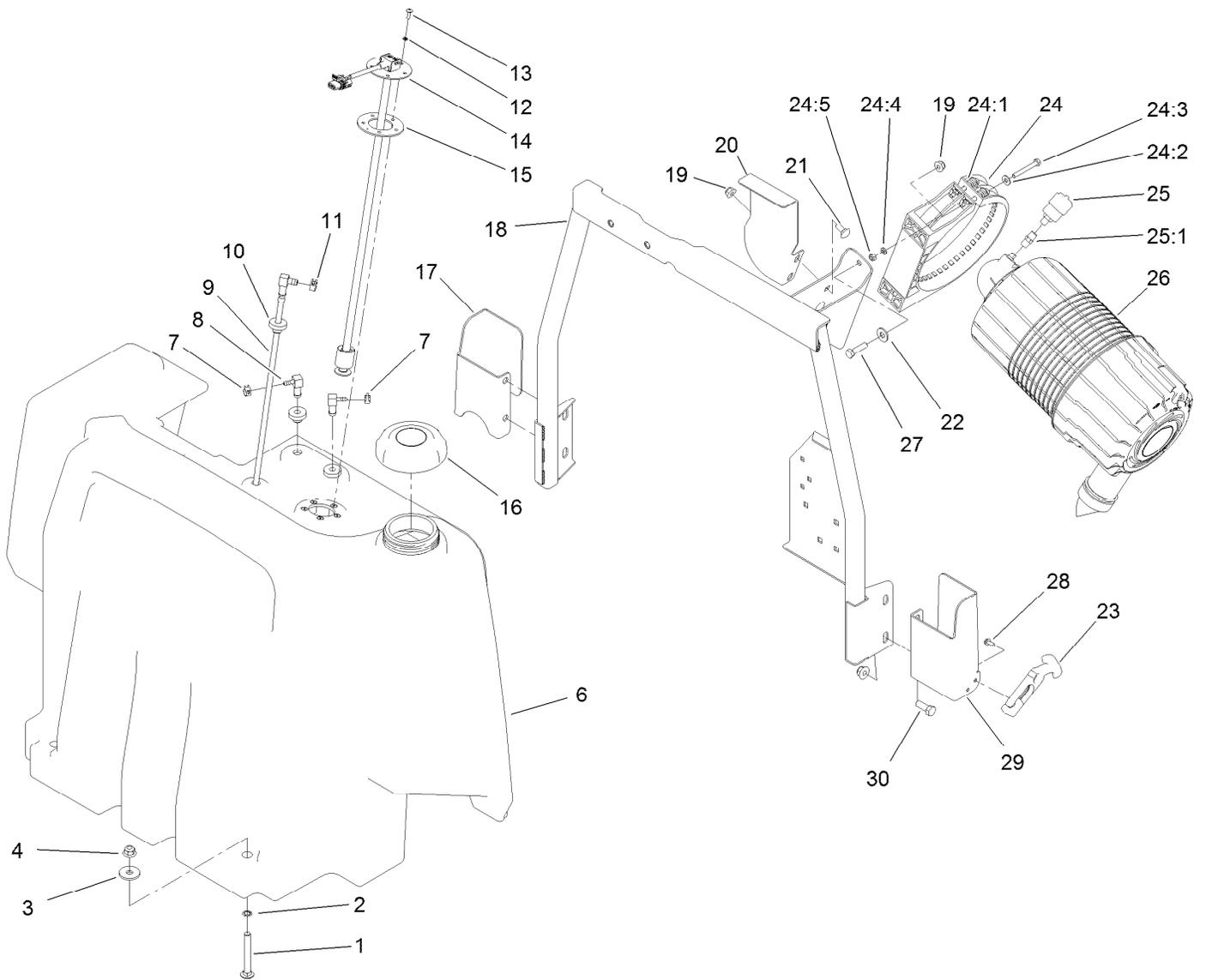

Fuel Tank and Air Cleaner Assembly

Ref.	Part Number	Qty.	Description	Ref.	Part Number	Qty.	Description
1	3231-10	2	Screw-CARR	20	120-4193-03	1	Bracket-Fuel Tank
2	32151-72	2	Ring-Retaining	21	3230-1	2	Bolt-CARR
3	63-8410	2	Washer	22	3256-3	2	Washer-Flat
4	104-8301	6	Nut-HF, NI	23	103-4080	2	Latch-Rubber
6	120-4195	1	Tank-Fuel	24	99-5414	1	Strap-Cleaner, Air
7	2412-98	2	Clamp-Hose	24:1	108-1512	2	Spring
8	104-5228	2	Fitting-Elbow, 90 DEG	24:2	3256-22	2	Washer-Flat
9	120-8908	1	Pipe-Stand	24:3	33113-050	2	Screw-HH
10	46-6560	3	Bushing	24:4	33093-00	2	Washer-Flat
11	92-2379	1	Clamp-Hose	24:5	33023-00	2	Nut-Lock
12	3253-15	5	Washer-Lock	25	104-3563	1	Indicator
13	32122-24	5	Screw-PTH	25:1	94-1416	1	Adapter-Indicator
14	121-1688	1	Gauge-Fuel	26	99-5410	1	Air Cleaner ASM
15	121-1707	1	Gasket-Fuel, Viton	27	322-6	2	Screw-HH
16	119-8266	1	Cap-Fuel (Biodiesel)	28	32144-1	4	Screw-Taptite
17	121-1514-03	1	Bracket-Latch, RH	29	121-1513-03	1	Bracket-Latch, LH
18	120-4190-03	1	Support-Tank	30	323-6	4	Screw-HH
19	104-8300	4	Nut-HF, NI				

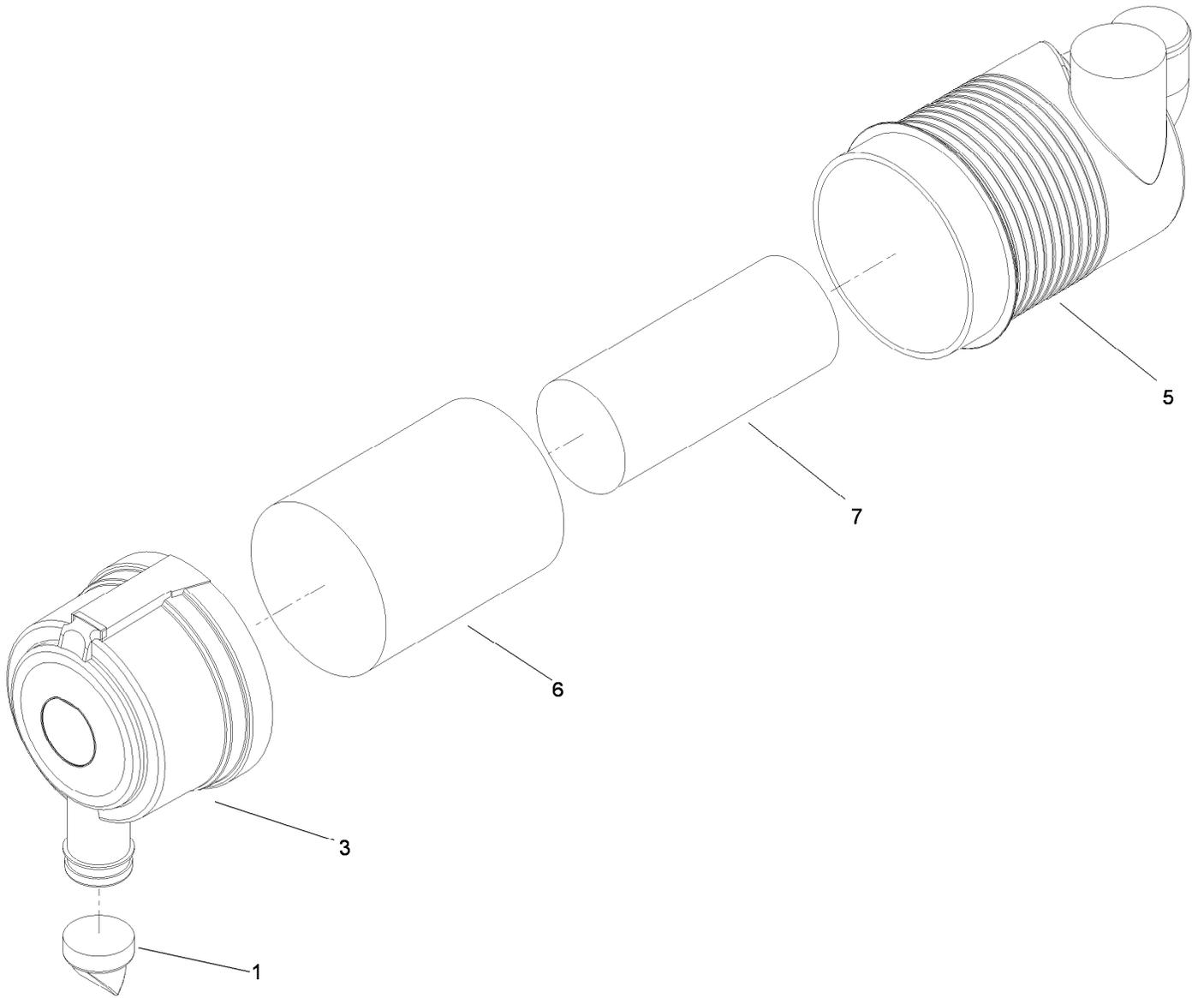

Air Cleaner Assembly No. 99-5410

<i>Ref.</i>	<i>Part Number</i>	<i>Qty.</i>	<i>Description</i>
1	104-4258	1	Valve-Vacuator
3	104-4259	1	Cover
5		1	Body ASM ●
6	108-3814	1	Filter-Air
7	108-3816	1	Filter-Air

● Not serviced separately

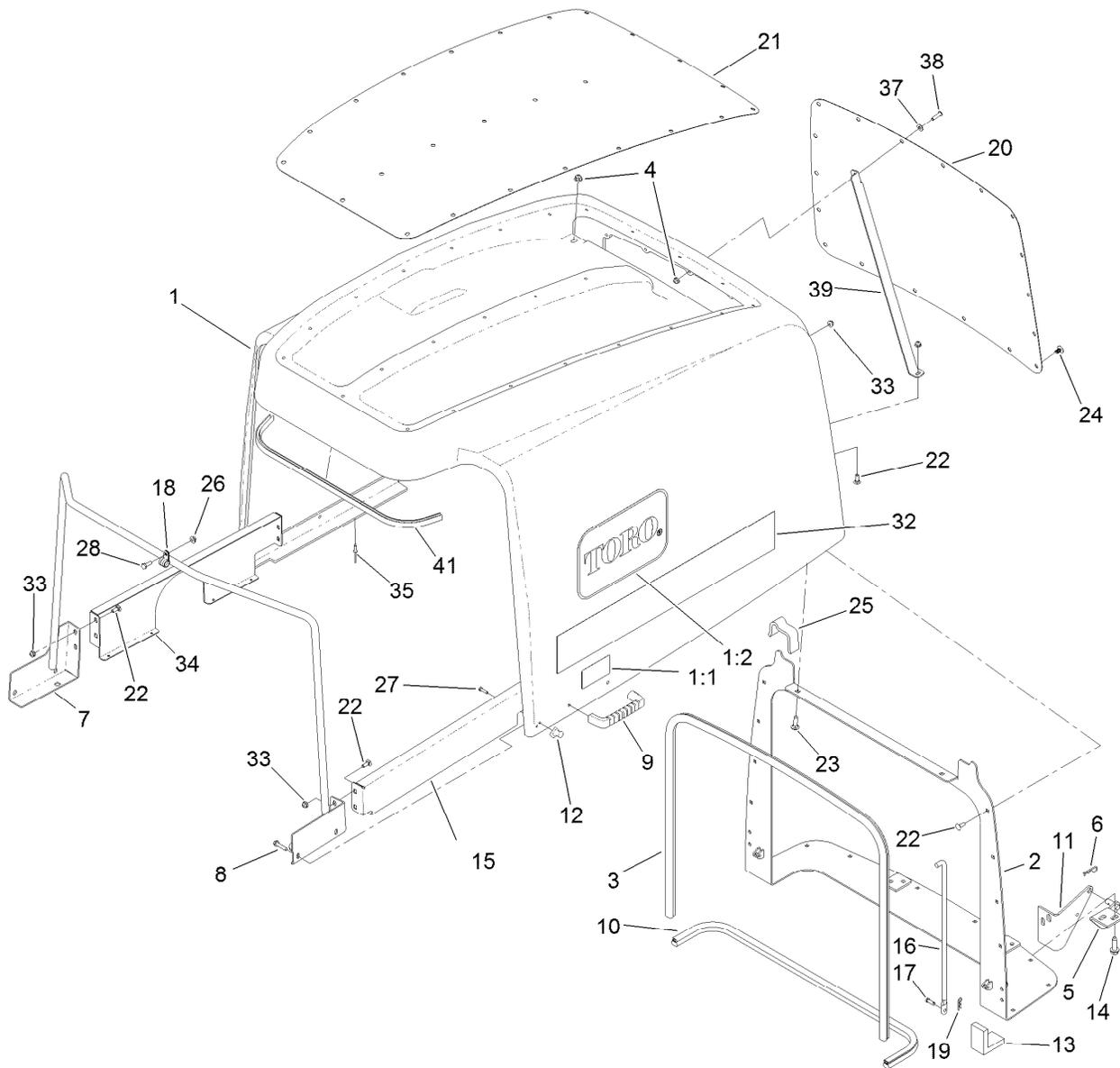

Hood Assembly

Ref.	Part Number	Qty.	Description	Ref.	Part Number	Qty.	Description
1	120-9090	1	Hood ASM	18	2412-134	2	Clamp-R
1:1	106-6754	2	Decal-Danger	19	3290-307	2	Pin-Cotter
1:2	66-1210	2	Decal	20	120-9096-03	1	Screen-Hood, Rear
2	120-9099-03	1	Pivot-Hood	21	120-9097-03	1	Screen-Hood, Top
3	114-3823	1	Seal-Bulb	22	3229-1	24	Screw-CARR
4	104-8300	2	Nut-HF, NI	23	3230-2	2	Bolt-CARR
5	121-1470	2	Pivot-Screen	24	117-2382	42	Plug-Plastic
6	3290-467	2	Pin-Hair	25	120-9087	2	Seal-Foam
7	120-4196-03	1	Support-Hood	26	32128-33	2	Nut-HF
8	46-8092	4	Screw-Plastite	27	32104-4	2	Screw
9	65-5100	2	Handle-Door	28	321-4	2	Screw-HH
10	104-3590	1	Seal-Bulb	32	119-0054	2	Decal-Hood
11	104-3588-03	2	Pivot-Screen	33	104-7201	25	Nut-HF, NI
12	103-4081	2	Latch-Keeper	34	120-8948-03	1	Support-Hood, RH
13	104-3580	2	Seal-Corner, Screen	35	3269-4	8	Rivet-Pop
14	32144-109	8	Screw-Thd	37	3256-1	1	Washer-Flat
15	120-8949-03	1	Support-Hood, LH	38	3274-65	1	Screw-HSBH
16	104-8313	2	Rod-Hood	39	127-3707-03	1	Support-Hood
17	283-67	2	Pin-Clevis	41	132-6181	1	Trim

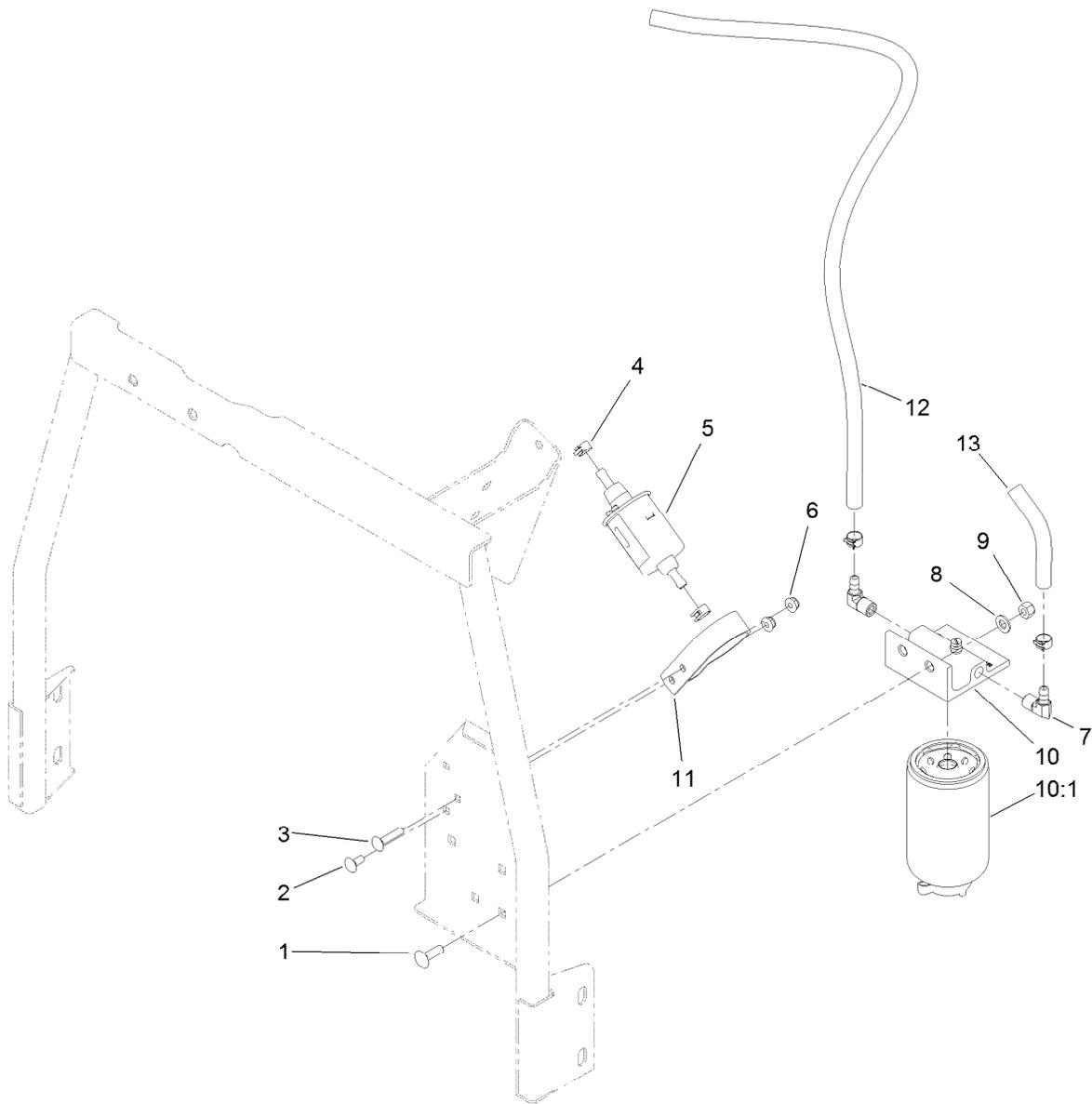

Fuel/Water Separator Assembly

Ref.	Part Number	Qty.	Description
1	3230-22	2	Screw-CARR
2	3229-11	1	Screw-CARR
3	3229-3	1	Screw-CARR
4	92-2379	4	Clamp-Hose
5	110-8806	1	Pump-Fuel
6	104-7201	2	Nut-HF, NI
7	353-781	2	Fitting-HYD, 90
8	3256-23	2	Washer-Plain
9	3296-29	2	Nut-Lock, NI
10	110-9044	1	Separator-Filter
10:1	110-9049	1	Filter-Spin On, Fuel/Water
11	110-8817	1	Bracket-Pump, Fuel
12	110-6186	1	Hose-Fuel
13	110-3256	1	Hose-Fuel

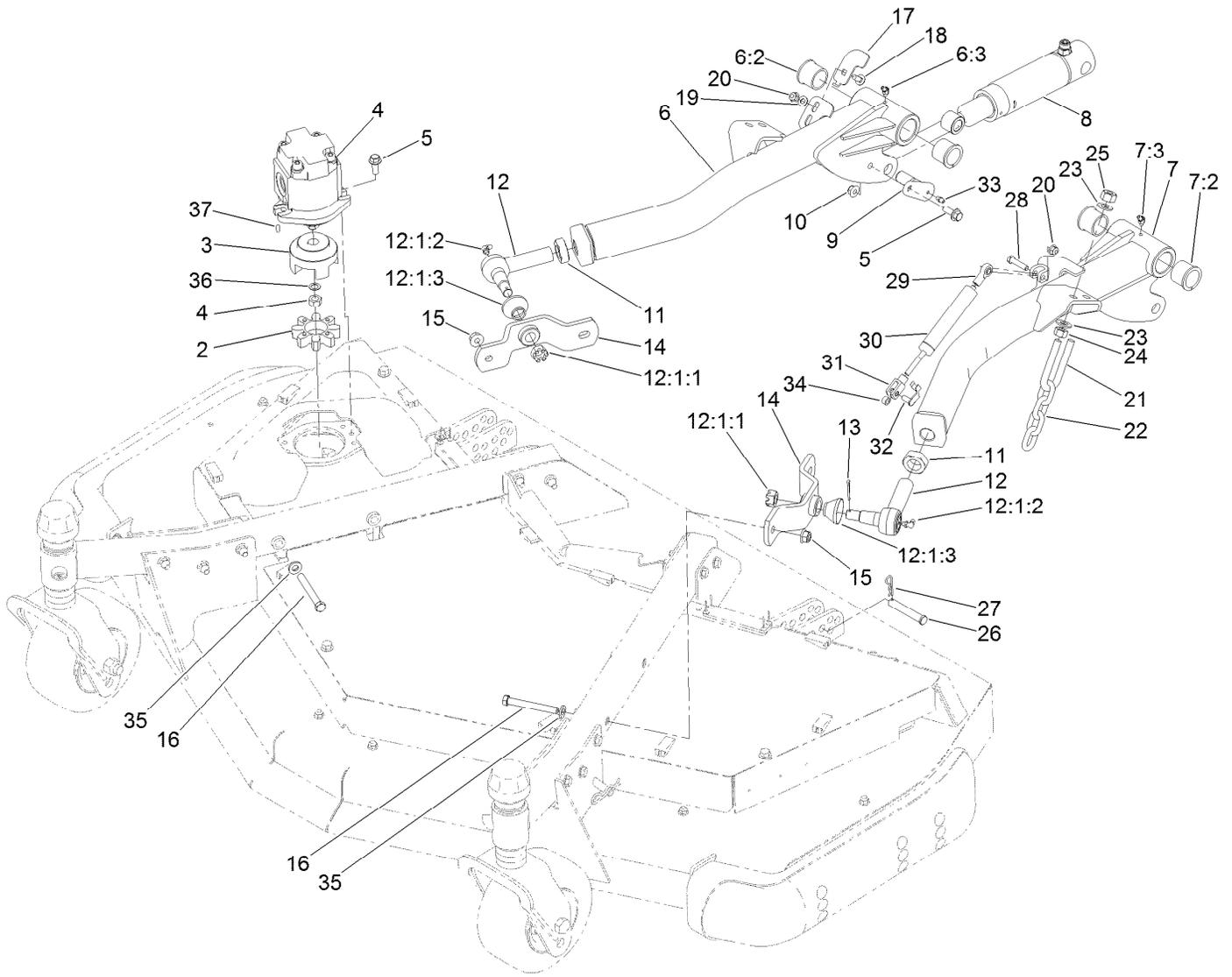

Front Deck Installation Assembly

Ref.	Part Number	Qty.	Description	Ref.	Part Number	Qty.	Description
2	104-3542	1	Spider	16	324-19	4	Screw-HH
3	104-3541	1	Hub-Spider	17	120-8893	1	Plate-Sensor
4	127-3694	1	HYD Motor ASM	18	3230-23	1	Bolt-CARR
5	3234-42	4	Screw-HHF	19	3256-23	1	Washer-Plain
6	120-8878	1	RH Lift Arm ASM	20	104-8300	2	Nut-HF, NI
6:2	104-0015	2	Bushing-Flange	21	104-0108	2	U-Bolt
6:3	302-11	1	Fitting-Lube, 45 DEG	22	95-6231	2	Chain-HOC
7	120-8879	1	LH Lift Arm ASM	23	3256-26	8	Washer-Flat
7:2	104-0015	2	Bushing-Flange	24	3217-9	4	Nut-HH
7:3	302-11	1	Fitting-Lube, 45 DEG	25	3296-25	4	Nut-Lock, NI
8	120-8802	2	HYD Cylinder ASM	26	283-55	2	Pin-Clevis
9	120-5575	2	Pin	27	3290-467	2	Pin-Hair
10	104-8301	2	Nut-HF, NI	28	322-17	1	Screw-HH
11	21-3001	2	Nut-Jam	29	104-8331	1	End-Rod, Spherical
12	86-8101-01	2	Joint-Ball, LH	30	105-3249	1	Damper
12:1:1	32136-2	1	Nut-SHH	31	115-5455	1	End-Rod, Clevis
12:1:2	302-40	1	Fitting-Grease, 90 DEG	32	115-5454	1	Pin-Spring
12:1:3	114-2874	1	Seal-Ball Joint	33	302-5	2	Fitting-Grease
13	3272-12	2	Pin-Cotter	34	115-2142	1	Spacer
14	93-4583-01	2	Mount-Joint, Ball	35	87-7480	4	Washer
15	114-8417	4	Nut-HF, NI				

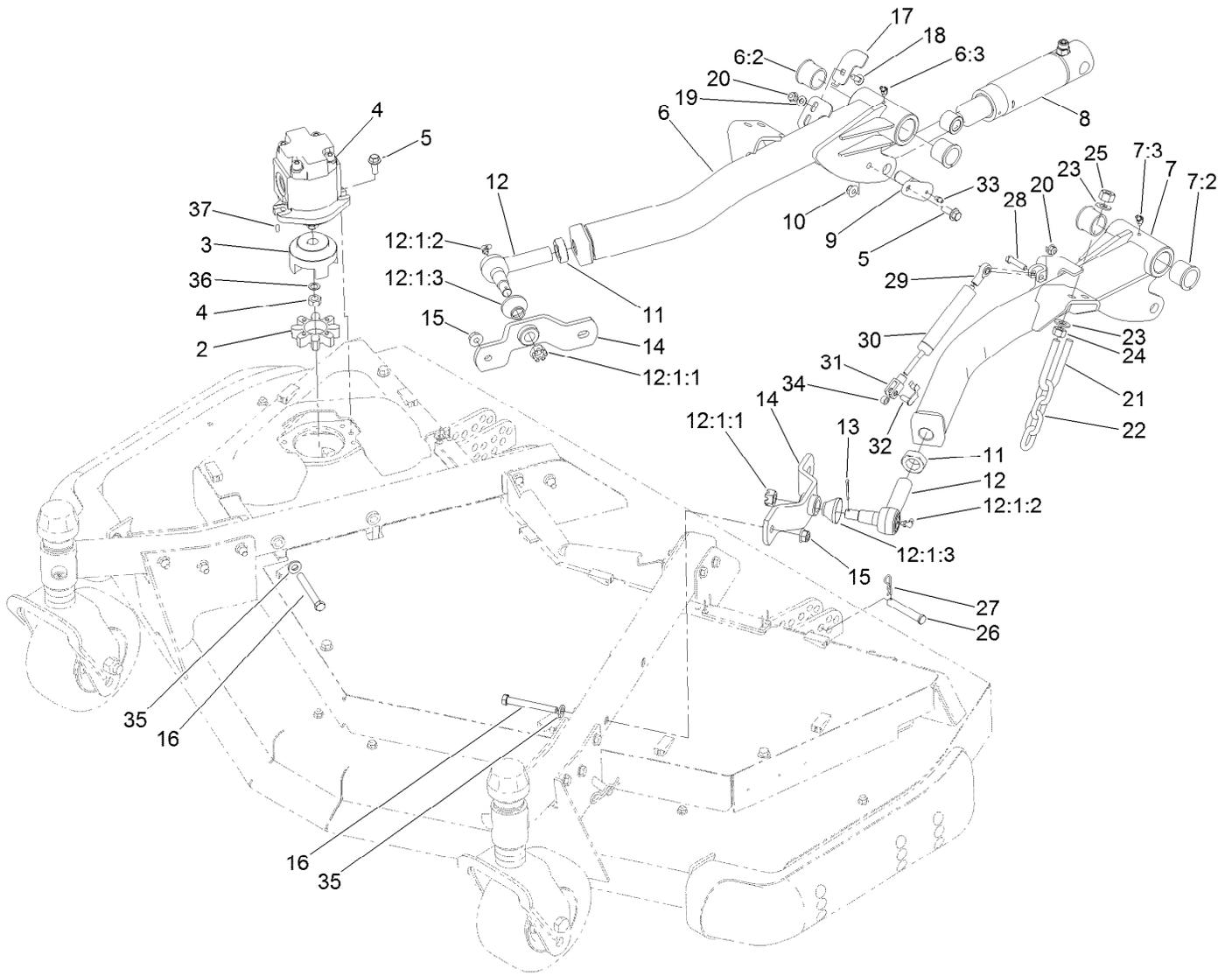

Front Deck Installation Assembly (continued)

<i>Ref.</i>	<i>Part Number</i>	<i>Qty.</i>	<i>Description</i>
36	112-6957	1	Washer-Hardened
37	3257-3	1	Key-Woodruff

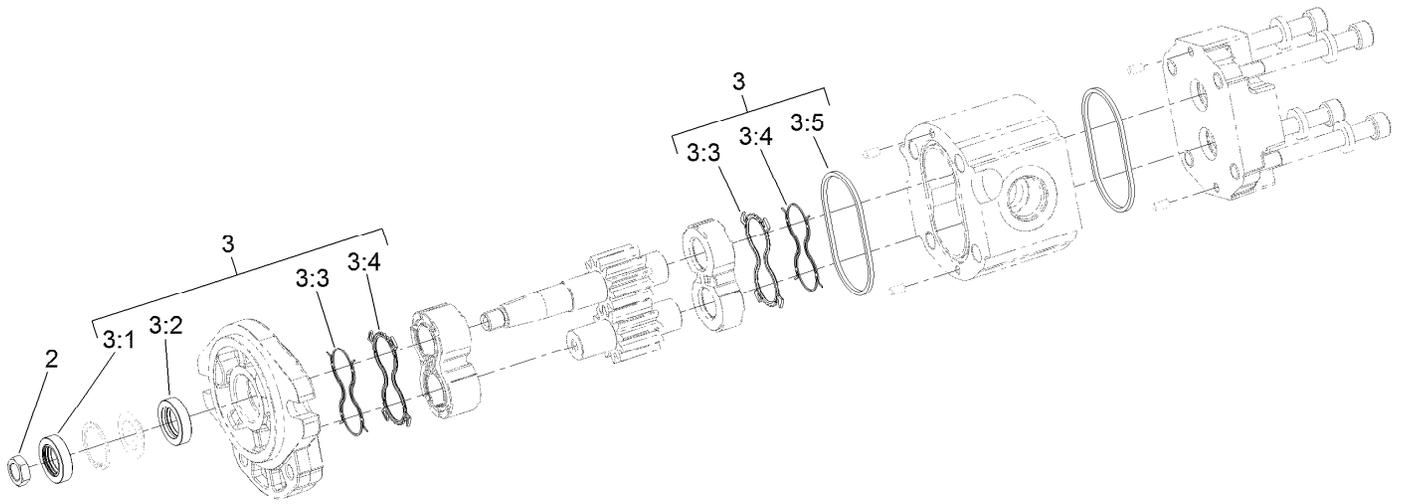

Hydraulic Motor Assembly No. 127-3694

Ref.	Part Number	Qty.	Description
2	110-8815	1	Nut-Hex
3	114-5620	1	Seal Kit
3:1		1	Seal-Shaft ●
3:2		1	Seal-Shaft ●
3:3		2	Seal-Anti Extrusion ●
3:4		2	Seal-Plate, Balancing ●
3:5		2	O Ring-Housing ●

● Not serviced separately

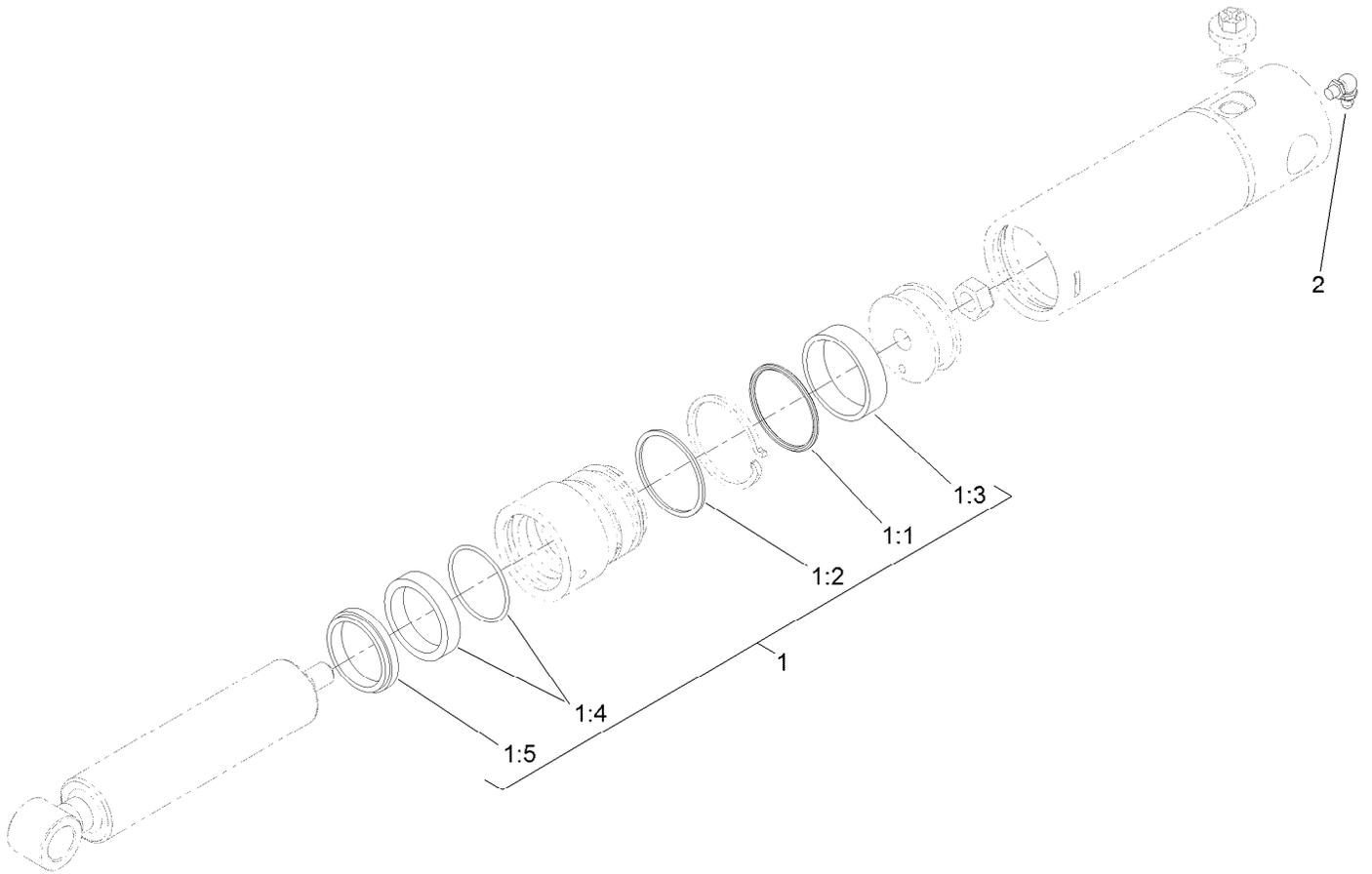

Lift Cylinder Assembly No. 120-8802

<i>Ref.</i>	<i>Part Number</i>	<i>Qty.</i>	<i>Description</i>
1	125-4301	1	Seal Kit
1:1		1	O-Ring ●
1:2		1	Backup ●
1:3		1	Wear Ring ●
1:4		1	Bds Seal ●
1:5		1	Dust Seal ●
2	302-60	1	Fitting-Grease

● Not serviced separately

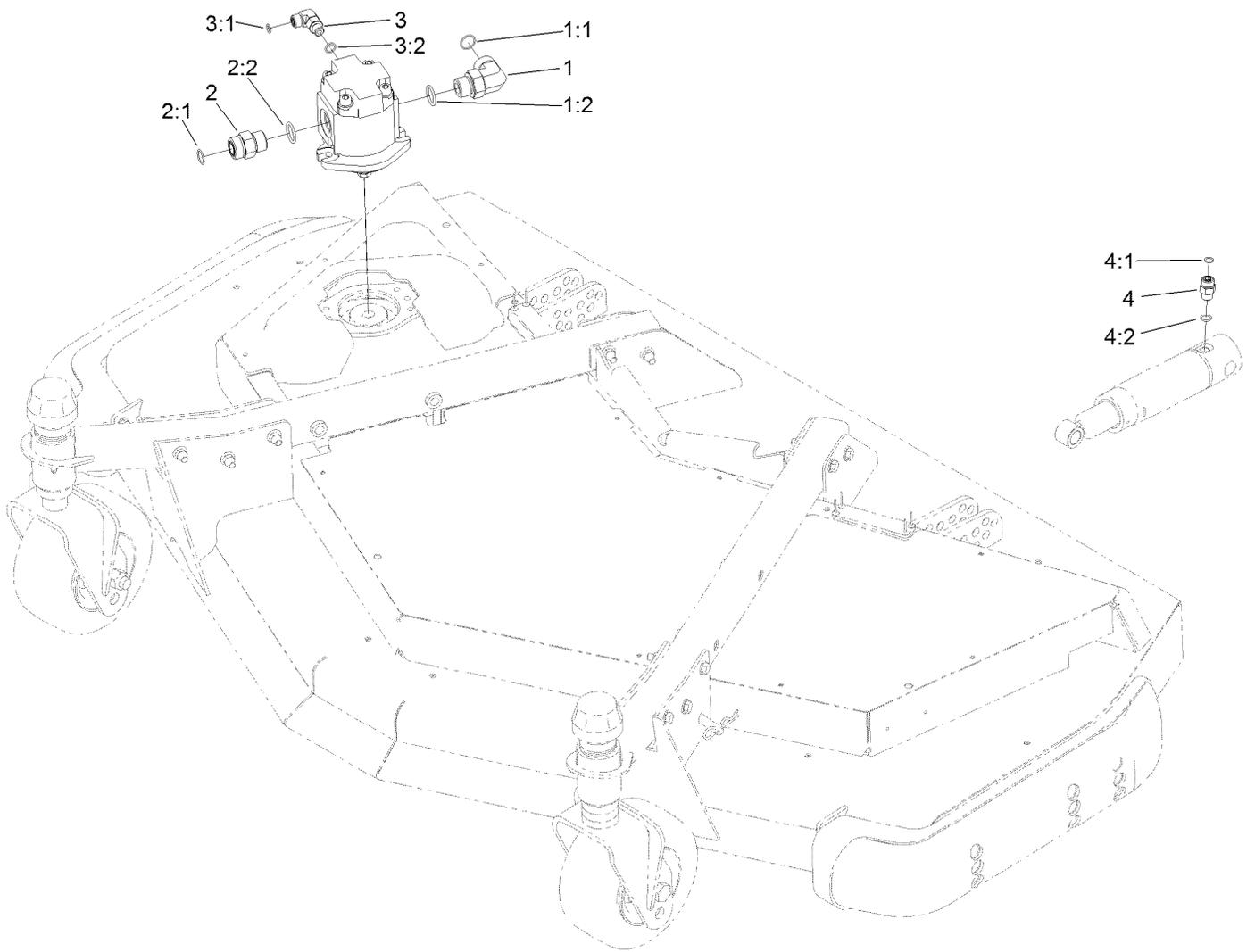

Front Deck Hydraulic Fitting Assembly

Ref.	Part Number	Qty.	Description
1	340-142	1	Fitting-Elbow, 90 DEG
1:1	237-58	1	O-Ring
1:2	237-81	1	O-Ring
2	340-9	1	Fitting-STR
2:1	237-58	1	O-Ring
2:2	237-81	1	O-Ring
3	340-77	1	Fitting-Elbow, 90 DEG
3:1	237-22	1	O-Ring
3:2	237-42	1	O-Ring
4	340-2	2	Fitting-Straight
4:1	237-22	1	O-Ring
4:2	237-42	1	O-Ring

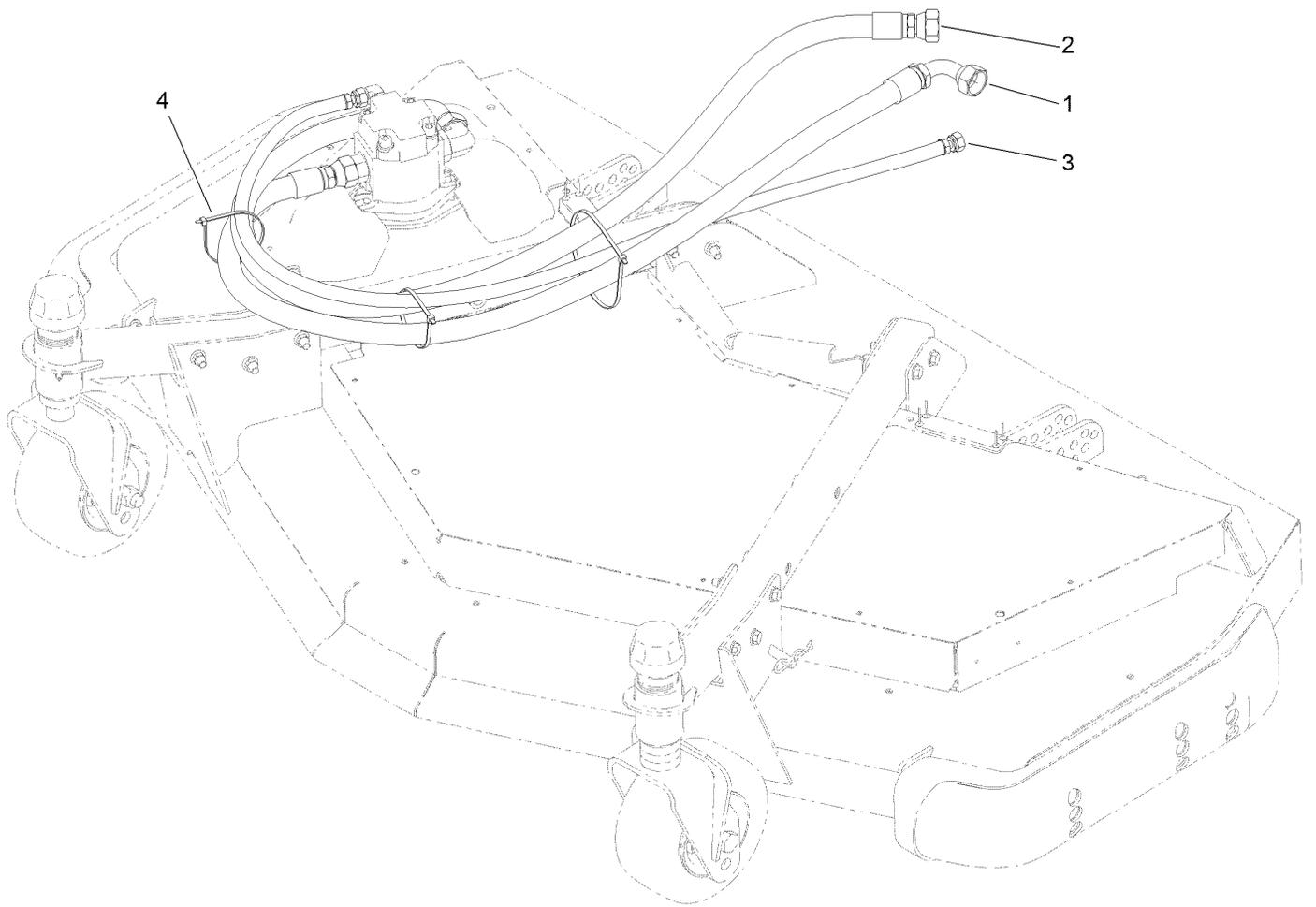

Front Deck Hose Routing Assembly

<i>Ref.</i>	<i>Part Number</i>	<i>Qty.</i>	<i>Description</i>
1	120-8987	1	Hose-HYD
2	120-8988	1	Hose-HYD
3	120-8989	1	Hose-HYD
4	3290-379	3	Tie-Cable

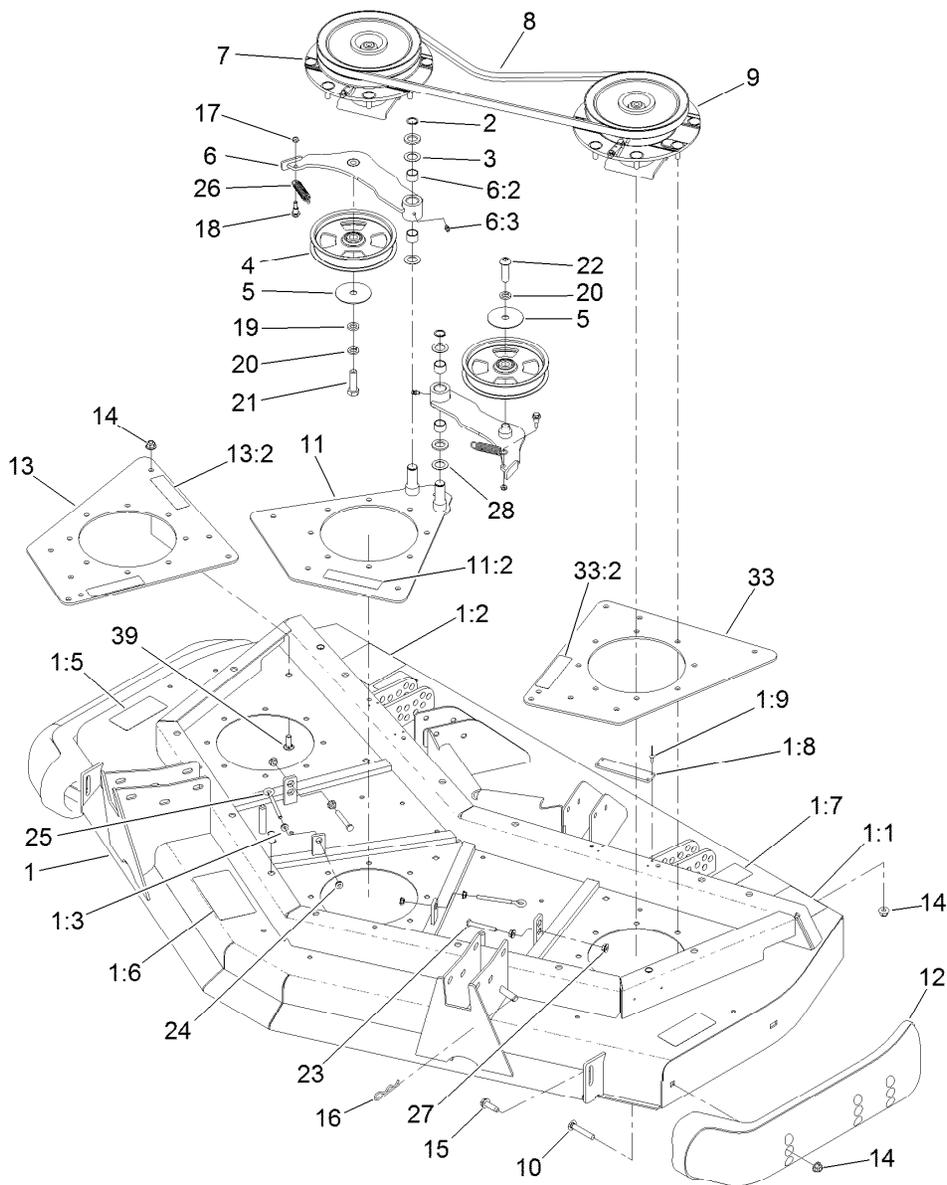

Front Deck Idler and Skid Assembly

Ref.	Part Number	Qty.	Description	Ref.	Part Number	Qty.	Description
1	131-1234	1	Front Deck ASM	11:2	100-6578	1	Decal-Danger
1:1	120-6604	2	Decal-Danger	12	112-1479	2	Skid-Bumper, Deck
1:2	100-5624	1	Decal-HOC, RH	13	131-1238	1	Plate-Spindle, Front Right
1:3	32148-9	3	Nut-Clinch	13:2	100-6578	2	Decal-Danger
1:5	93-7818	2	Decal-Torque, Blade Bolt	14	104-8301	36	Nut-HF, NI
1:6	100-5622	1	Decal-HOC	15	9136144	2	Screw-HWHTF
1:7	104-3578	1	Decal-HOC, LH	16	3290-355	1	Pin-Hair
1:8	105-0786	2	Pad-Plastic	17	3296-56	2	Nut-Lock, NI
1:9	3269-8	8	Rivet-Blind	18	104-0858	2	Bolt-Shoulder
2	32120-72	2	Ring-Snap	19	9202424	1	Spacer
3	3-6498	4	Washer-Thrust	20	3253-7	2	Washer-Lock
4	132-9421	2	Pulley-Idler, Flat	21	325-7	1	Screw-HH
5	100-3102	2	Washer-Flat	22	108-1993	1	Screw-HSBH
6	110-6128	2	Idler Arm ASM	23	9114524	2	Bolt-TAP, HH
6:2	256-76	2	Bushing	24	32128-14	4	Nut-HF
6:3	302-5	1	Fitting-Grease	25	68-0090	4	Screw-Adjusting
7	119-4548	1	Double Driven Spindle ASM	26	107938	2	Spring-Extension
8	108-8076	2	V-Belt, Deck	27	32128-26	4	Nut-HF
9	119-4549	1	High-Driven Spindle ASM	28	70-1160	2	Washer
10	3231-33	4	Screw-CARR	33	131-1239	1	Plate-Spindle, Front Left
11	131-1237	1	Plate-Spindle, Front Center				

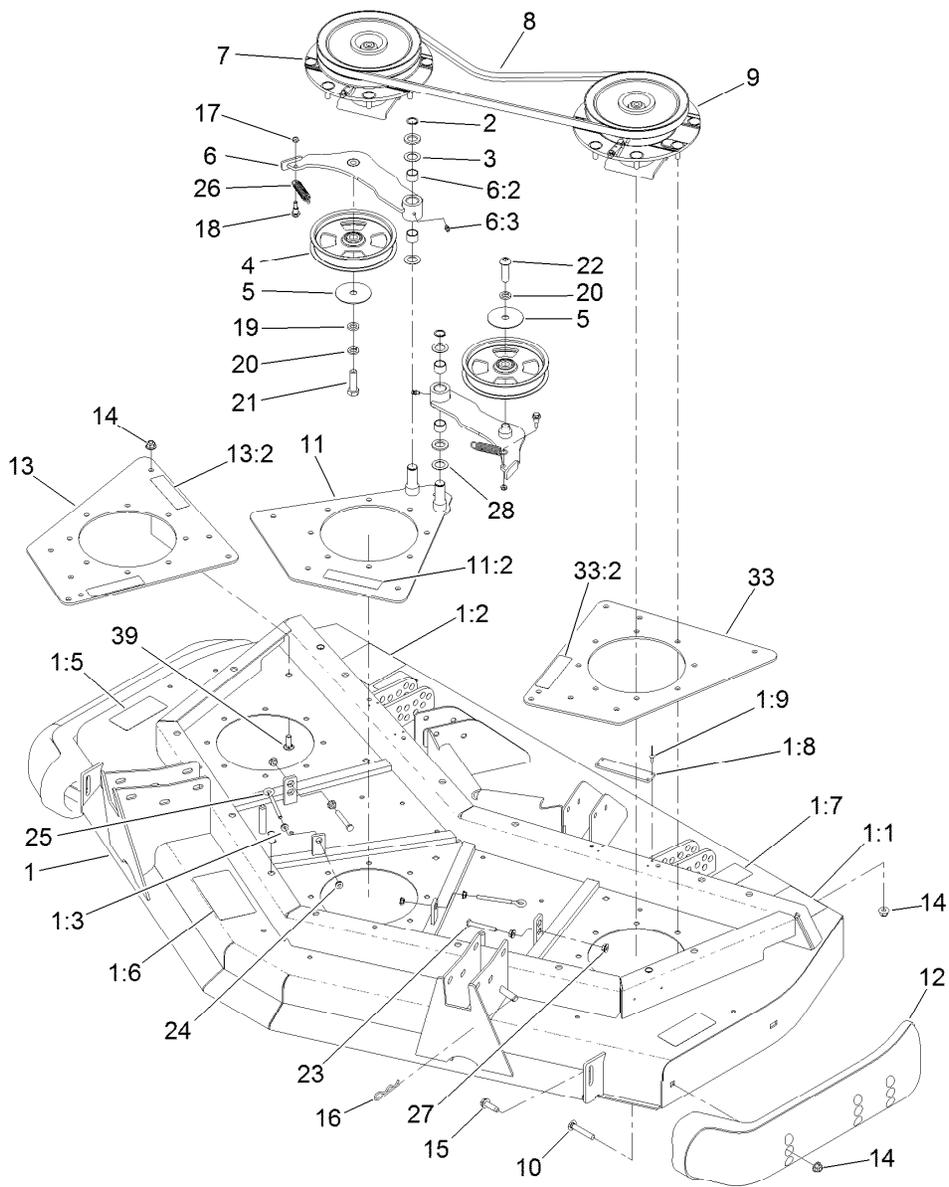

Front Deck Idler and Skid Assembly (continued)

Ref.	Part Number	Qty.	Description
33:2	100-6578	1	Decal-Danger
39	3231-22	12	Screw-CARR

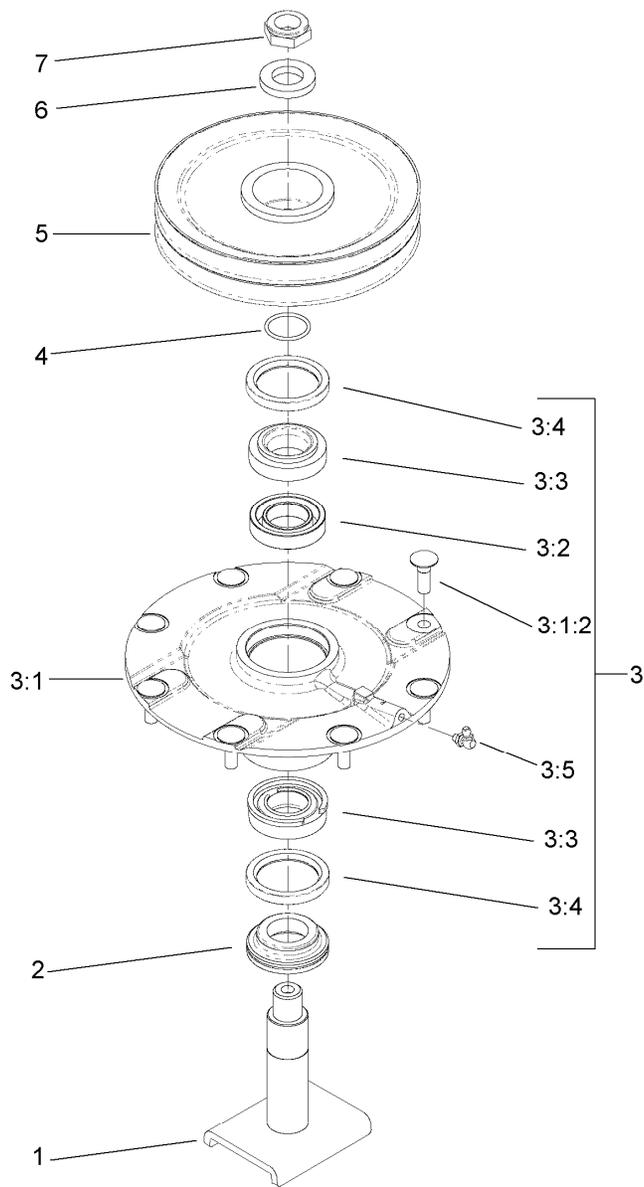

Double Driven Spindle Assembly No. 119-4548

Ref.	Part Number	Qty.	Description
1	104-3554	1	Shaft-Spindle
2	69-6950	1	Spacer-Shaft, Spindle
3	119-4775	1	Spindle Housing ASM
3:1		1	Spindle ASM ●
3:1:2	114-8195	8	Bolt-Neck, Ribbed
3:2	120-5577	1	Bearing Spacer Set
3:3	110-8297	1	Bearing ASM
3:4	253-154	2	Seal-Oil
3:5	302-60	1	Fitting-Grease
4	106-7159	1	O-Ring
5	104-3547	1	Pulley-Driven, Double
6	120-5576	1	Washer-Hardened
7	3296-60	1	Nut-Lock, NI

● Not serviced separately

High Driven Spindle Assembly No. 119-4549

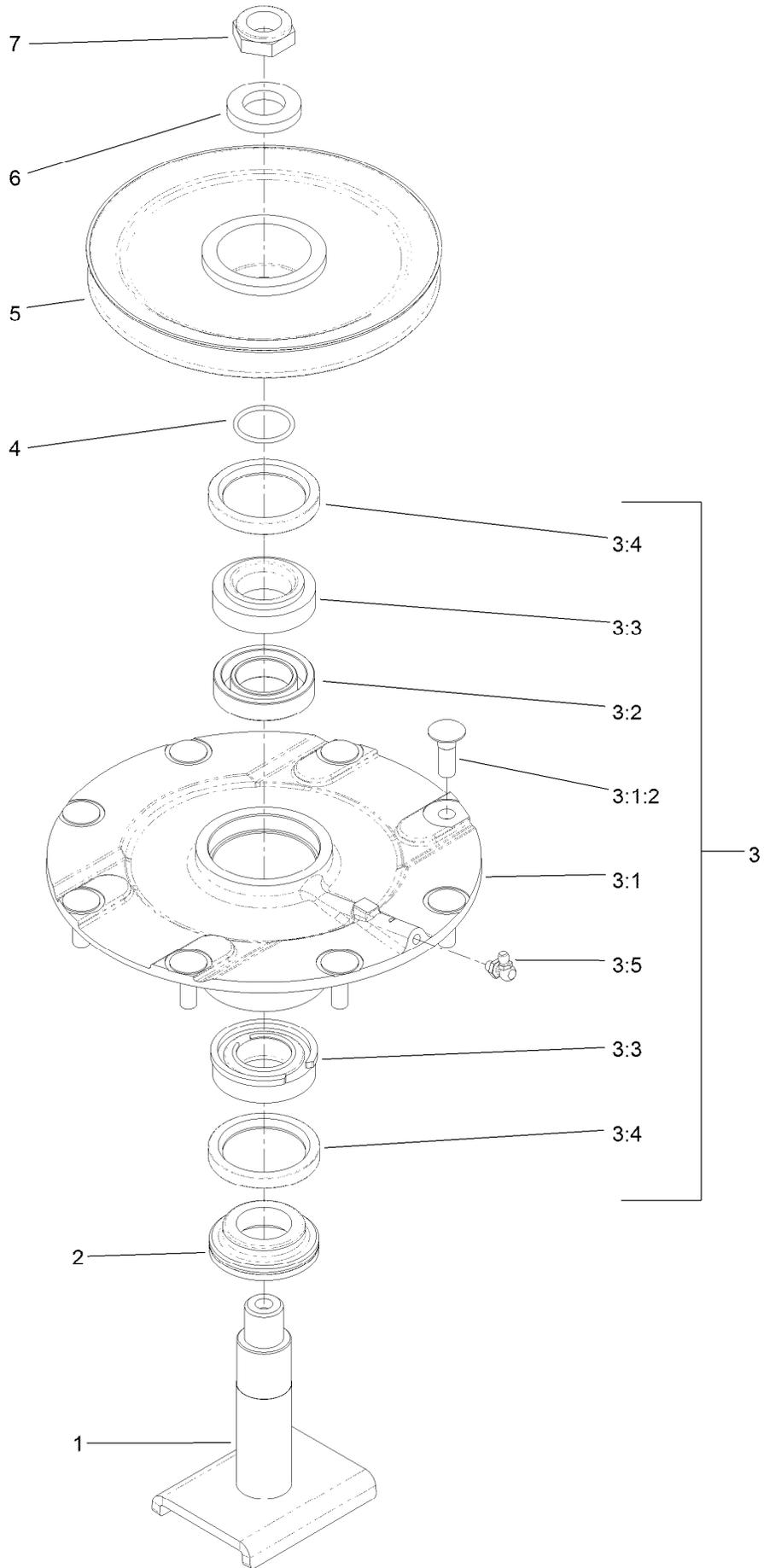

High Driven Spindle Assembly No. 119-4549 (continued)

<i>Ref.</i>	<i>Part Number</i>	<i>Qty.</i>	<i>Description</i>	<i>Ref.</i>	<i>Part Number</i>	<i>Qty.</i>	<i>Description</i>
1	104-3554	1	Shaft-Spindle	3:4	253-154	2	Seal-Oil
2	69-6950	1	Spacer-Shaft, Spindle	3:5	302-60	1	Fitting-Grease
3	119-4775	1	Spindle Housing ASM	4	106-7159	1	O-Ring
3:1		1	Spindle ASM ●	5	104-3548	1	Pulley-Driven, High
3:1:2	114-8195	8	Bolt-Neck, Ribbed	6	120-5576	1	Washer-Hardened
3:2	120-5577	1	Bearing Spacer Set	7	3296-60	1	Nut-Lock, NI
3:3	110-8297	1	Bearing ASM				

● Not serviced separately

Front Deck Caster Arm and Wheel Assembly

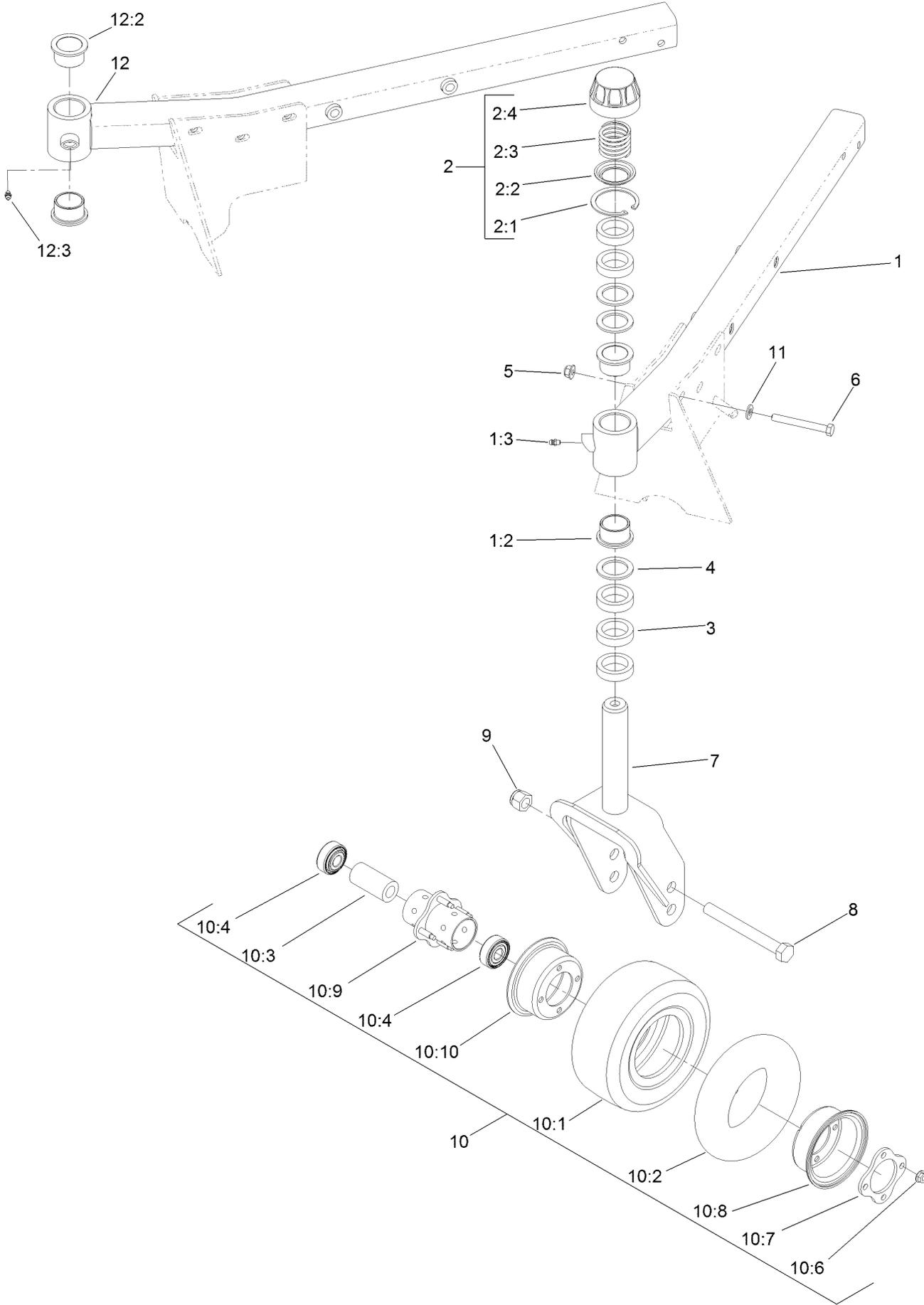

Front Deck Caster Arm and Wheel Assembly (continued)

<i>Ref.</i>	<i>Part Number</i>	<i>Qty.</i>	<i>Description</i>	<i>Ref.</i>	<i>Part Number</i>	<i>Qty.</i>	<i>Description</i>
1	132-6169	1	LH Caster Arm ASM	10	93-9938	2	Wheel ASM
1:2	69-6470	2	Bushing-Caster	10:1	93-9939	1	Tire
1:3	302-5	1	Fitting-Grease	10:2	68-8950	1	Tube-Inner (W/Valve)
2	92-9727	2	HOC Cap ASM	10:3	93-4241	1	Spacer-Bearing, Inner
2:1	92-5581	1	Ring-Rtng, Snap, Int, Flat	10:4	120-3366	2	Bearing
2:2	92-5583	1	Washer-Cap	10:6	32128-16	4	Nut-HHF
2:3	92-9726	1	Spring-Compression	10:7	93-4242	1	Plate
2:4	92-8861	1	Cap-HOC	10:8	93-4239	1	Rim-Wheel, Half
3	69-1510	10	Spacer	10:9	93-5980	1	Hub
4	69-6860	6	Washer-Thrust	10:10	95-2741	1	Rim-Wheel, Half
5	104-8301	10	Nut-HF, NI	11	3256-24	10	Washer-Plain
6	323-20	10	Screw-HH	12	132-6176	1	RH Caster Arm ASM
7	130-2736-01	2	Fork-Caster	12:2	69-6470	2	Bushing-Caster
8	327-24	2	Screw-HH	12:3	302-5	1	Fitting-Grease
9	3296-53	2	Nut-Lock, NI				
10	93-5974	2	8 Inch Foam Filled Wheel ASM ●				

● Optional Equipment

Driving Spindle Assembly

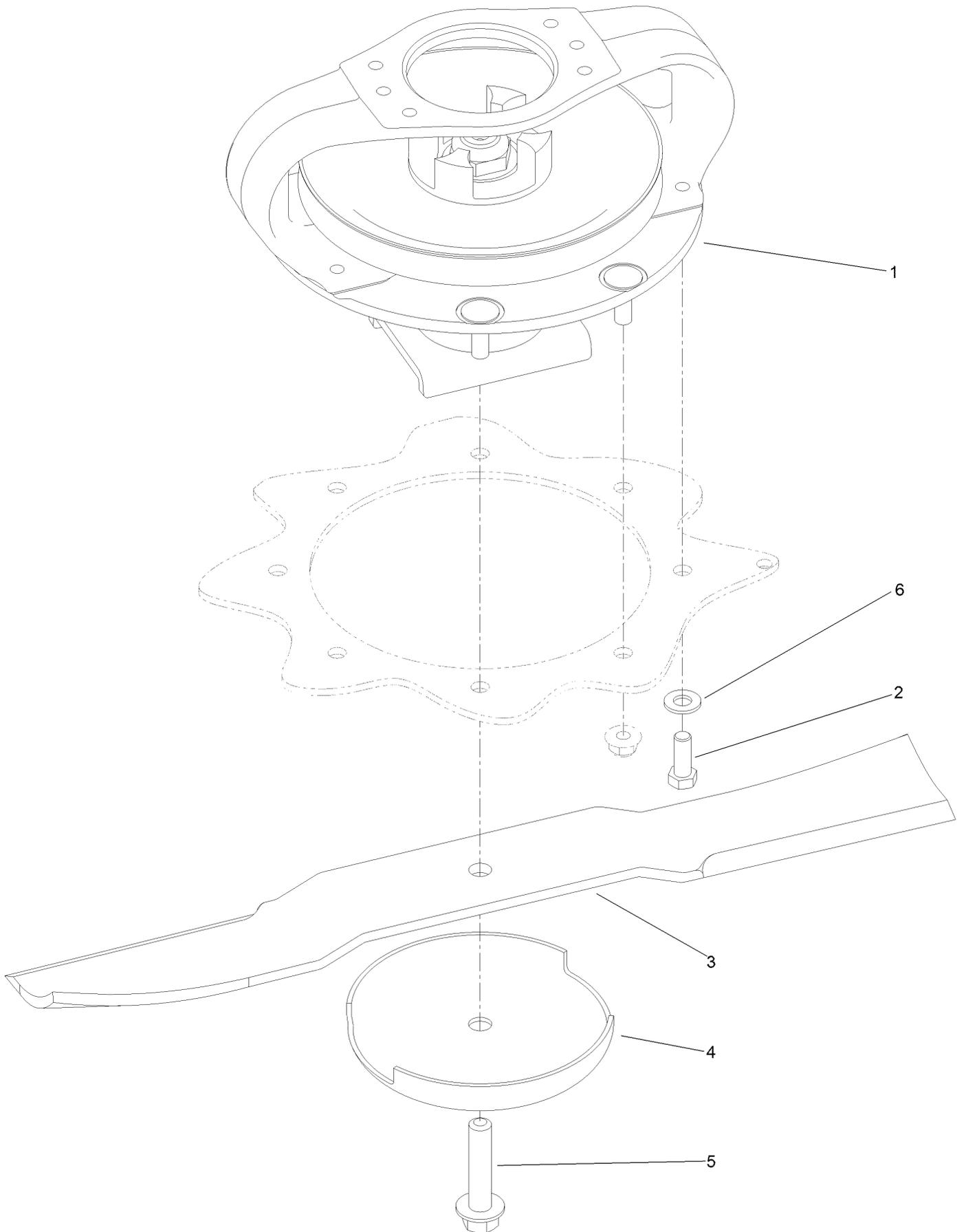

Driving Spindle Assembly (continued)

<i>Ref.</i>	<i>Part Number</i>	<i>Qty.</i>	<i>Description</i>	<i>Ref.</i>	<i>Part Number</i>	<i>Qty.</i>	<i>Description</i>
1	119-4547	1	Driving Spindle ASM	4	72-9361	3	Cup-Scalp, Anti
2	323-6	4	Screw-HH	5	92-5816	3	Bolt-Blade
3	92-5608-03	3	Blade	6	3256-24	4	Washer-Plain

Driven Spindle Assembly No. 119-4547

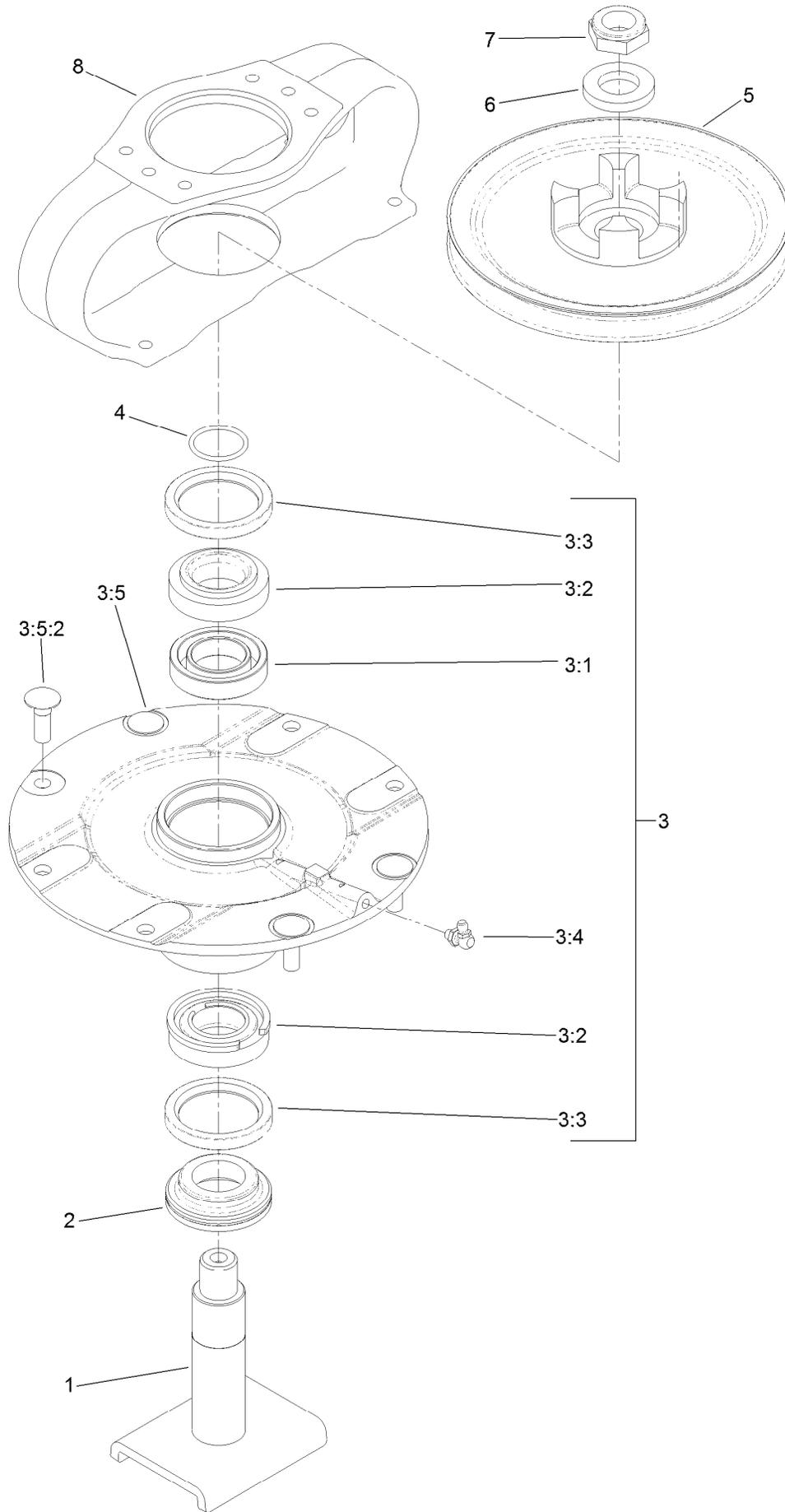

Driven Spindle Assembly No. 119-4547 (continued)

<i>Ref.</i>	<i>Part Number</i>	<i>Qty.</i>	<i>Description</i>	<i>Ref.</i>	<i>Part Number</i>	<i>Qty.</i>	<i>Description</i>
1	104-3554	1	Shaft-Spindle	3:5		1	Spindle ASM ●
2	69-6950	1	Spacer-Shaft, Spindle	3:5:2	114-8195	4	Bolt-Neck, Ribbed
3	119-4546	1	Spindle Housing ASM	4	106-7159	1	O-Ring
3:1	120-5577	1	Bearing Spacer Set	5	104-3545	1	Pulley-Driving
3:2	110-8297	1	Bearing ASM	6	120-5576	1	Washer-Hardened
3:3	253-154	2	Seal-Oil	7	3296-60	1	Nut-Lock, NI
3:4	302-60	1	Fitting-Grease	8	104-3544	1	Mount-Motor, Drive

● Not serviced separately

Cutting Chamber, Cover and Roller Assembly

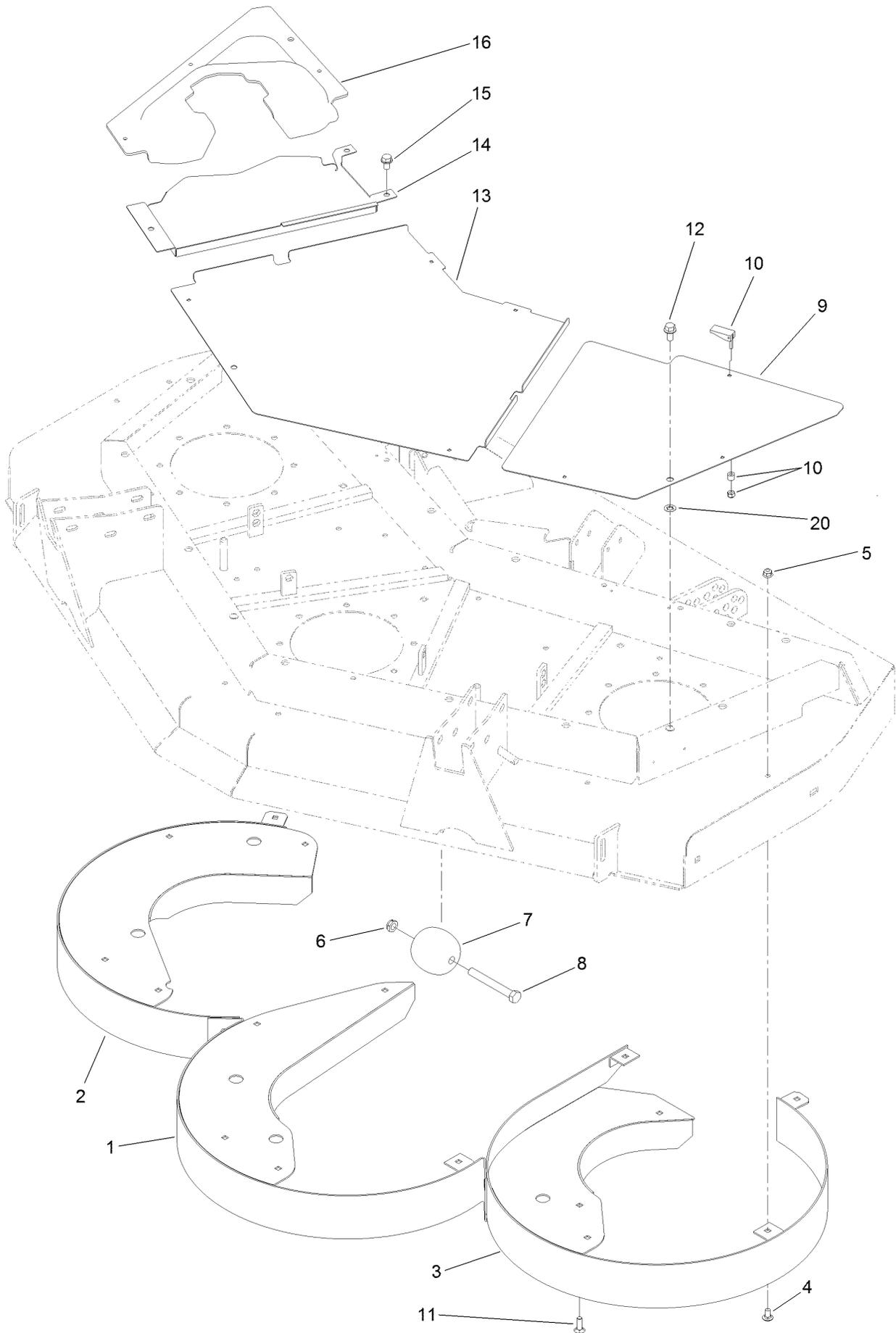

Cutting Chamber, Cover and Roller Assembly (continued)

<i>Ref.</i>	<i>Part Number</i>	<i>Qty.</i>	<i>Description</i>	<i>Ref.</i>	<i>Part Number</i>	<i>Qty.</i>	<i>Description</i>
1	130-2650-01	1	Chamber-Center	10	74-5950	10	Latch-Swell
2	130-2674-01	1	Chamber-RH	11	3230-22	3	Screw-CARR
3	130-2675-01	1	Chamber-LH	12	3234-1	3	Screw-HHF
4	3230-18	15	Screw-CARR	13	100-5660-03	1	Cover-Front, Center
5	104-8300	18	Nut-HF, NI	14	100-5662-03	1	Cover-Front, RH
6	3296-45	2	Nut-Hex	15	32144-69	3	Screw-HWHTF
7	29-4820	2	Roller	16	100-5661	1	Cover-Front, Center
8	325-17	2	Screw-HH	20	107-3154	3	Nut-Push
9	100-5663-03	1	Cover-Front, LH				

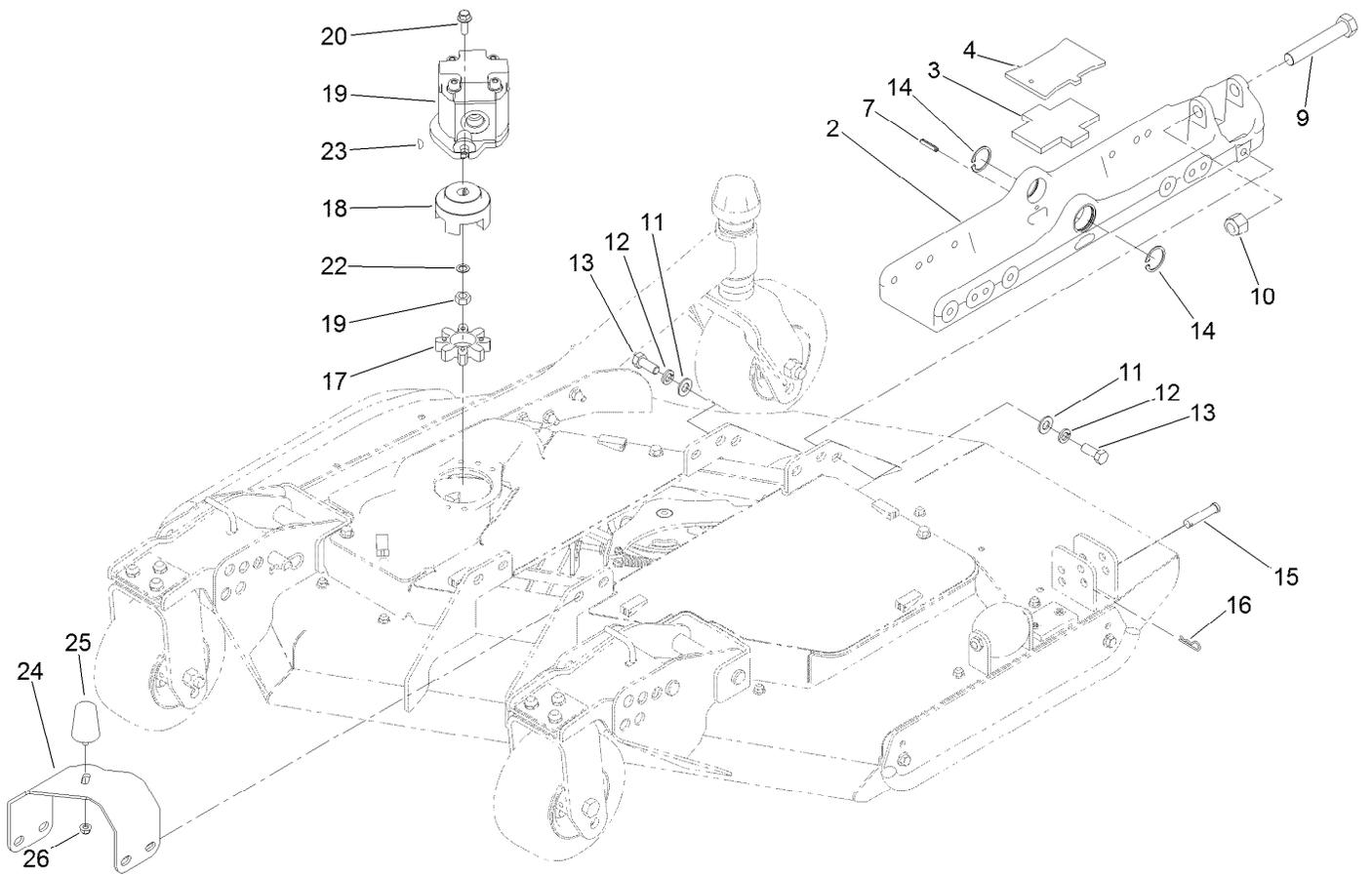

Right Deck Mount Assembly

<i>Ref.</i>	<i>Part Number</i>	<i>Qty.</i>	<i>Description</i>	<i>Ref.</i>	<i>Part Number</i>	<i>Qty.</i>	<i>Description</i>
2	136-0033-03	1	Mount-Deck	16	3290-467	1	Pin-Hair
3	104-8348	1	Plate-Rubber	17	104-3542	1	Spider
4	136-0041-03	1	Plate	18	104-3541	1	Hub-Spider
7	32121-69	1	Pin-Roll	19	127-3694	1	HYD Motor ASM
9	328-8	1	Screw-HH	20	3234-42	2	Screw-HHF
10	3296-51	1	Nut-Lock, NI	22	112-6957	1	Washer-Hardened
11	3256-26	8	Washer-Flat	23	3257-3	1	Key-Woodruff
12	3253-7	8	Washer-Lock	24	130-5966-03	1	Bracket-Bumper, RH
13	325-5	8	Screw-HH	25	110-5070	1	Bumper
14	32120-42	2	Ring-Retaining	26	104-8300	1	Nut-HF, NI
15	92-2739	1	Pin-Clevis				

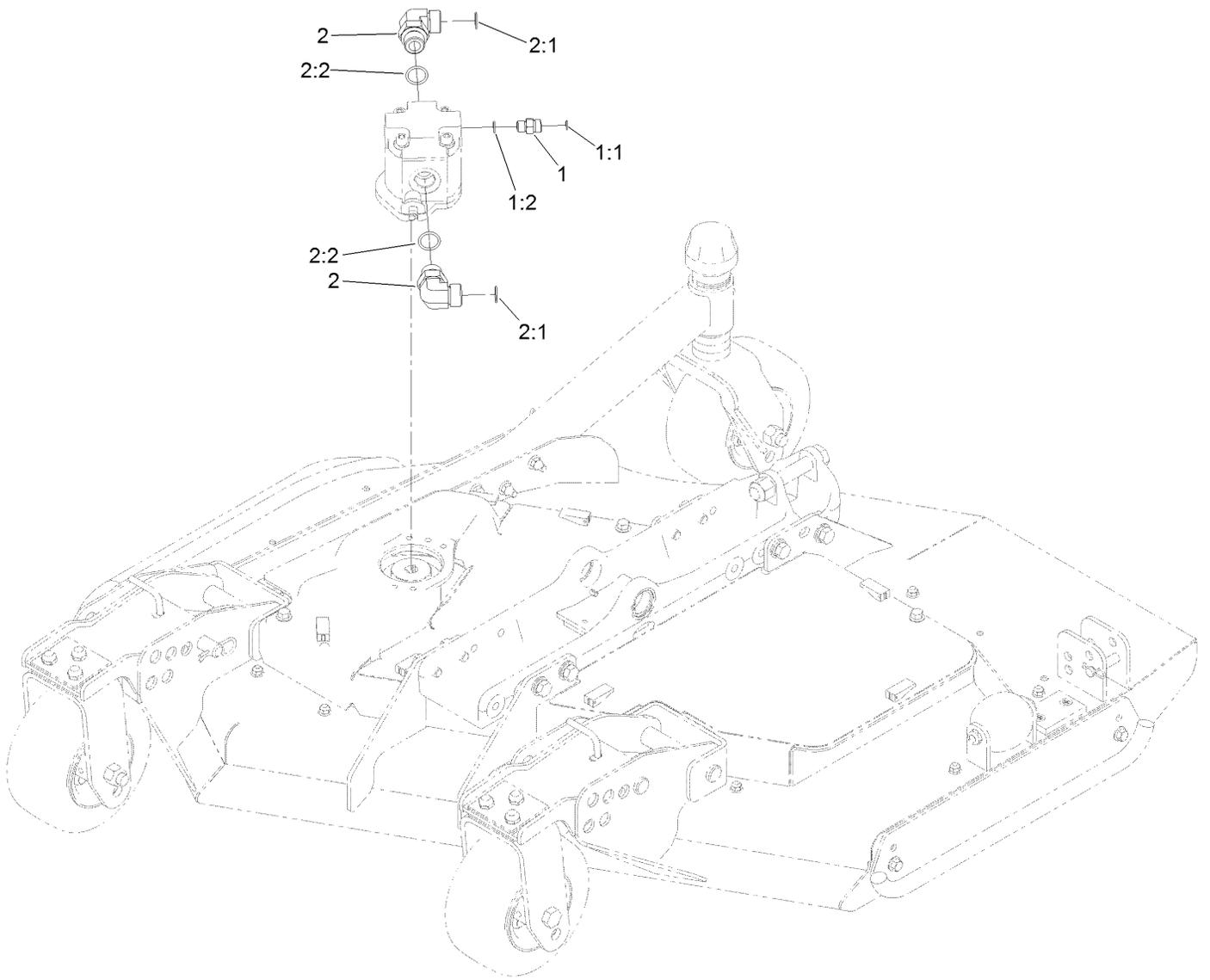

Right Deck Hydraulic Fitting Assembly

<i>Ref.</i>	<i>Part Number</i>	<i>Qty.</i>	<i>Description</i>
1	340-2	1	Fitting-Straight
1:1	237-22	1	O-Ring
1:2	237-42	1	O-Ring
2	340-142	2	Fitting-Elbow, 90 DEG
2:1	237-58	1	O-Ring
2:2	237-81	1	O-Ring

Right Deck Hose Assembly

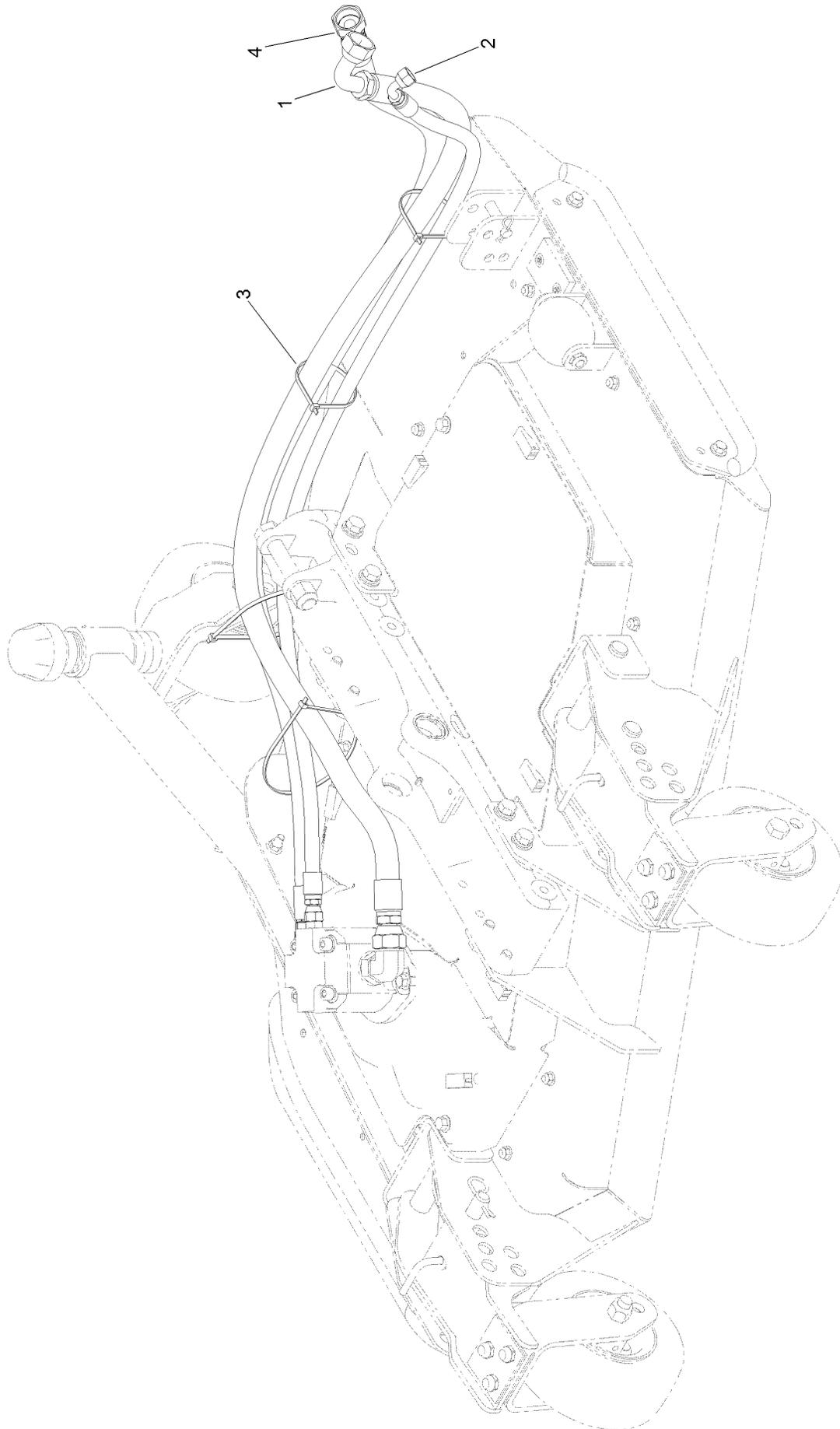

Right Deck Hose Assembly (continued)

<i>Ref.</i>	<i>Part Number</i>	<i>Qty.</i>	<i>Description</i>	<i>Ref.</i>	<i>Part Number</i>	<i>Qty.</i>	<i>Description</i>
1	120-8959	1	Hose-HYD	3	3290-379	4	Tie-Cable
2	104-2265	1	Hose-HYD	4	132-6116	1	Hose-HYD

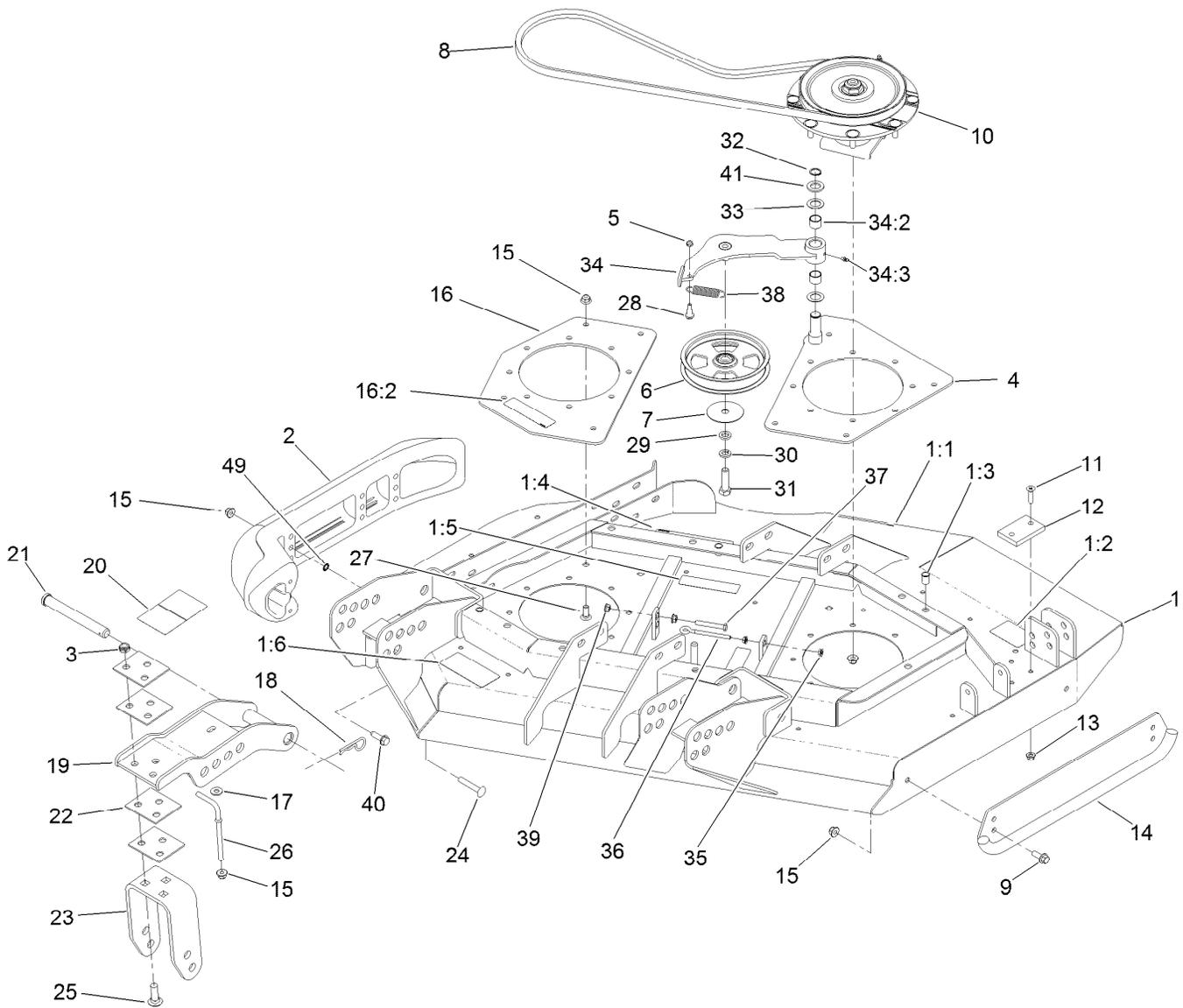

Right Deck, Idler and Skid Assembly

Ref.	Part Number	Qty.	Description	Ref.	Part Number	Qty.	Description
1	131-1235	1	Right Deck ASM	16	131-1243	1	Plate-Spindle
1:1	120-6604	1	Decal-Danger	16:2	100-6578	1	Decal-Danger
1:2	100-5694	1	Decal-Rear HOC, RH	17	3256-3	2	Washer-Flat
1:3	32148-9	3	Nut-Clinch	18	3290-343	4	Pin-Hair
1:4	100-5622	1	Decal-HOC	19	132-6150-01	2	Bracket-Caster
1:5	100-6578	2	Decal-Danger	20	100-5623	1	Decal-HOC
1:6	93-7818	1	Decal-Torque, Blade Bolt	21	120-5587	4	Pin-Clevis
2	112-1479	1	Skid-Bumper, Deck	22	104-7524	8	Shim
3	3296-45	6	Nut-Hex	23	132-6157-01	2	Bracket-Fork
4	131-1231-01	1	Plate-Stiffener	24	3231-33	2	Screw-CARR
5	3296-56	1	Nut-Lock, NI	25	3233-2	6	Screw-CARR
6	132-9421	1	Pulley-Idler, Flat	26	106-2047	2	Rod-Tension
7	100-3102	1	Washer-Flat	27	3231-22	8	Screw-CARR
8	108-8076	1	V-Belt, Deck	28	104-0858	1	Bolt-Shoulder
9	3234-42	2	Screw-HHF	29	9202424	1	Spacer
10	119-4776	1	Low-Driven Spindle ASM	30	3253-7	1	Washer-Lock
11	32108-103	2	Screw-FH	31	325-7	1	Screw-HH
12	69-9290	1	Pad-Bumper	32	32120-72	1	Ring-Snap
13	104-8300	2	Nut-HF, NI	33	3-6498	2	Washer-Thrust
14	104-2250-01	1	Skid-Side	34	110-6128	1	Idler Arm ASM
15	104-8301	26	Nut-HF, NI	34:2	256-76	2	Bushing

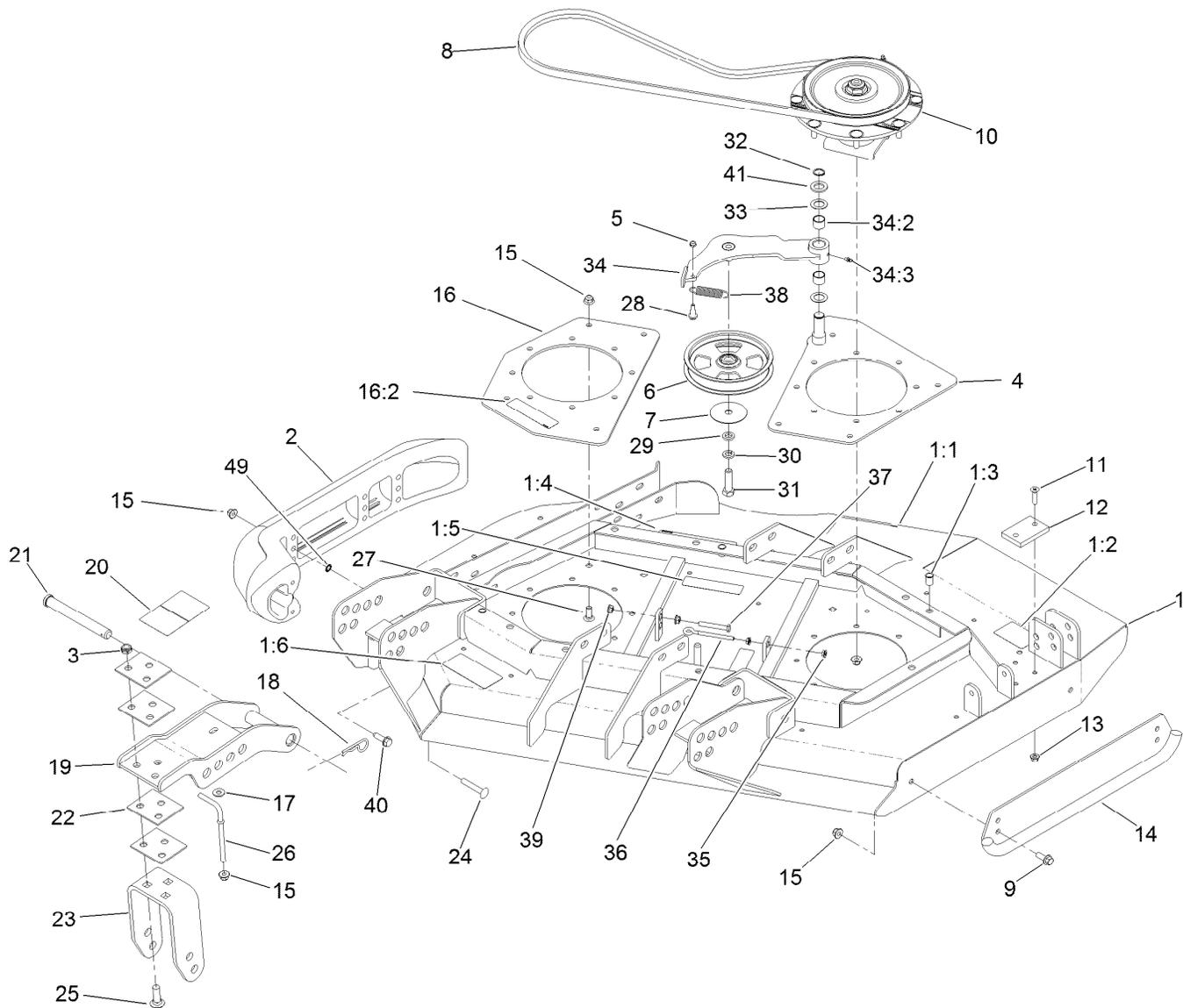

Right Deck, Idler and Skid Assembly (continued)

<i>Ref.</i>	<i>Part Number</i>	<i>Qty.</i>	<i>Description</i>	<i>Ref.</i>	<i>Part Number</i>	<i>Qty.</i>	<i>Description</i>
34:3	302-5	1	Fitting-Grease	39	32128-26	2	Nut-HF
35	32128-14	2	Nut-HF	40	9136144	1	Screw-HWHTF
36	68-0090	1	Screw-Adjusting	41	70-1160	1	Washer
37	9114524	1	Bolt-TAP, HH	49	32151-72	2	Ring-Retaining
38	107938	1	Spring-Extension				

Low Driven Spindle Assembly No. 119-4776

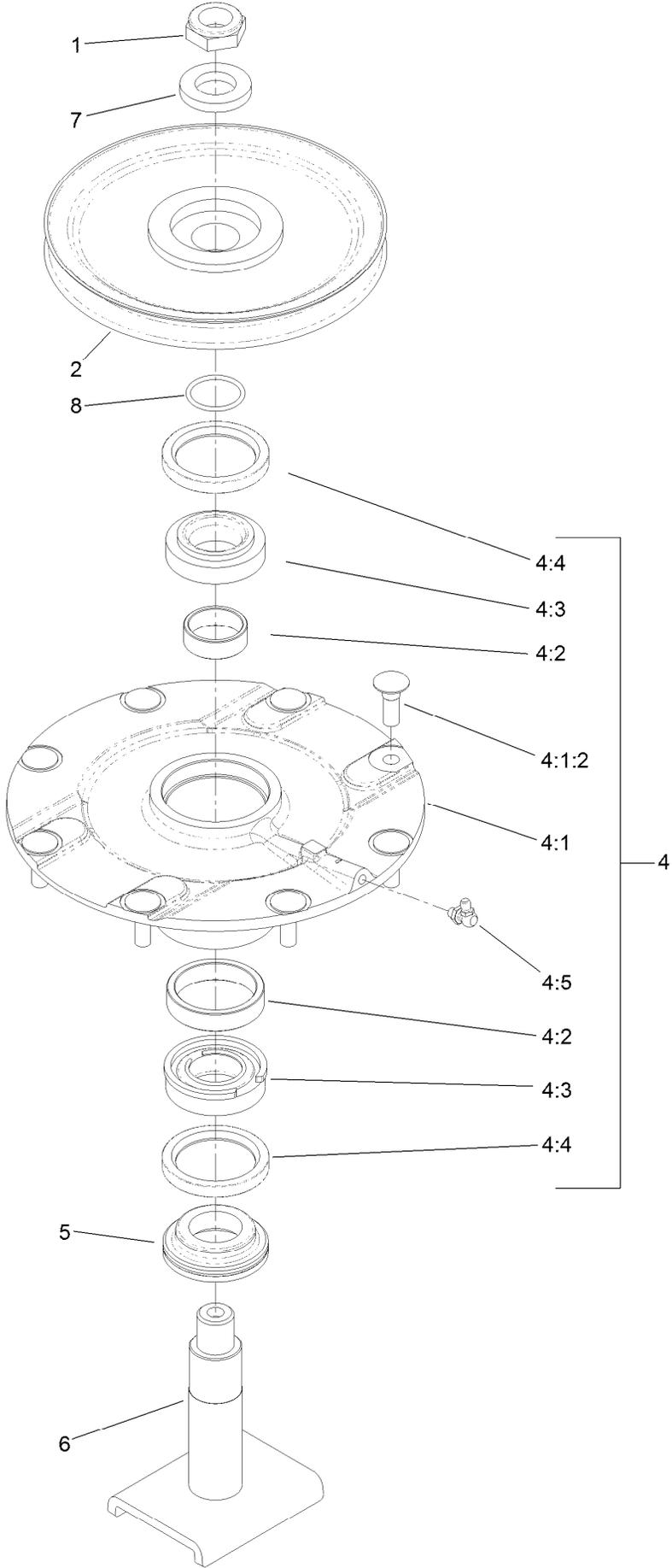

Low Driven Spindle Assembly No. 119-4776 (continued)

<i>Ref.</i>	<i>Part Number</i>	<i>Qty.</i>	<i>Description</i>	<i>Ref.</i>	<i>Part Number</i>	<i>Qty.</i>	<i>Description</i>
1	3296-60	1	Nut-Lock, NI	4:4	253-154	2	Seal-Oil
2	104-3546	1	Pulley-Driven, Low	4:5	302-60	1	Fitting-Grease
4	119-4775	1	Spindle Housing ASM	5	69-6950	1	Spacer-Shaft, Spindle
4:1		1	Spindle ASM ●	6	104-3554	1	Shaft-Spindle
4:1:2	114-8195	8	Bolt-Neck, Ribbed	7	120-5576	1	Washer-Hardened
4:2	120-5577	1	Bearing Spacer Set	8	106-7159	1	O-Ring
4:3	110-8297	1	Bearing ASM				

● Not serviced separately

Right Hand and Left Hand Castor Arm and Wheel Assembly

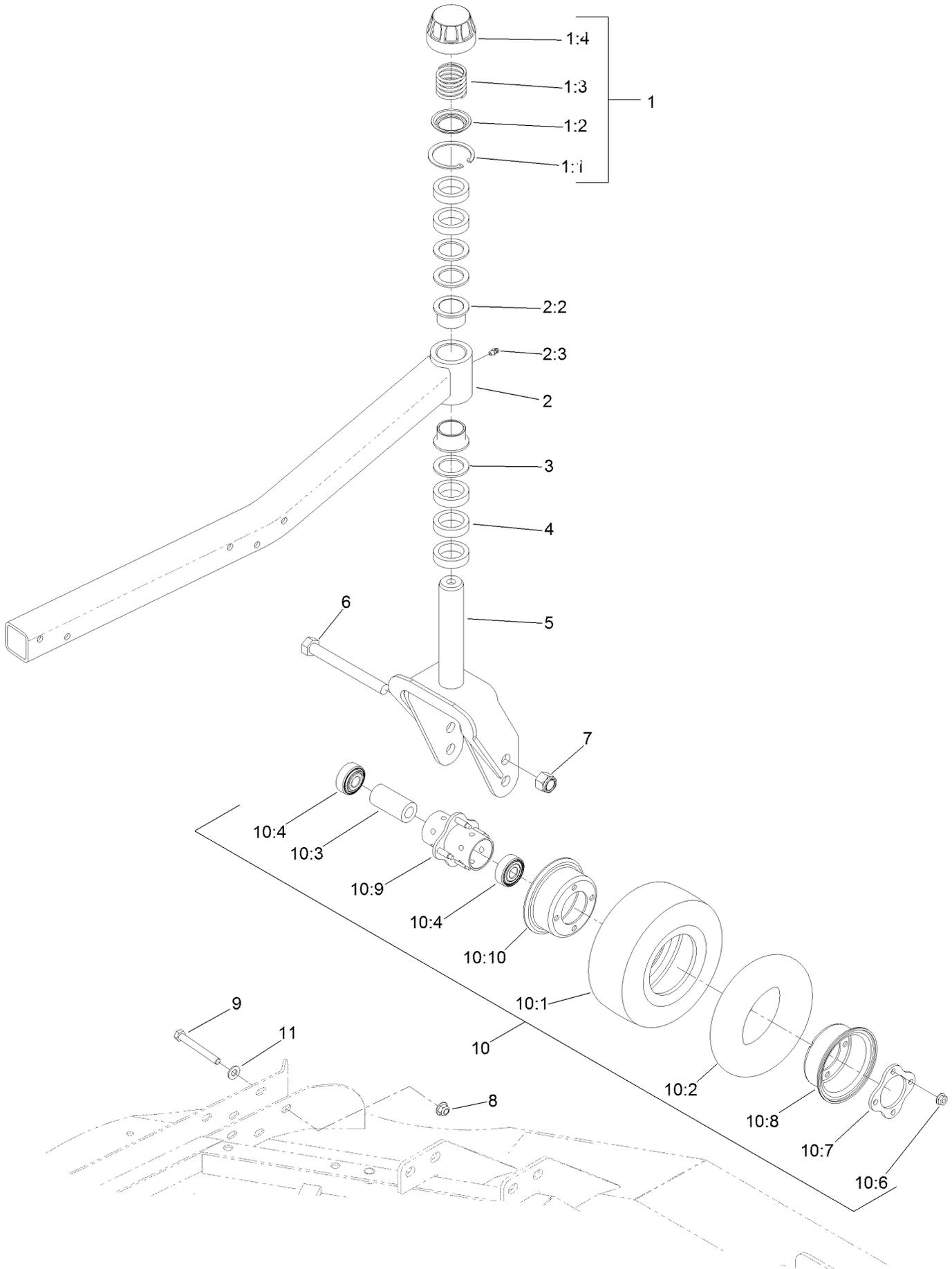

Right Hand and Left Hand Castor Arm and Wheel Assembly (continued)

<i>Ref.</i>	<i>Part Number</i>	<i>Qty.</i>	<i>Description</i>	<i>Ref.</i>	<i>Part Number</i>	<i>Qty.</i>	<i>Description</i>
1	92-9727	1	HOC Cap ASM	9	323-20	5	Screw-HH
1:1	92-5581	1	Ring-Rtng, Snap, Int, Flat	10	93-5974	3	8 Inch Foam Filled Wheel ASM ●
1:2	92-5583	1	Washer-Cap				
1:3	92-9726	1	Spring-Compression	10	93-9938	3	Wheel ASM
1:4	92-8861	1	Cap-HOC	10:1	93-9939	1	Tire
2	132-6167	1	Caster Arm ASM	10:2	68-8950	1	Tube-Inner (W/Valve)
2:2	69-6470	2	Bushing-Caster	10:3	93-4241	1	Spacer-Bearing, Inner
2:3	302-5	1	Fitting-Grease	10:4	120-3366	2	Bearing
3	69-6860	3	Washer-Thrust	10:6	32128-16	4	Nut-HHF
4	69-1510	5	Spacer	10:7	93-4242	1	Plate
5	130-2736-01	1	Fork-Caster	10:8	93-4239	1	Rim-Wheel, Half
6	327-24	3	Screw-HH	10:9	93-5980	1	Hub
7	3296-53	3	Nut-Lock, NI	10:10	95-2741	1	Rim-Wheel, Half
8	104-8301	5	Nut-HF, NI	11	3256-24	5	Washer-Plain

● Optional Equipment

LH and RH Deck Driving Spindle Assembly

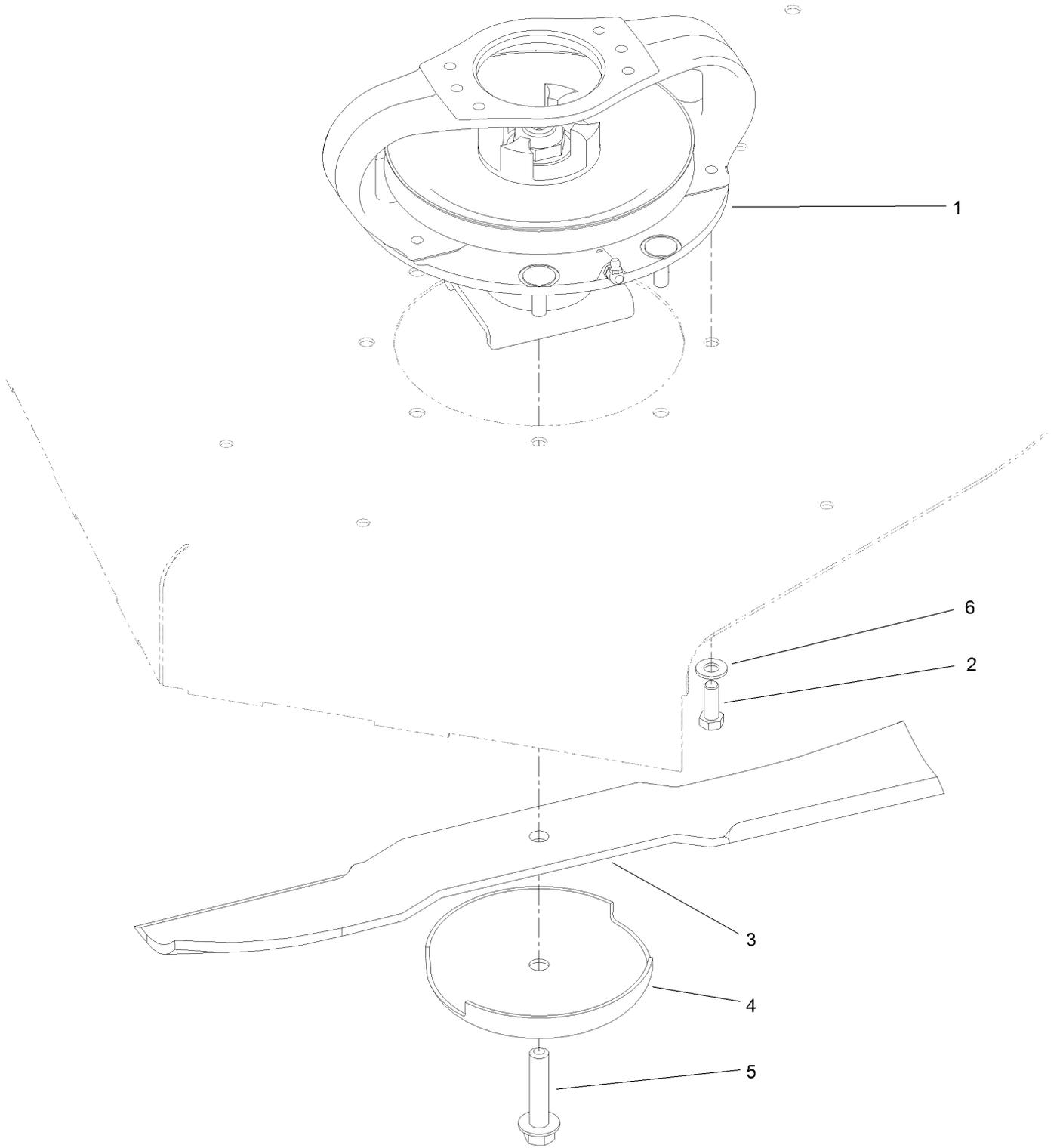

LH and RH Deck Driving Spindle Assembly (continued)

<i>Ref.</i>	<i>Part Number</i>	<i>Qty.</i>	<i>Description</i>
1	119-4547	1	Driving Spindle ASM
2	323-6	4	Screw-HH
3	92-5608-03	2	Blade

<i>Ref.</i>	<i>Part Number</i>	<i>Qty.</i>	<i>Description</i>
4	72-9361	2	Cup-Scalp, Anti
5	92-5816	2	Bolt-Blade
6	3256-24	4	Washer-Plain

Right Deck Discharge Chamber and Cover Assembly

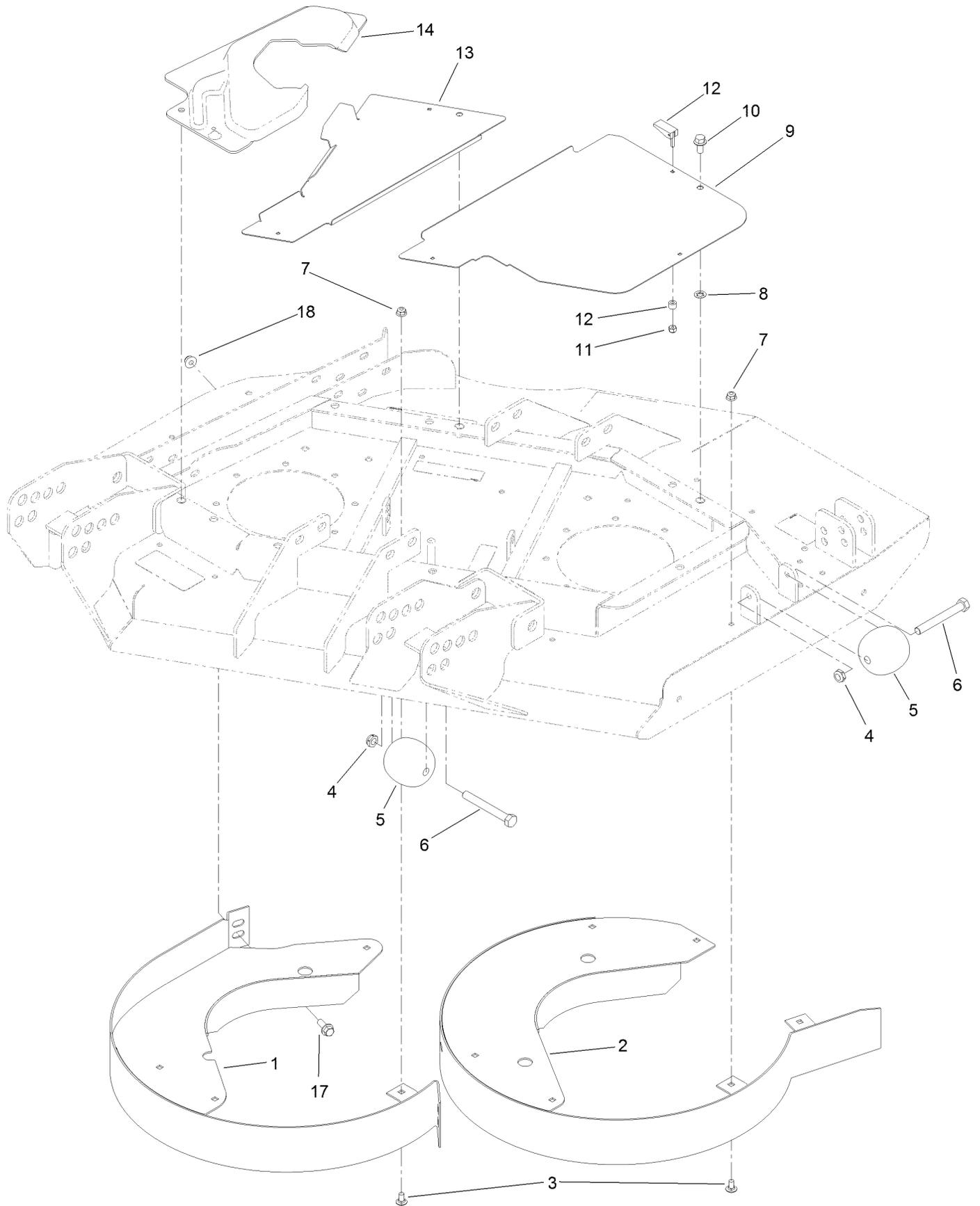

Right Deck Discharge Chamber and Cover Assembly (continued)

<i>Ref.</i>	<i>Part Number</i>	<i>Qty.</i>	<i>Description</i>	<i>Ref.</i>	<i>Part Number</i>	<i>Qty.</i>	<i>Description</i>
1	130-2680-01	1	Chamber-Outer	9	100-5668-03	1	Plate-Cover, RH Side
2	130-2681-01	1	Chamber-Inner	10	3234-1	3	Screw-HHF
3	3230-18	11	Screw-CARR	11	1-804254	7	Nut-Lock, HH
4	3296-45	2	Nut-Hex	12	74-5950	7	Latch-Swell
5	29-4820	2	Roller	13	100-5665-03	1	Plate-Cover, RH
6	325-17	2	Screw-HH	14	100-5666	1	Cover-Motor, RH Deck
7	104-8300	11	Nut-HF, NI	17	3234-42	1	Screw-HHF
8	107-3154	3	Nut-Push	18	104-8301	1	Nut-HF, NI

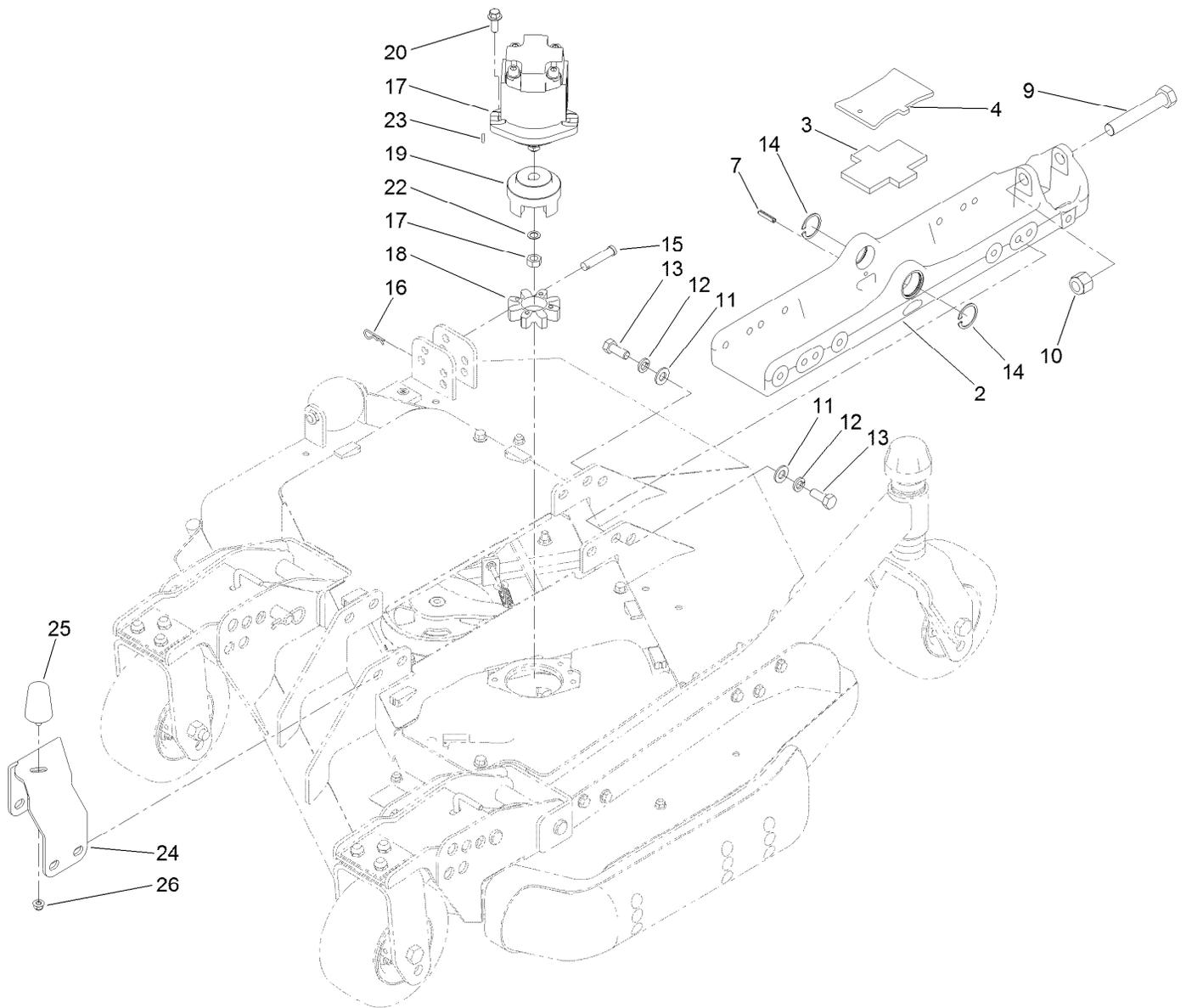

Left Deck Mount Assembly

<i>Ref.</i>	<i>Part Number</i>	<i>Qty.</i>	<i>Description</i>	<i>Ref.</i>	<i>Part Number</i>	<i>Qty.</i>	<i>Description</i>
2	136-0033-03	1	Mount-Deck	16	3290-467	1	Pin-Hair
3	104-8348	1	Plate-Rubber	17	127-3694	1	HYD Motor ASM
4	136-0041-03	1	Plate	18	104-3542	1	Spider
7	32121-69	1	Pin-Roll	19	104-3541	1	Hub-Spider
9	328-8	1	Screw-HH	20	3234-42	2	Screw-HHF
10	3296-51	1	Nut-Lock, NI	22	112-6957	1	Washer-Hardened
11	3256-26	8	Washer-Flat	23	3257-3	1	Key-Woodruff
12	3253-7	8	Washer-Lock	24	130-5965-03	1	Bracket-Bumper, LH
13	325-5	8	Screw-HH	25	110-5070	1	Bumper
14	32120-42	2	Ring-Retaining	26	104-8300	1	Nut-HF, NI
15	92-2739	1	Pin-Clevis				

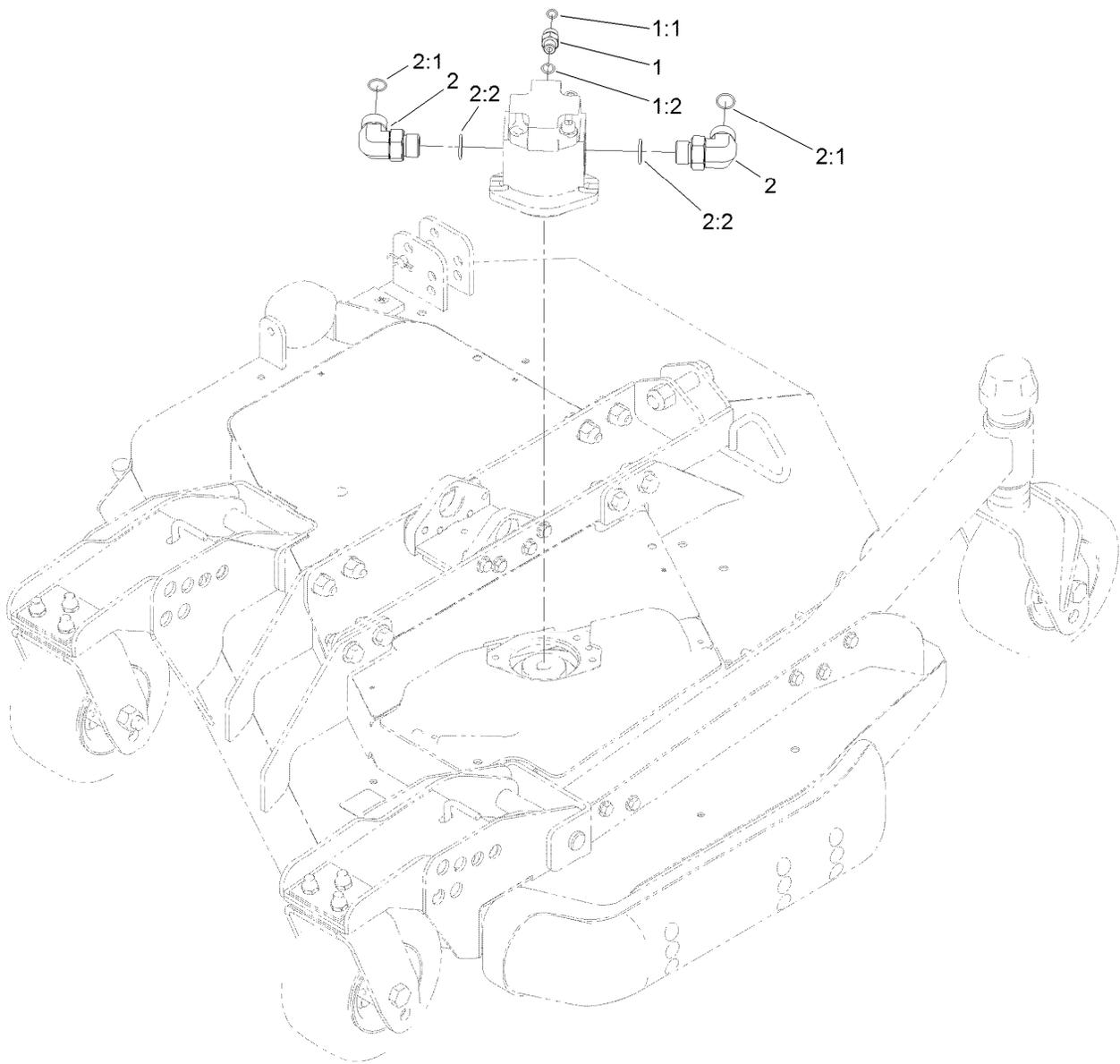

Left Deck Hydraulic Fitting Assembly

<i>Ref.</i>	<i>Part Number</i>	<i>Qty.</i>	<i>Description</i>
1	340-2	1	Fitting-Straight
1:1	237-22	1	O-Ring
1:2	237-42	1	O-Ring
2	340-142	2	Fitting-Elbow, 90 DEG
2:1	237-58	1	O-Ring
2:2	237-81	1	O-Ring

Left Deck Hose Assembly

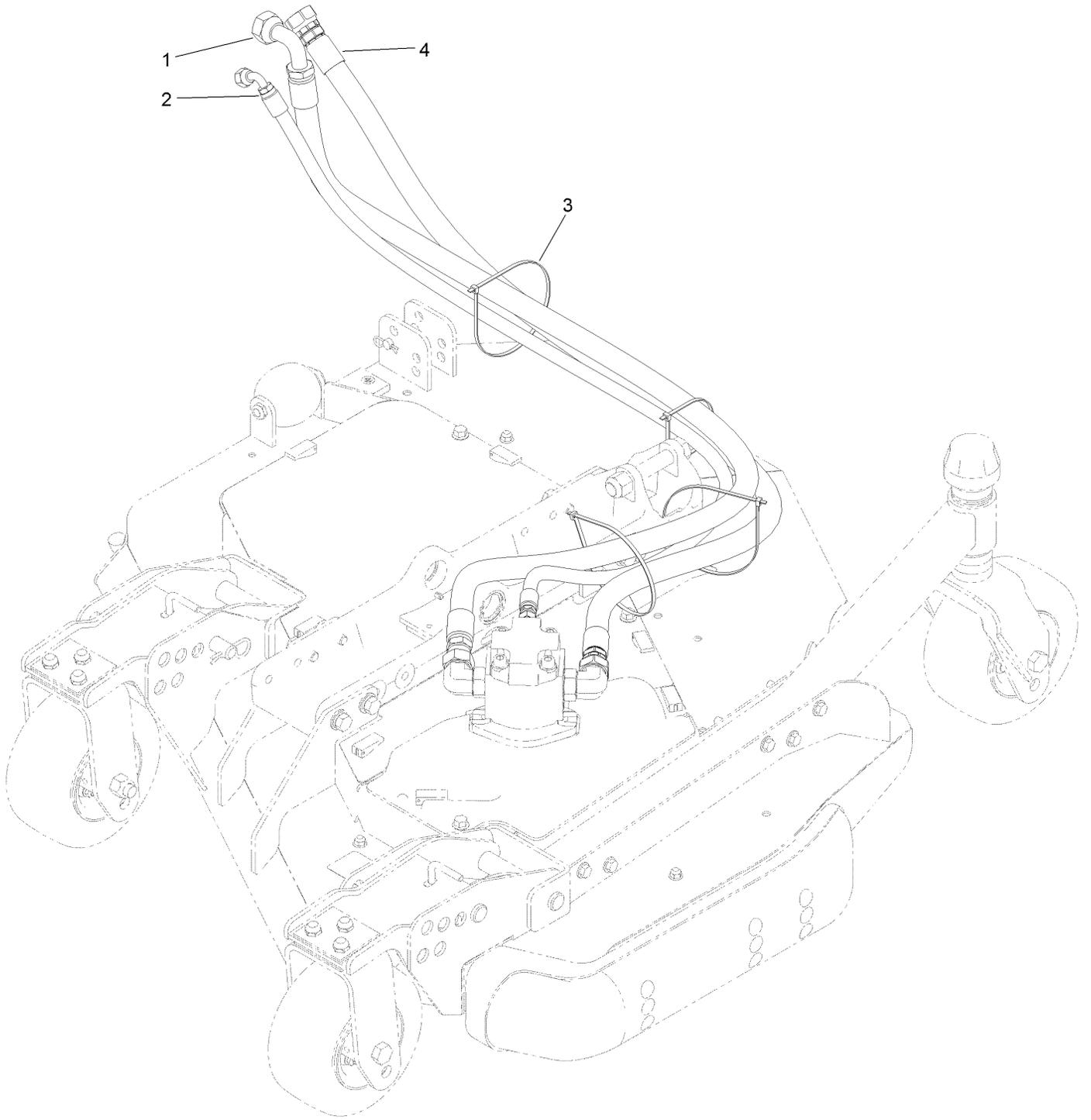

Left Deck Hose Assembly (continued)

<i>Ref.</i>	<i>Part Number</i>	<i>Qty.</i>	<i>Description</i>	<i>Ref.</i>	<i>Part Number</i>	<i>Qty.</i>	<i>Description</i>
1	120-8959	1	Hose-HYD	3	3290-379	4	Tie-Cable
2	104-2265	1	Hose-HYD	4	132-6116	1	Hose-HYD

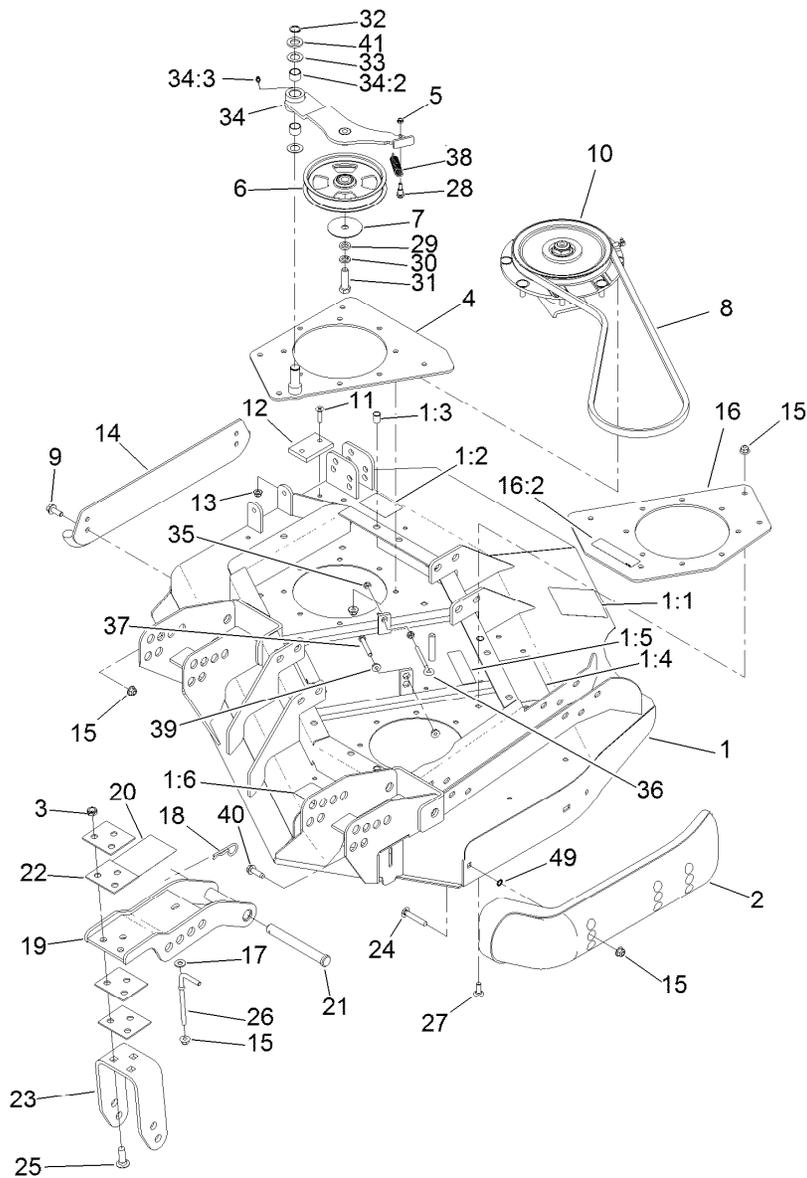

Left Deck, Idler and Skid Assembly

Ref.	Part Number	Qty.	Description	Ref.	Part Number	Qty.	Description
1	131-1236	1	Left Deck ASM	16	131-1244	1	Plate-Spindle
1:1	120-6604	1	Decal-Danger	16:2	100-6578	1	Decal-Danger
1:2	100-5693	1	Decal-Rear HOC, LH	17	3256-3	2	Washer-Flat
1:3	32148-9	3	Nut-Clinch	18	3290-343	4	Pin-Hair
1:4	100-5622	1	Decal-HOC	19	132-6150-01	2	Bracket-Caster
1:5	100-6578	2	Decal-Danger	20	104-3579	1	Decal-HOC
1:6	93-7818	1	Decal-Torque, Blade Bolt	21	120-5587	4	Pin-Clevis
2	112-1479	1	Skid-Bumper, Deck	22	104-7524	8	Shim
3	3296-45	6	Nut-Hex	23	132-6157-01	2	Bracket-Fork
4	131-1233-01	1	Plate-Stiffener	24	3231-33	2	Screw-CARR
5	3296-56	1	Nut-Lock, NI	25	3233-2	6	Screw-CARR
6	132-9421	1	Pulley-Idler, Flat	26	106-2047	2	Rod-Tension
7	100-3102	1	Washer-Flat	27	3231-22	8	Screw-CARR
8	108-8076	1	V-Belt, Deck	28	104-0858	1	Bolt-Shoulder
9	3234-42	2	Screw-HHF	29	9202424	1	Spacer
10	119-4776	1	Low-Driven Spindle ASM	30	3253-7	1	Washer-Lock
11	32108-103	2	Screw-FH	31	325-7	1	Screw-HH
12	69-9290	1	Pad-Bumper	32	32120-72	1	Ring-Snap
13	104-8300	2	Nut-HF, NI	33	3-6498	2	Washer-Thrust
14	104-2250-01	1	Skid-Side	34	110-6128	1	Idler Arm ASM
15	104-8301	26	Nut-HF, NI	34:2	256-76	2	Bushing

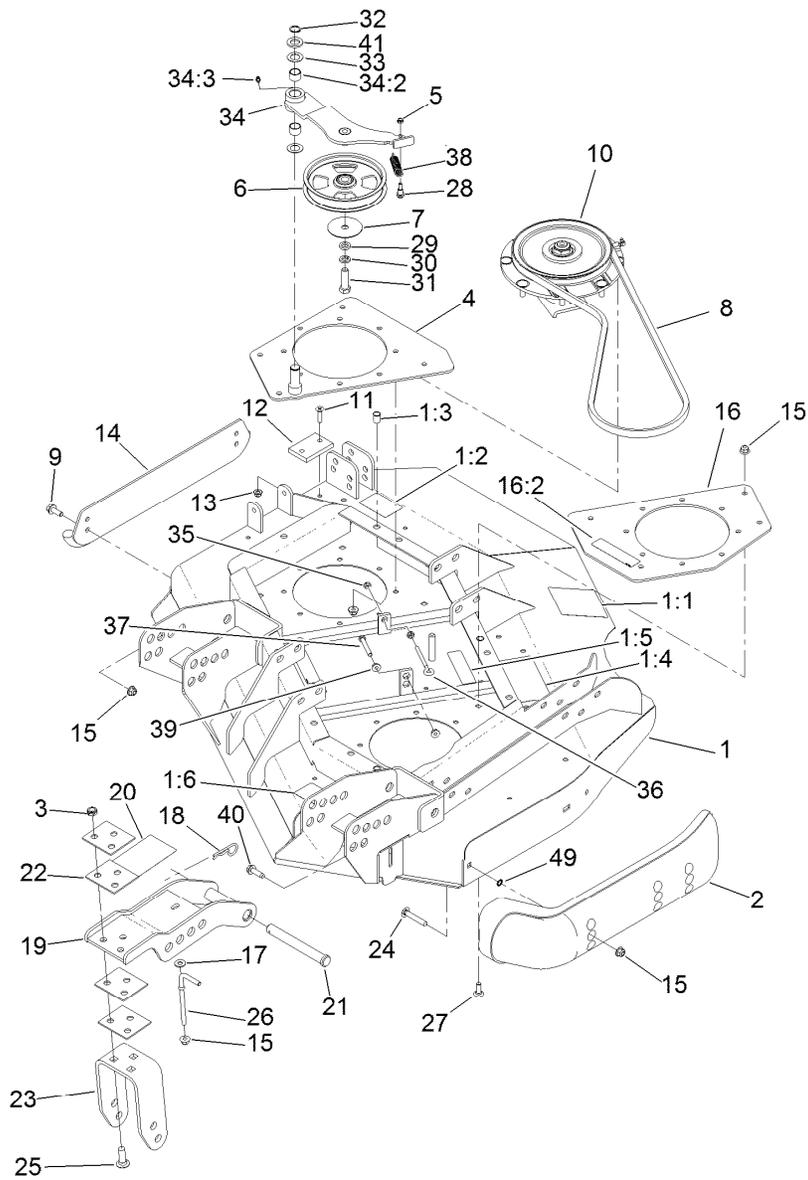

Left Deck, Idler and Skid Assembly (continued)

<i>Ref.</i>	<i>Part Number</i>	<i>Qty.</i>	<i>Description</i>	<i>Ref.</i>	<i>Part Number</i>	<i>Qty.</i>	<i>Description</i>
34:3	302-5	1	Fitting-Grease	39	32128-26	2	Nut-HF
35	32128-14	2	Nut-HF	40	9136144	1	Screw-HWHTF
36	68-0090	1	Screw-Adjusting	41	70-1160	1	Washer
37	9114524	1	Bolt-TAP, HH	49	32151-72	2	Ring-Retaining
38	107938	1	Spring-Extension				

Left Deck Discharge Chamber and Cover Assembly

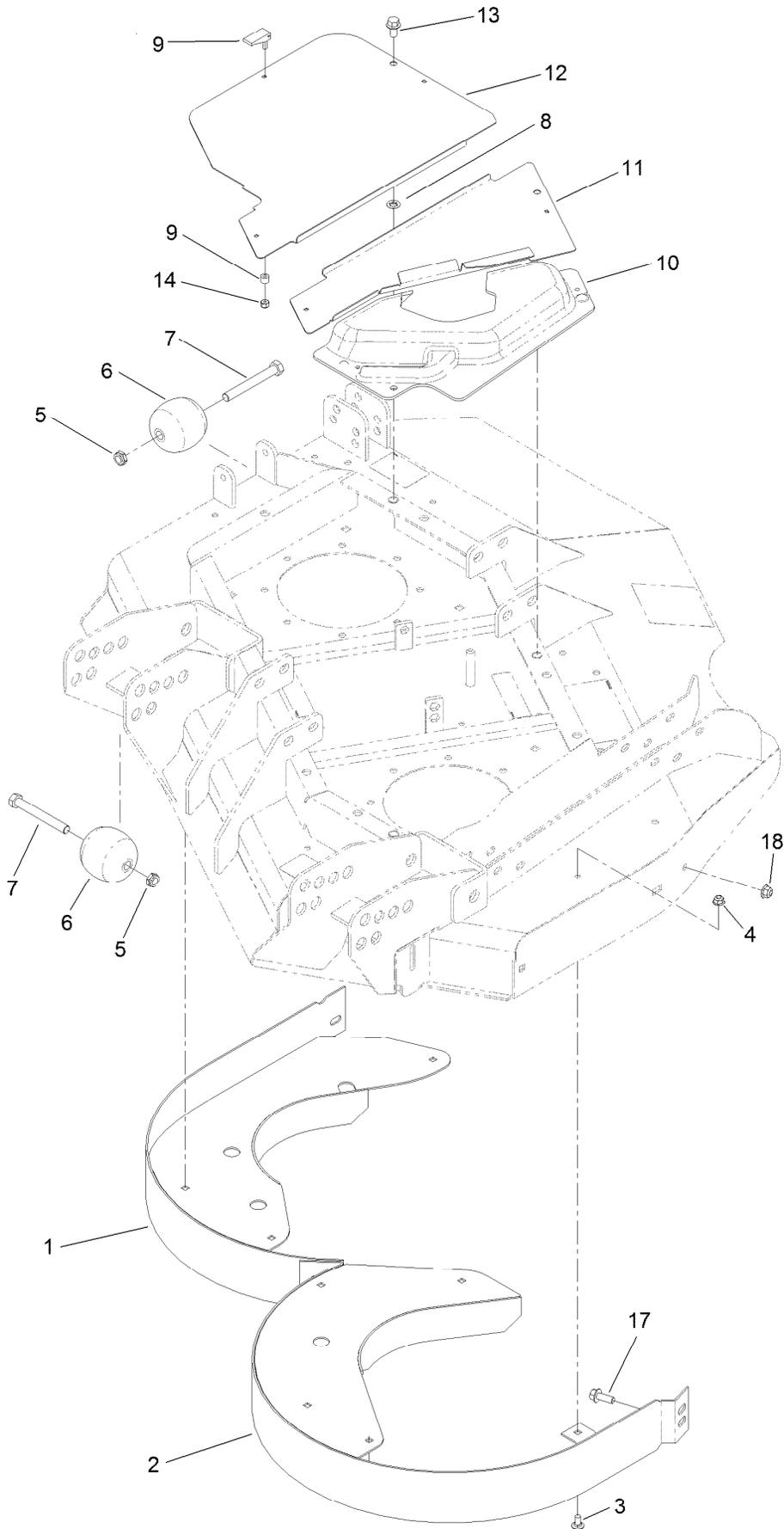

Left Deck Discharge Chamber and Cover Assembly (continued)

<i>Ref.</i>	<i>Part Number</i>	<i>Qty.</i>	<i>Description</i>	<i>Ref.</i>	<i>Part Number</i>	<i>Qty.</i>	<i>Description</i>
1	130-2682-01	1	Chamber-Outer	9	74-5950	7	Latch-Swell
2	130-2683-01	1	Chamber-Inner	10	100-5669	1	Cover-Motor, LH Deck
3	3230-18	9	Screw-CARR	11	100-5664-03	1	Plate-Cover, LH
4	104-8300	9	Nut-HF, NI	12	100-5667-03	1	Plate-Cover, LH Side
5	3296-45	2	Nut-Hex	13	3234-1	3	Screw-HHF
6	29-4820	2	Roller	14	1-804254	7	Nut-Lock, HH
7	325-17	2	Screw-HH	17	3234-42	1	Screw-HHF
8	107-3154	3	Nut-Push	18	104-8301	1	Nut-HF, NI

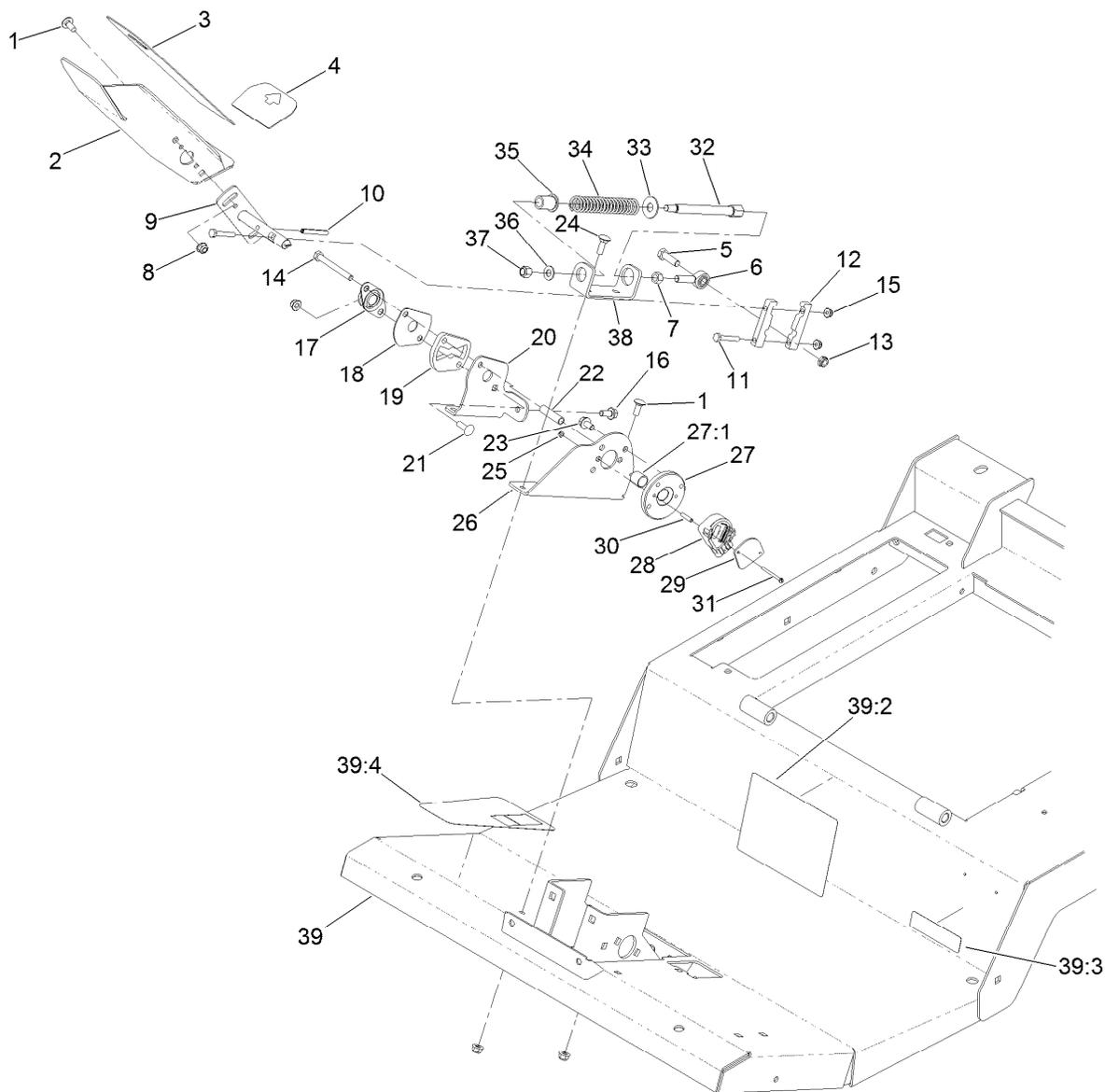

Traction Pedal and Platform Assembly

Ref.	Part Number	Qty.	Description	Ref.	Part Number	Qty.	Description
1	3230-23	5	Bolt-CARR	22	93-7960	1	Spacer
2	136-4368-01	1	Pedal-Traction	23	114-7728	2	Screw-HHF, Patch
3	93-5347	1	Abrasive-Pedal	24	3230-2	2	Bolt-CARR
4	93-5368	1	Abrasive-Pedal	25	3296-9	2	Nut-Hex
5	323-7	1	Screw-HH	26	136-4384-01	1	Bracket-Sender
6	2411-36	1	Bearing-End, Rod	27	117-5445	1	Bushing Hub ASM
7	3219-3	1	Nut-Hex	27:1	95-7497	1	Bushing-Wheel
8	104-8300	9	Nut-HF, NI	28	114-5609	1	Sensor-Position
9	131-2245	1	Shaft-Pedal, Traction	29	114-5595	1	Plate-Capture
10	32121-78	1	Pin-Roll	30	114-5608	2	Spacer-Standoff
11	321-37	2	Screw-HH	31	32105-25	2	Screw-SHH
12	117-5459	2	Block-Clamp	32	117-5446	1	Shaft-Spring
13	3296-59	1	Nut-Lock, NI	33	3256-5	1	Washer-Flat
14	322-14	1	Screw-HH	34	84-9100	1	Spring
15	104-7201	2	Nut-HF, NI	35	92-7610	1	Retainer-Spring
16	3234-47	1	Screw-HHF	36	3256-24	1	Washer-Plain
17	256-236	1	Bearing-Mount, Flange	37	3296-6	1	Nut-Lock
18	117-5455	1	Plate-Cover	38	131-2252-01	1	Bracket-Spring
19	117-5454	1	Plate-Butterfly	39	132-6251	1	Platform ASM
20	131-2250-01	1	Bracket-Butterfly	39:2	114-0846	1	Decal-Instructions, Operating
21	3230-22	1	Screw-CARR				

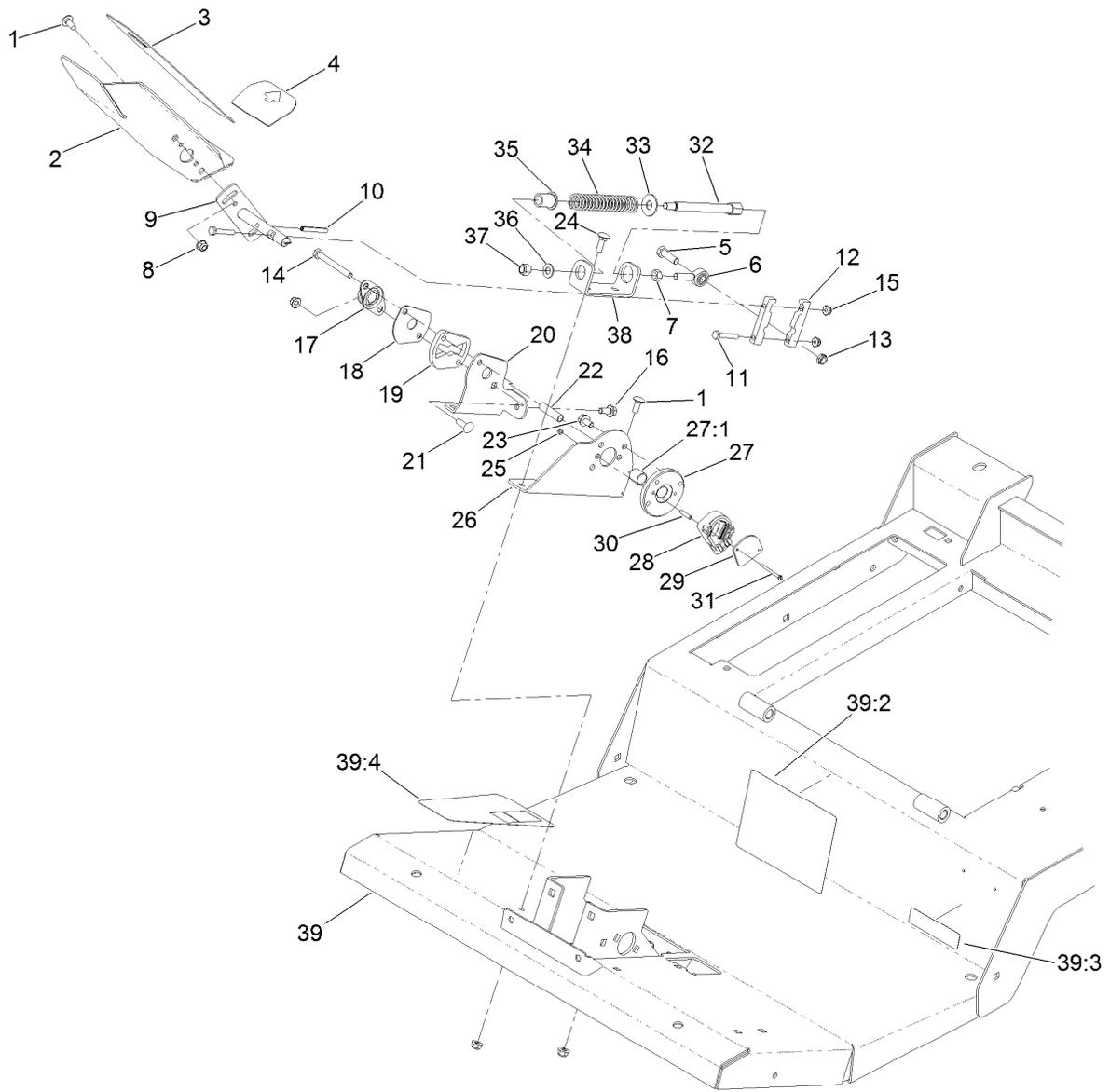

Traction Pedal and Platform Assembly (continued)

<i>Ref.</i>	<i>Part Number</i>	<i>Qty.</i>	<i>Description</i>
39:3	133-8062	1	Decal-Spark Arrestor
39:4	114-0849	1	Decal-Pedal, Traction

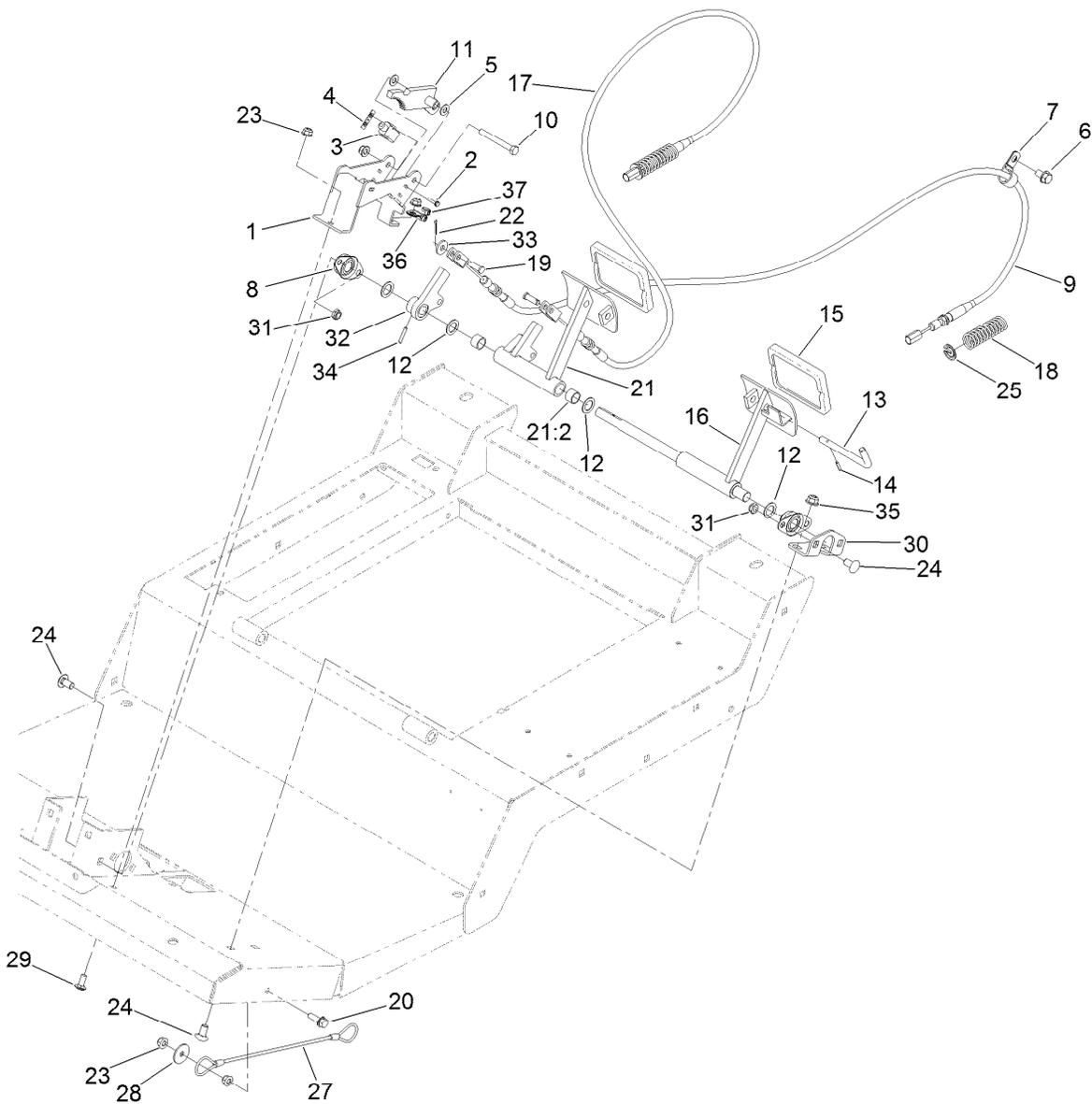

Brake Pedal Assembly

Ref.	Part Number	Qty.	Description
1	132-6259-03	1	Mount-Switch
2	117-5458	4	Screw-HHF
3	99-3410	2	Switch
4	108-9824	2	Nut-Switch
5	3256-23	2	Washer-Plain
6	32144-69	2	Screw-HWHTF
7	2412-4	2	Clamp-R
8	256-236	2	Bearing-Mount, Flange
9	120-8899	1	Cable-Brake, LH
10	322-13	1	Screw-HH
11	132-6290-03	1	Rack
12	3256-69	4	Washer-Flat
13	63-7880	1	Pin-Latch, Brake
14	32121-50	1	Pin-Spring
15	93-8742	2	Footpad-Brake
16	132-6288-01	1	Pedal-Brake, LH
17	120-8898	1	Cable-Brake, RH
18	94-3088	2	Spring-Compression
19	120-9694	2	Pin-Clevis

Ref.	Part Number	Qty.	Description
20	3234-29	1	Screw-HHF
21	132-6252	1	Pedal-Brake, RH
21:2	256-42	2	Bushing
22	3272-6	2	Pin-Cotter
23	104-8300	5	Nut-HF, NI
24	3231-21	6	Screw-CARR
25	94-3050	2	Plate-Spring
27	110-4896	1	Lanyard
28	3256-57	1	Washer-Flat
29	3230-23	2	Bolt-CARR
30	132-6247-01	1	Mount-Bearing
31	3296-59	4	Nut-Lock, NI
32	132-6229	1	Arm-Cable, Brake
33	4-2390	2	Washer-Flat
34	32121-125	1	Pin-Roll
35	104-8301	2	Nut-HF, NI
36	88-7970	1	Clip
37	1-303287	2	Tie-Cable

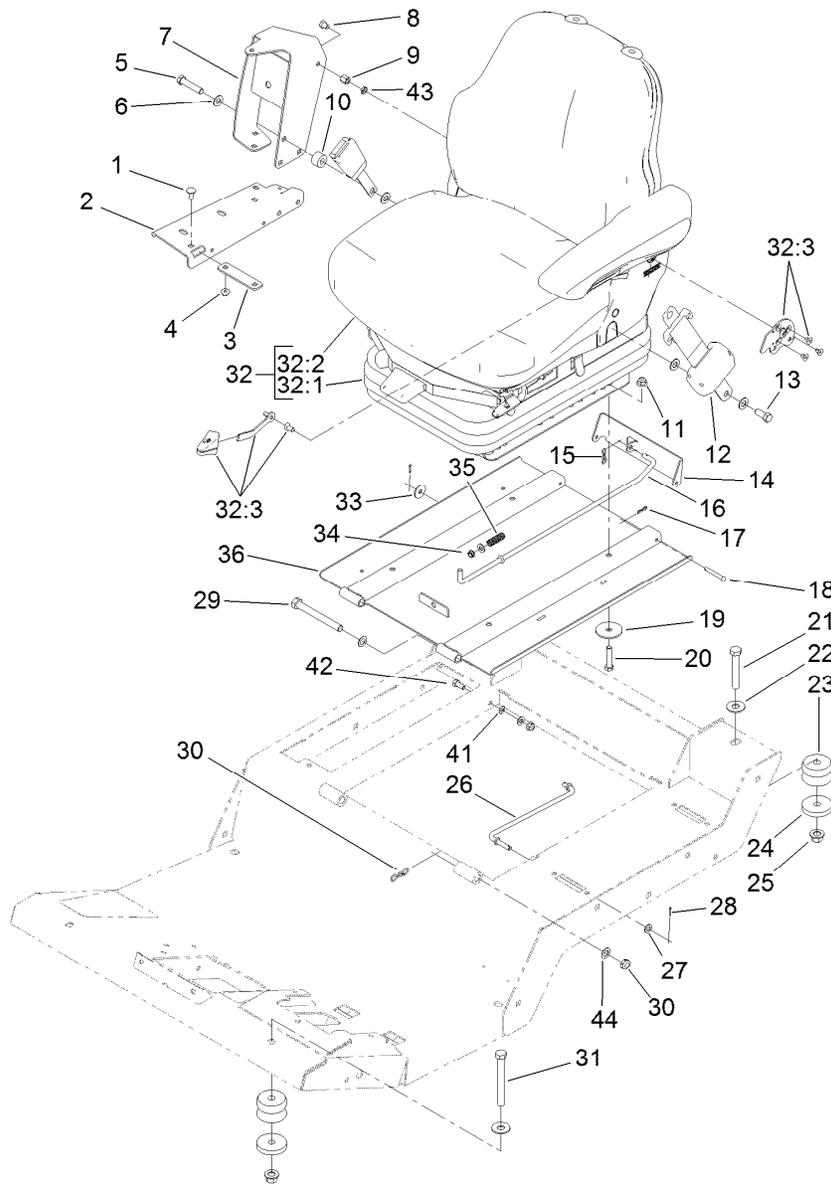

Seat Base and Seat Assembly

<i>Ref.</i>	<i>Part Number</i>	<i>Qty.</i>	<i>Description</i>	<i>Ref.</i>	<i>Part Number</i>	<i>Qty.</i>	<i>Description</i>
1	3230-23	6	Bolt-CARR	22	3256-6	4	Washer-Flat
2	119-0000-03	1	Channel-Support	23	110-5954	4	Mount-Center, Bonded
3	112-7449-03	1	Bracket-Support	24	115-5519	4	Washer-Plain
4	104-8300	7	Nut-HF, NI	25	99-5107	4	Nut-Lock
5	3212-8	1	Screw-HH	26	93-5338	1	Rod-Prop
6	3256-25	4	Washer-Flat	27	3256-23	3	Washer-Plain
7	117-4798-03	1	Arm-Support	28	3272-5	2	Pin-Cotter
8	108-8646	1	Screw-HH, Lock	29	325-18	2	Screw-HH
9	112-7405	1	Nut-Hex, Coupling	30	3296-45	2	Nut-Hex
10	17-7190	1	Spacer-Finger	31	702093	2	Screw-HH
11	104-8301	4	Nut-HF, NI	32	130-2700	1	Seat And Suspension ASM
12	110-0413	1	Seatbelt-Retractable	32:1	130-2702	1	Air Ride Seat Suspension
13	3212-4	1	Screw-HH	32:2	117-9429	1	Matrix Cloth Seat ASM
14	120-9017-03	1	Latch-Seat	32:3	132-1304	1	Backrest Adjustment Kit
15	119-1415	1	Pin-Cotter, Locking	33	3256-82	1	Washer-Flat
16	120-9018	1	Rod-Latch	34	5979	1	Bushing-Nyliner
17	119-1414	2	Pin-Cotter, Locking	35	95-1821-03	1	Spring-Compression
18	283-57	2	Pin-Clevis	36	137-5475-03	1	Plate-Seat
19	83-1040	4	Washer-Flat	41	3255-8	1	Washer-Lock
20	323-9	4	Screw-HH	42	322-3	1	Screw-HH
21	112-7264	2	Screw-HH				

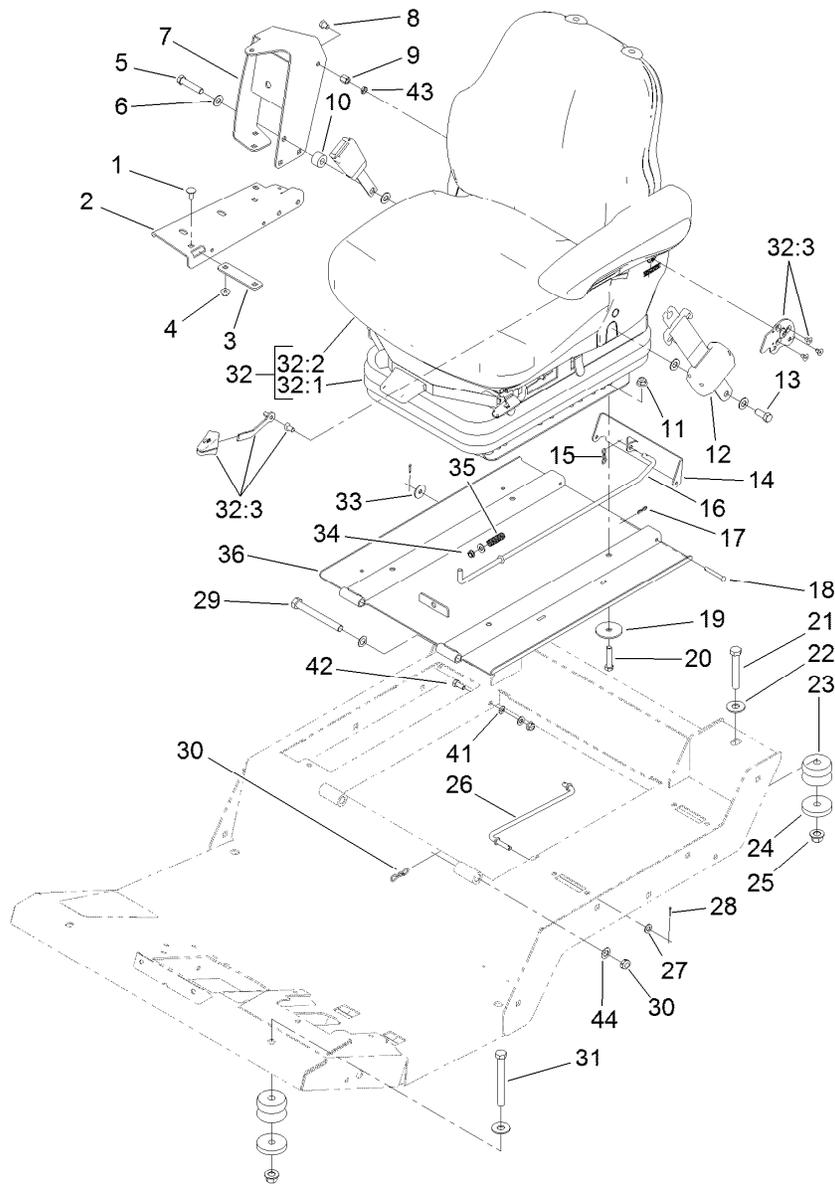

Seat Base and Seat Assembly (continued)

<i>Ref.</i>	<i>Part Number</i>	<i>Qty.</i>	<i>Description</i>
43	117-4059	1	Nut-Hex
44	36-4780	4	Washer-Plain

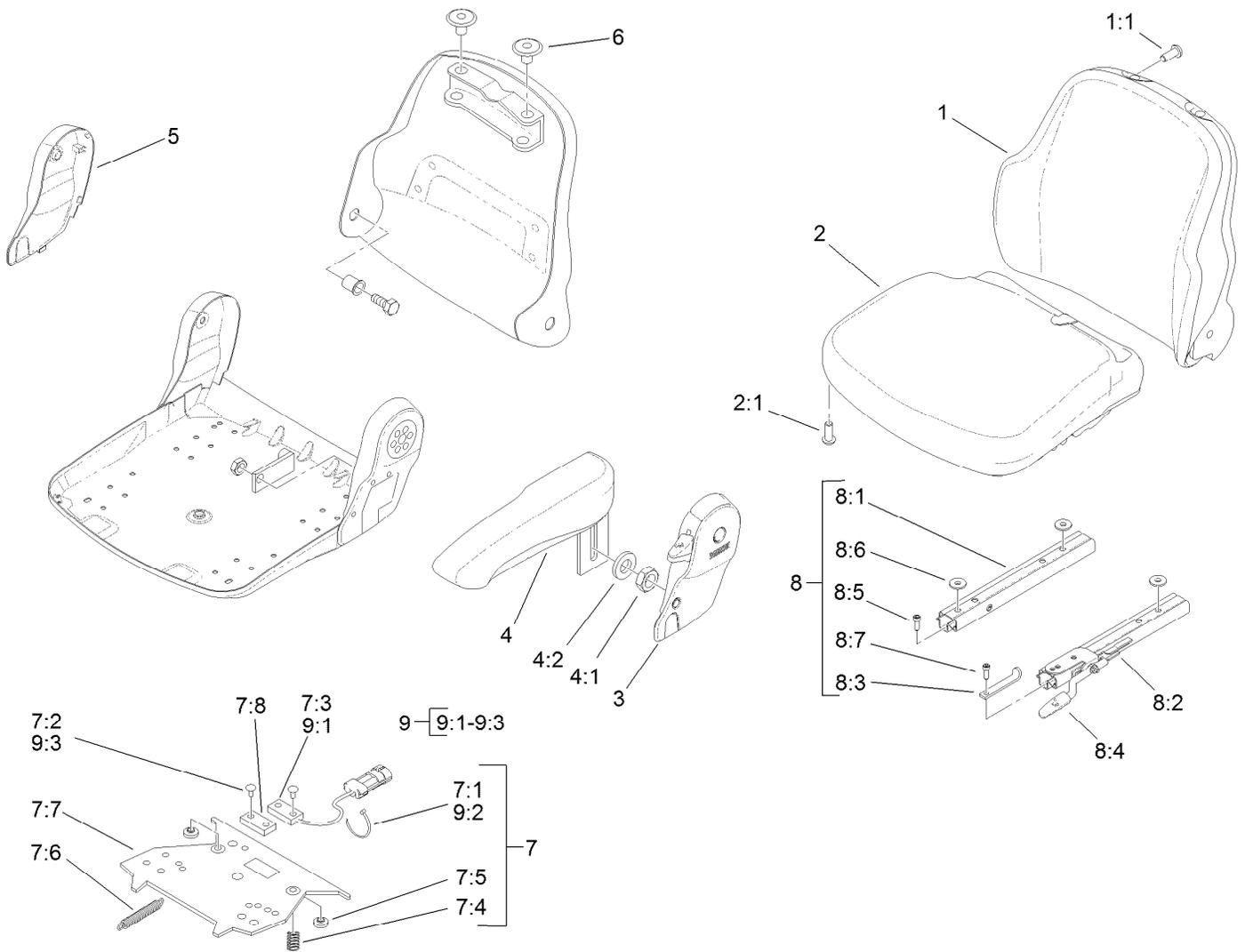

Cloth Premium Seat Assembly No. 117-9429

Ref.	Part Number	Qty.	Description	Ref.	Part Number	Qty.	Description
1	117-9415	1	Backrest Cushion ASM Matrix Cloth	7:5		2	Bumper-Pressure Plate ●
1:1	119-7742	4	Screw-Cushion	7:6		1	Spring-Extension ●
2	117-9416	1	Seat Cushion ASM Matrix Cloth	7:7		1	Plate-Mounting ●
2:1	119-7742	3	Screw-Cushion	7:8		1	Magnet ●
3	108-8018	1	Cover-Armrest	8	108-8025	1	Adjustment Rail Set
4	108-8019	1	LH Armrest ASM	8:1		1	Rail-Adjustment, RH ●
4:1	82-9650	1	Nut	8:2		1	Rail-Adjustment, LH ●
4:2	107-1198	1	Washer	8:3		1	Stop-Rail ●
5	108-8021	1	Cover-Armrest	8:4		1	Handle ●
6	108-8022	2	Cover-Black	8:5		3	Screw ●
7	108-8024	1	Switch Kit	8:6		3	Washer ●
7:1		3	Wire Tie ●	8:7		1	Screw ●
7:2		4	Rivet ●	9	110-6189	1	Switch Kit
7:3		1	Sensor-Seat Switch ●	9:1		1	Switch ●
7:4		2	Spring-Compression ●	9:2		3	Wire Tie ●
				9:3		2	Rivet ●

● Not serviced separately

Seat Suspension Assembly No. 130-2702

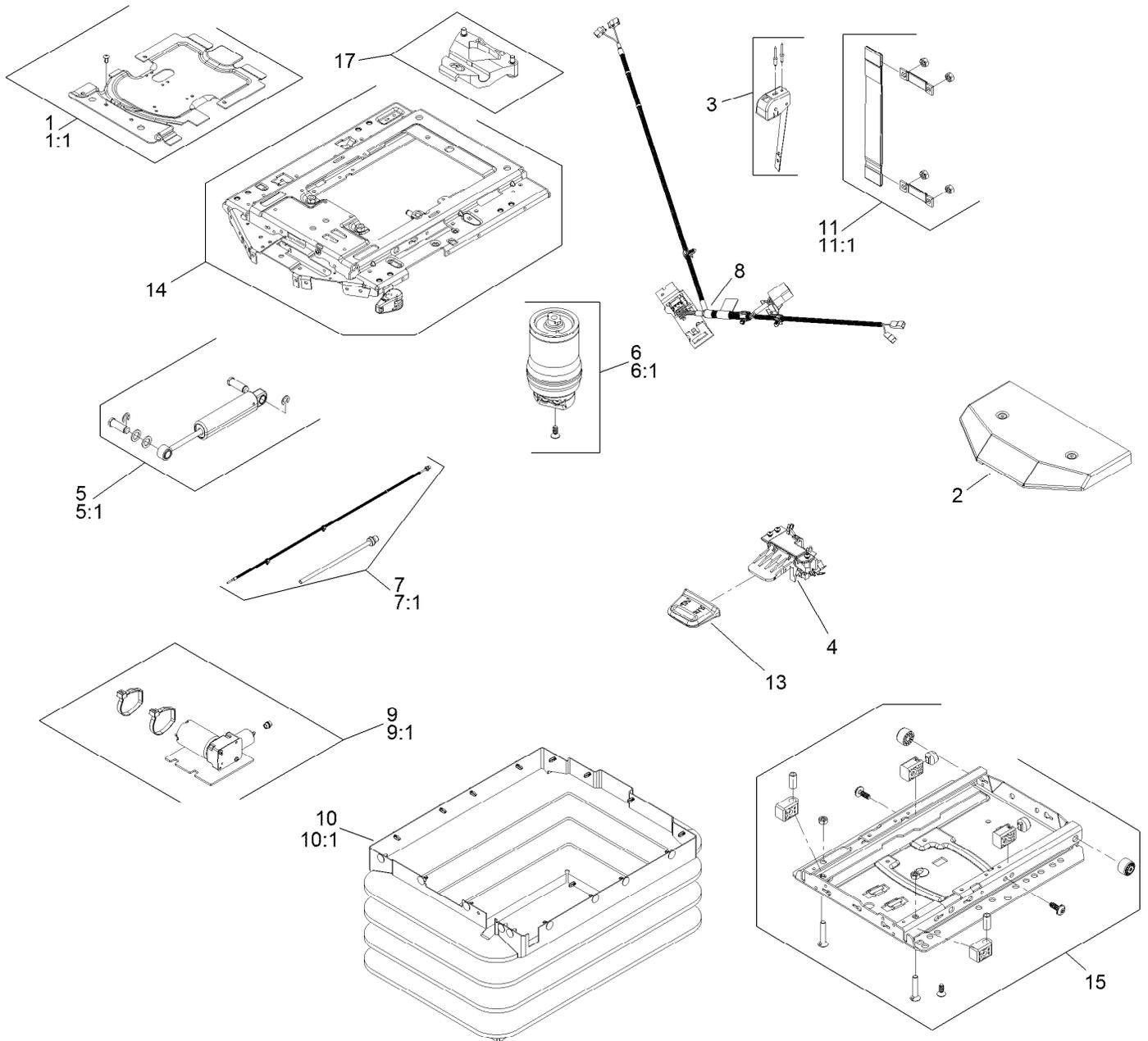

Seat Suspension Assembly No. 130-2702 (continued)

<i>Ref.</i>	<i>Part Number</i>	<i>Qty.</i>	<i>Description</i>	<i>Ref.</i>	<i>Part Number</i>	<i>Qty.</i>	<i>Description</i>
1	130-2709	1	Cover ASM	9	130-2719	1	Compressor
1:1	130-2710	1	Cover Kit	9:1	130-2720	1	Compressor Kit
2	108-8027	1	Cover	10	130-2721	1	Bellows ASM
3	130-2711	1	Control-Level	10:1	130-2722	1	Bellows Kit
4	108-8029	1	Valve-Control, Air	11	130-2723	1	Tether
5	130-2712	1	Shock Absorber ASM	11:1	130-2724	1	Tether Kit
5:1	130-2713	1	Shock Absorber Kit	12	130-2725	1	Wear Parts Kit ●
6	130-2714	1	Air Spring ASM	13	130-2726	1	Handle
6:1	130-2715	1	Air Spring Kit	14	130-2727	1	Upper Suspension Kit
7	130-2716	1	Air Tube ASM	15	130-2728	1	Lower Suspension Kit
7:1	130-2717	1	Air Tube Kit	16	130-2729	1	Adjuster Mounting Kit ●
8	130-2718	1	Harness-Wire	17	130-2730	1	Limiters-Thrust

● Not illustrated

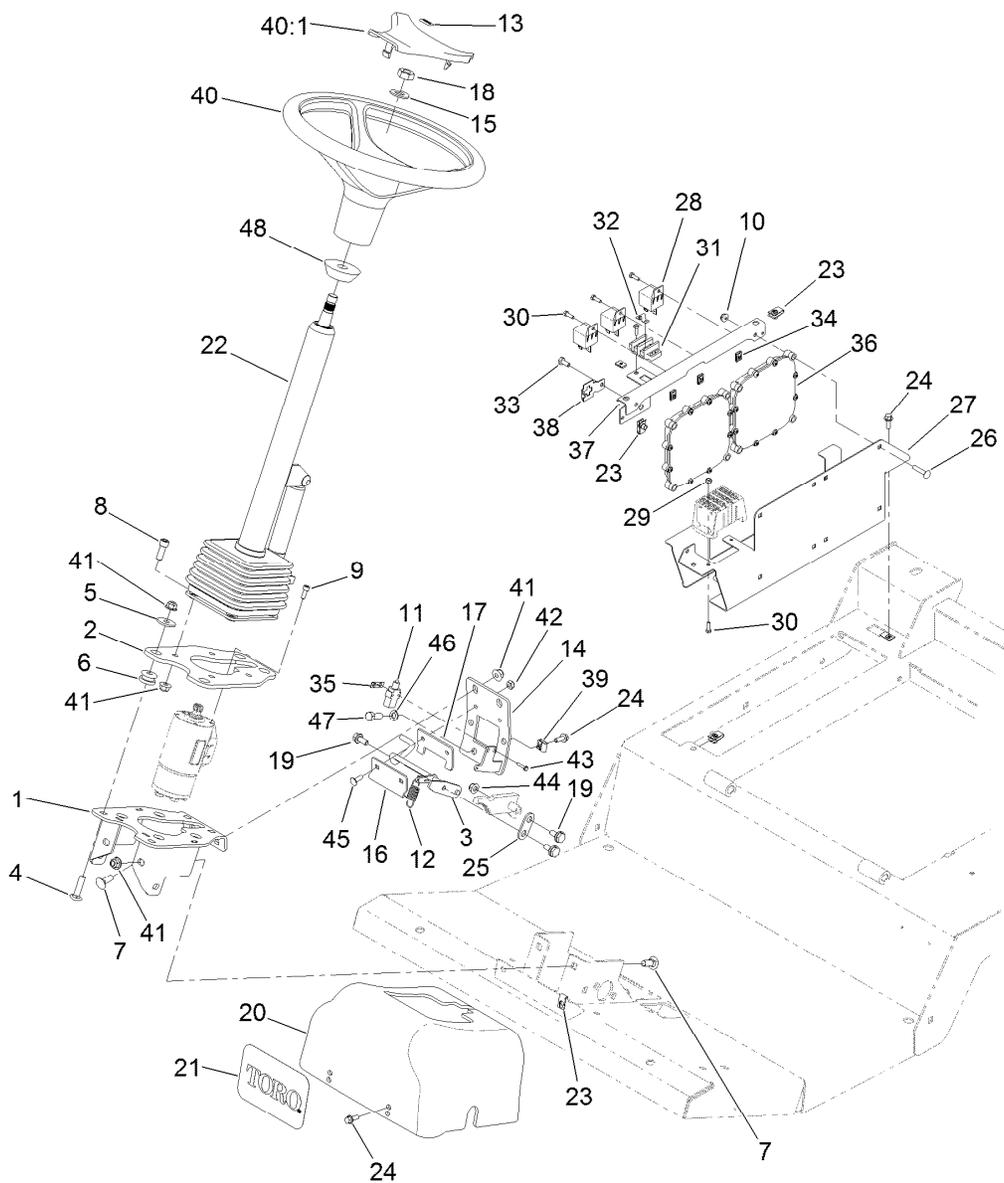

Steering and Controller Assembly

Ref.	Part Number	Qty.	Description	Ref.	Part Number	Qty.	Description
1	137-5590-03	1	Mount	22	132-6230	1	Steering Tilt Column ASM
2	137-5588-03	1	Plate-Mount, Column	23	107069	7	Clip
3	132-6285	1	Rod-Brake	24	3234-4	6	Screw-HHF
4	3231-26	4	Screw-CARR	25	137-5548	1	Link-Brake
5	63-8410	4	Washer	26	3229-3	8	Screw-CARR
6	63-9750	4	Mount	27	120-4093-03	1	Mount-Power
7	3231-2	6	Bolt-CARR	28	99-7435	3	Relay
8	3274-7	4	Screw-HSH	29	3296-12	2	Nut-Lock, NI
9	105-2409	4	Screw-HSH	30	3290-134	7	Screw
10	104-7201	8	Nut-HF, NI	31	42862	1	Block-Terminal, Ground
11	99-3410	1	Switch	32	42863	1	Strip-Jumper
12	136-7153	1	Spring-Extension	33	321-3	1	Screw-HH
13	98-1459	1	Decal	34	107-1013	5	Nut-Speed
14	132-6225-03	1	Support-Rear	35	108-9824	1	Nut-Switch
15	3256-27	1	Washer-Flat	36	114-3321	2	Controller-Tec
16	132-6283	1	Plate-Brake	37	120-4127-03	1	Mount-Relay
17	132-6284	1	Plate-Brake	38	114-5502	1	Clip-Fuse
18	3296-33	1	Nut-Lock, NI	39	609900	2	Nut-Speed
19	37-8771	2	Bolt-Shoulder, HF	40	98-1471	1	Wheel-Steering
20	132-6244	1	Cover-Steering	40:1	98-1468	1	Cover-Wheel, Steering
21	105-1217	1	Decal	41	104-8301	14	Nut-HF, NI

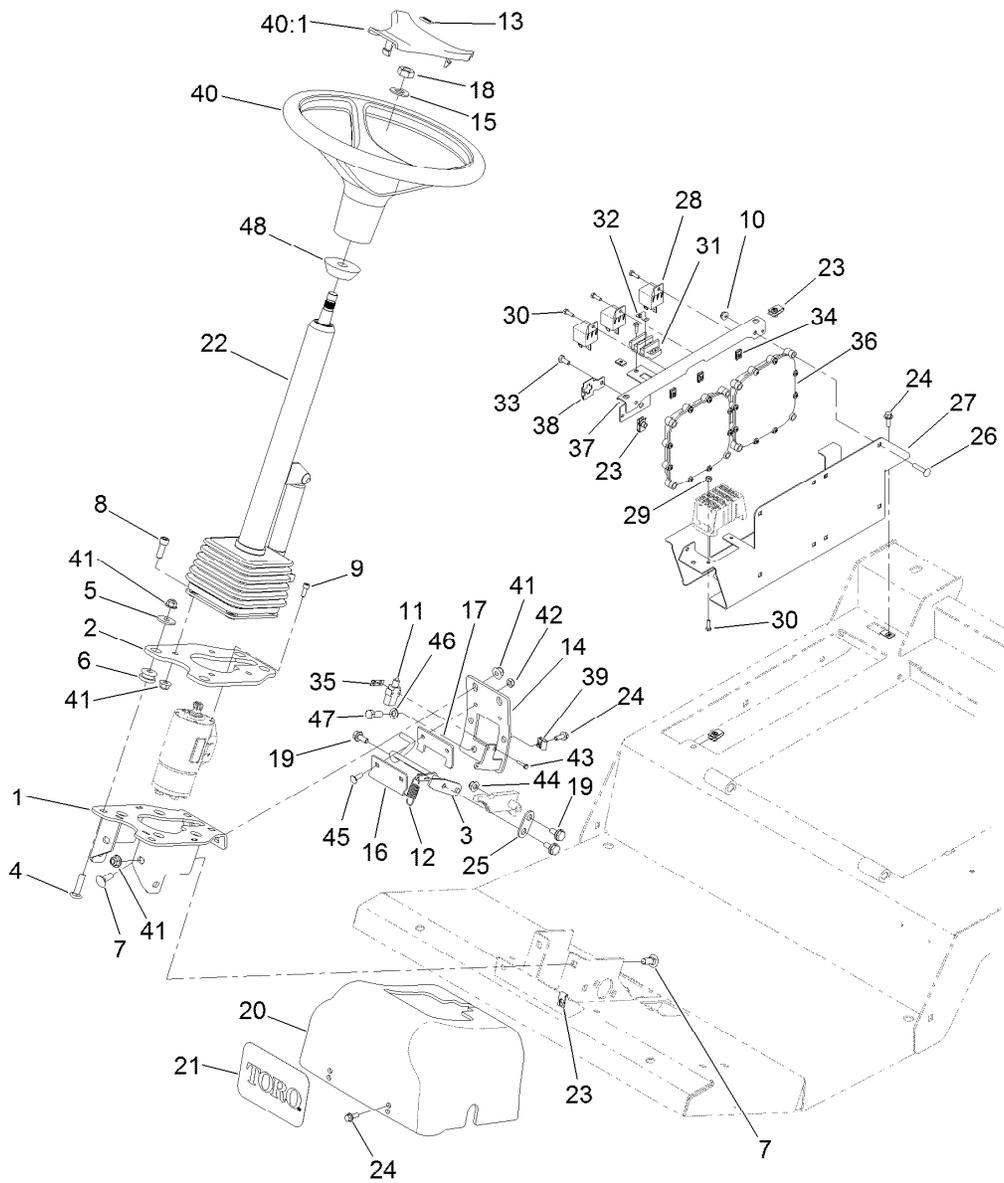

Steering and Controller Assembly (continued)

<i>Ref.</i>	<i>Part Number</i>	<i>Qty.</i>	<i>Description</i>
42	3296-16	2	Nut-Lock, NI
43	117-5458	2	Screw-HHF
44	104-8300	2	Nut-HF, NI
45	1-807512	2	Bolt-CARR

<i>Ref.</i>	<i>Part Number</i>	<i>Qty.</i>	<i>Description</i>
46	3253-21	2	Washer-Lock
47	323-6	2	Screw-HH
48	93-5429	1	Collar-Foam

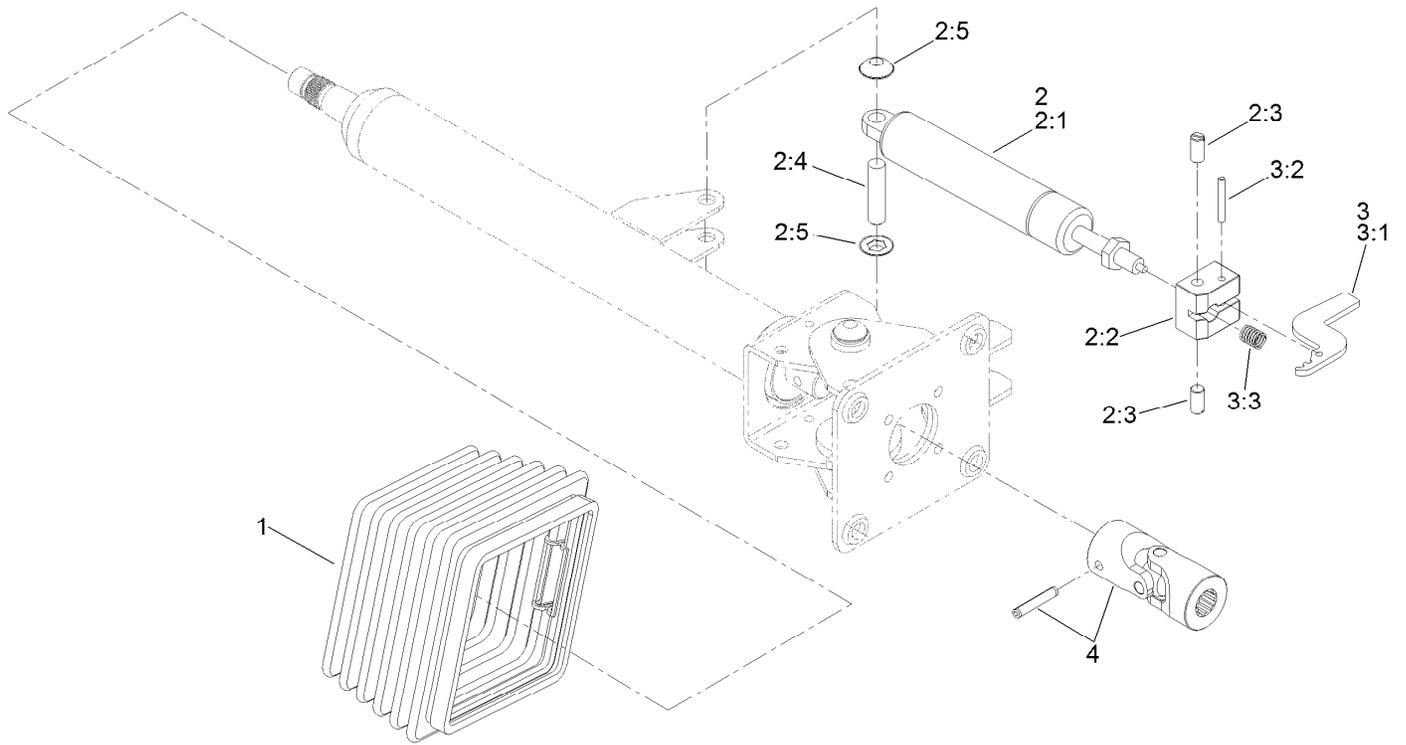

Steering Column Assembly No. 132-6230

Ref.	Part Number	Qty.	Description
1	110-6462	1	Bellows-Rubber
2	110-6463	1	Cylinder Service Kit
2:1		1	Cylinder-Gas ●
2:2		1	Block-Pedal ●
2:3		2	Bolt ●
2:4		1	Pin ●
2:5		2	Washer-Lock ●
3	136-4385	1	Pedal Service Kit
3:1		1	Pedal ●
3:2		1	Pin ●
3:3		1	Spring ●
4	120-6256	1	Universal Joint Kit

● Not serviced separately

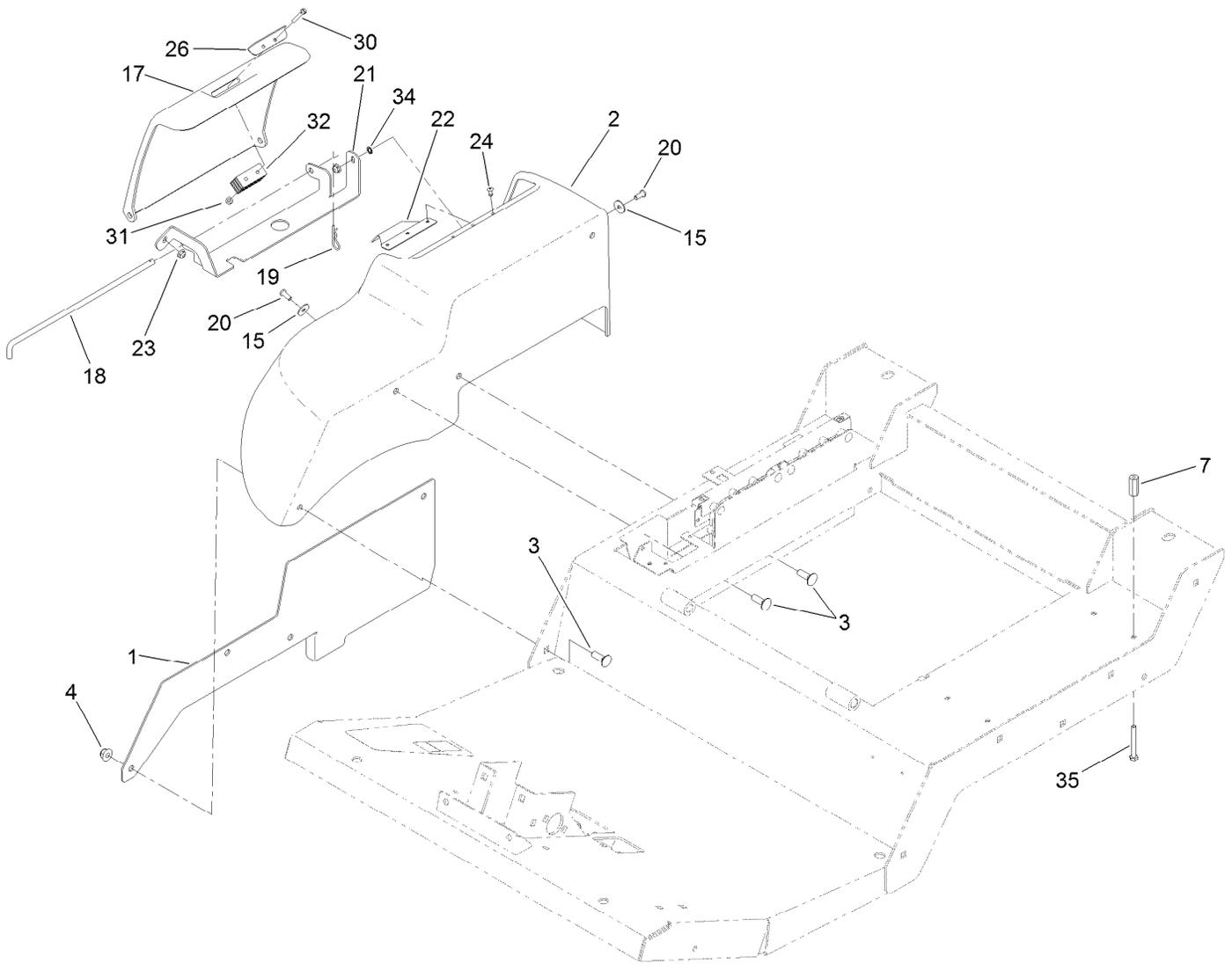

RH Fender Assembly

<i>Ref.</i>	<i>Part Number</i>	<i>Qty.</i>	<i>Description</i>	<i>Ref.</i>	<i>Part Number</i>	<i>Qty.</i>	<i>Description</i>
1	121-1579-03	1	Plate-Fender, RH	21	121-1586-03	1	Mount-Cover
2	120-4113	1	Fender-RH	22	127-3706	1	Plate-Cover
3	3231-25	4	Bolt-CARR	23	104-7201	2	Nut-HF, NI
4	104-8301	4	Nut-HF, NI	24	3269-23	3	Rivet-Pop
7	136-4358	4	Nut-Coupling	26	127-3705	1	Plate-Cover
15	87-6630	2	Washer-Plain	30	32105-1	2	Screw-SHH
17	120-4115	1	Cover-Battery	31	3296-2	2	Nut-Lock, NI
18	121-1588	1	Rod-Hinge	32	69-6260	1	Magnet
19	3290-467	1	Pin-Hair	34	3255-7	1	Washer-Lock/EXT
20	3274-31	2	Screw-HSBH	35	100-5858	4	Screw-HH

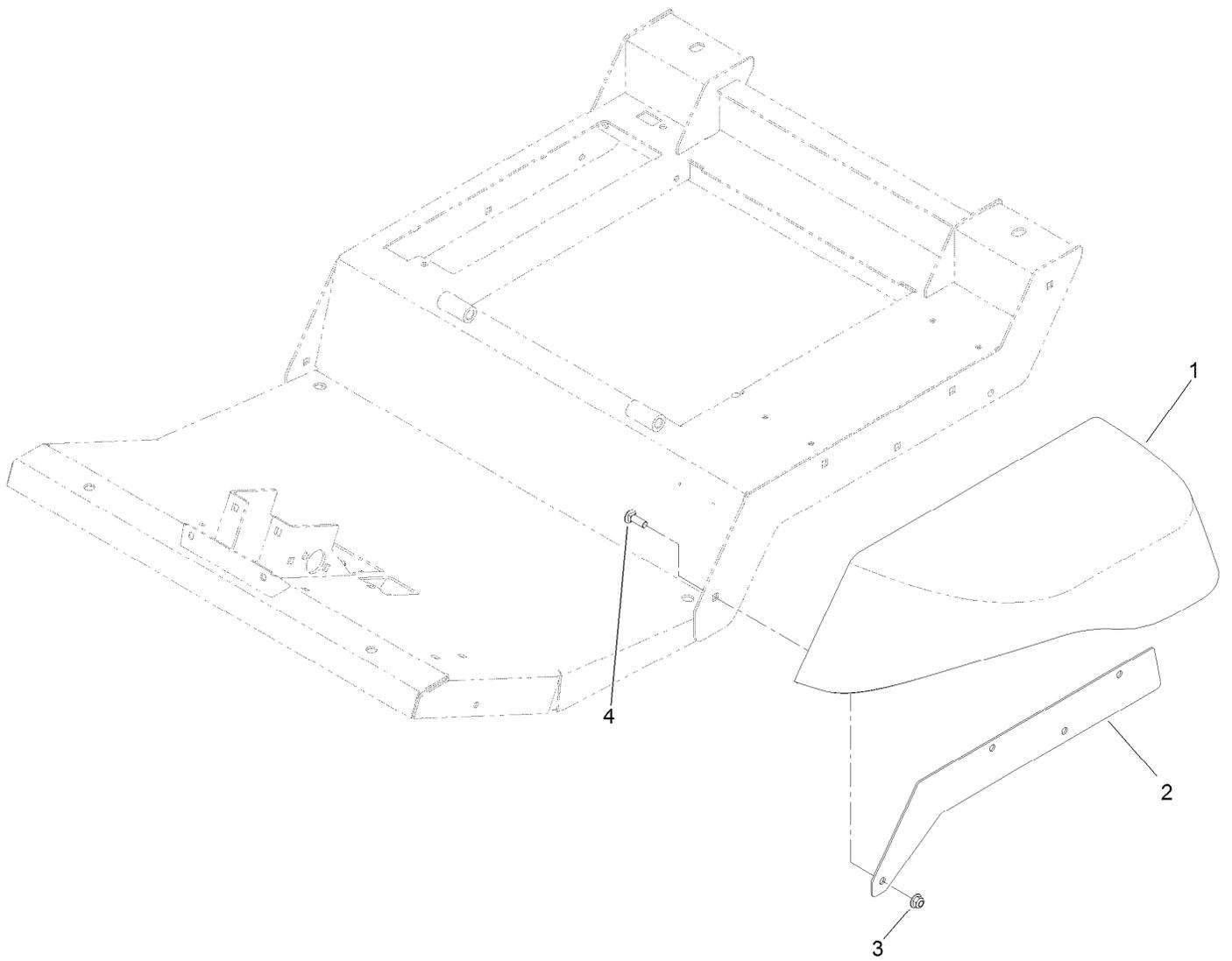

Fender Assembly

<i>Ref.</i>	<i>Part Number</i>	<i>Qty.</i>	<i>Description</i>
1	120-4114	1	Fender-LH
2	121-1580-03	1	Plate-Fender, LH
3	104-8301	4	Nut-HF, NI
4	3231-25	4	Bolt-CARR

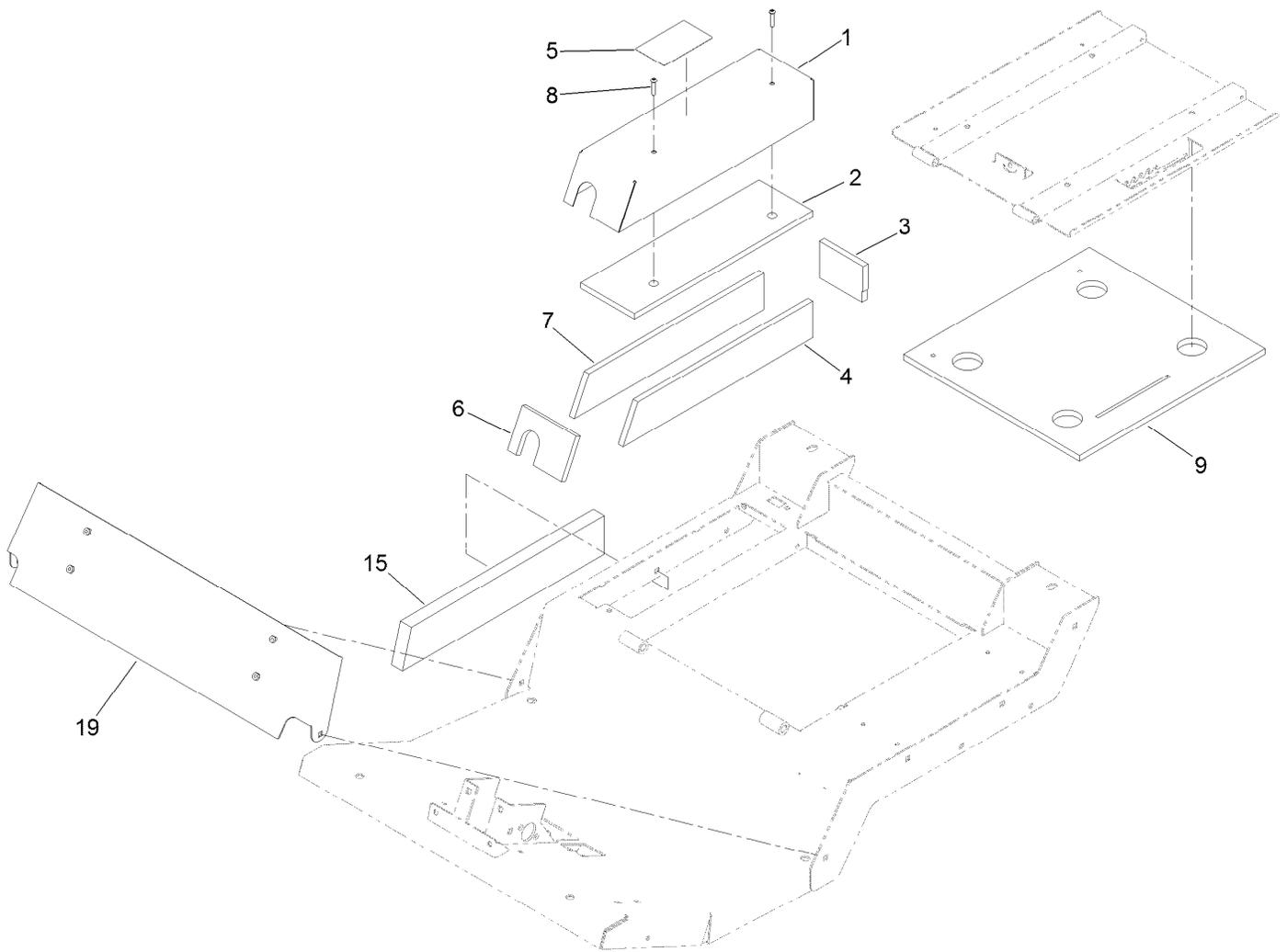

Acoustic Foam, Panel and Cover Assembly

<i>Ref.</i>	<i>Part Number</i>	<i>Qty.</i>	<i>Description</i>
1	136-4386-03	1	Cover-Controller
2	136-4378	1	Foam-Cover, Top
3	136-4375	1	Foam-Cover, Rear
4	136-4376	1	Foam-Cover, Left
5	136-4436	1	Decal-Fuses
6	136-4374	1	Foam-Cover, Front
7	136-4377	1	Foam-Cover, Right
8	120-0834	2	Screw-HSBH
9	127-3696	1	Foam-Seat
15	127-3708	1	Foam-Right
19	136-4373-01	1	Plate-Foot

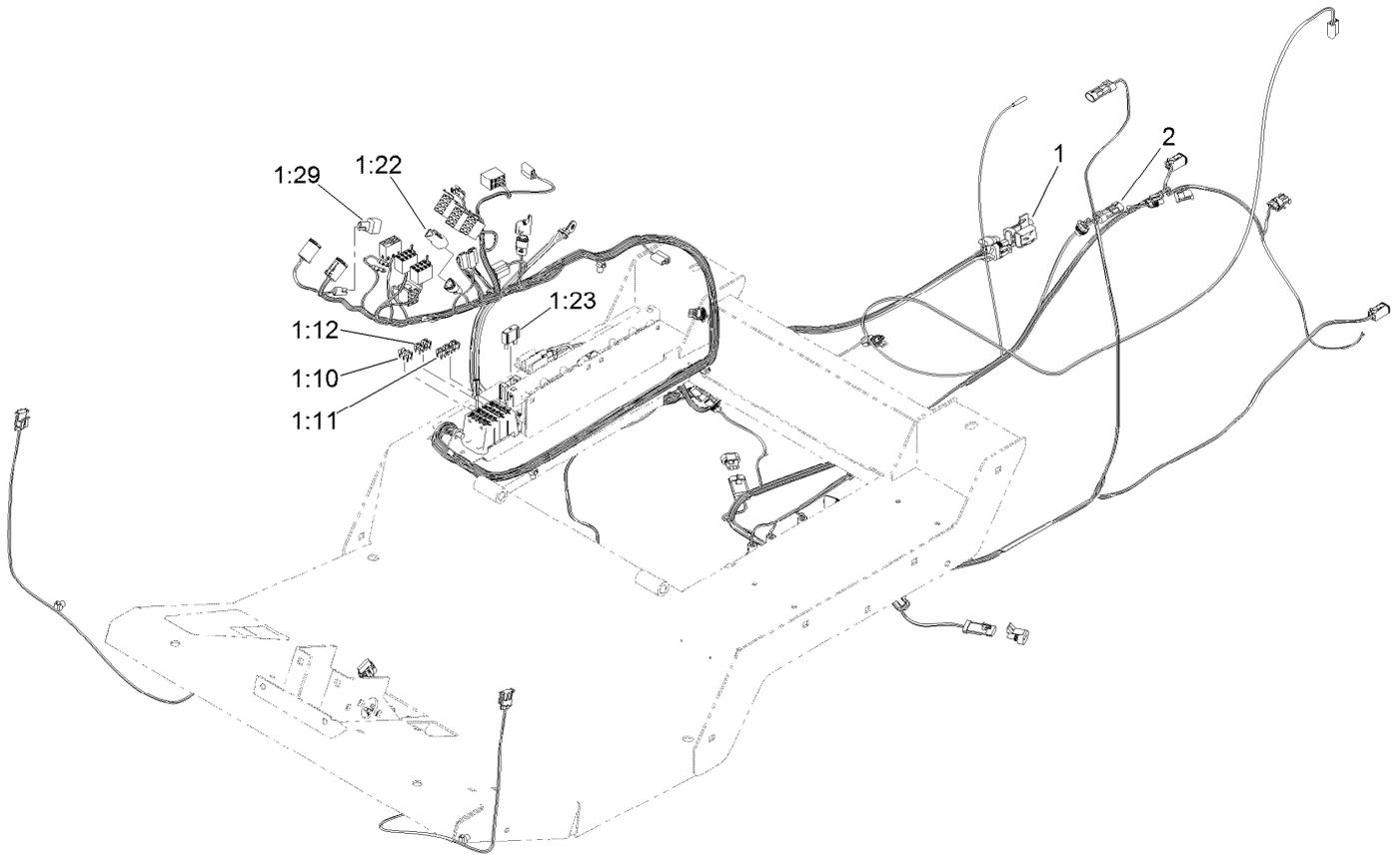

Platform Wire Harness and Fuse Assembly

<i>Ref.</i>	<i>Part Number</i>	<i>Qty.</i>	<i>Description</i>
1	122-1530	1	Harness-Wire, Platform
1:10	121-8861	3	Fuse-Mini Blade, 2 Amp
1:11	121-8865	6	Fuse-Mini Blade, 7.5 Amp
1:12	121-8866	4	Fuse-Mini Blade, 10 Amp
1:22	32180-043	1	Resistor-120 Ohm
1:23	114-3342	1	Fuse-Maxi, 60 Amp
1:29	104-4022	1	Resistor-75 Ohm
2	122-0353	1	Harness-Wire

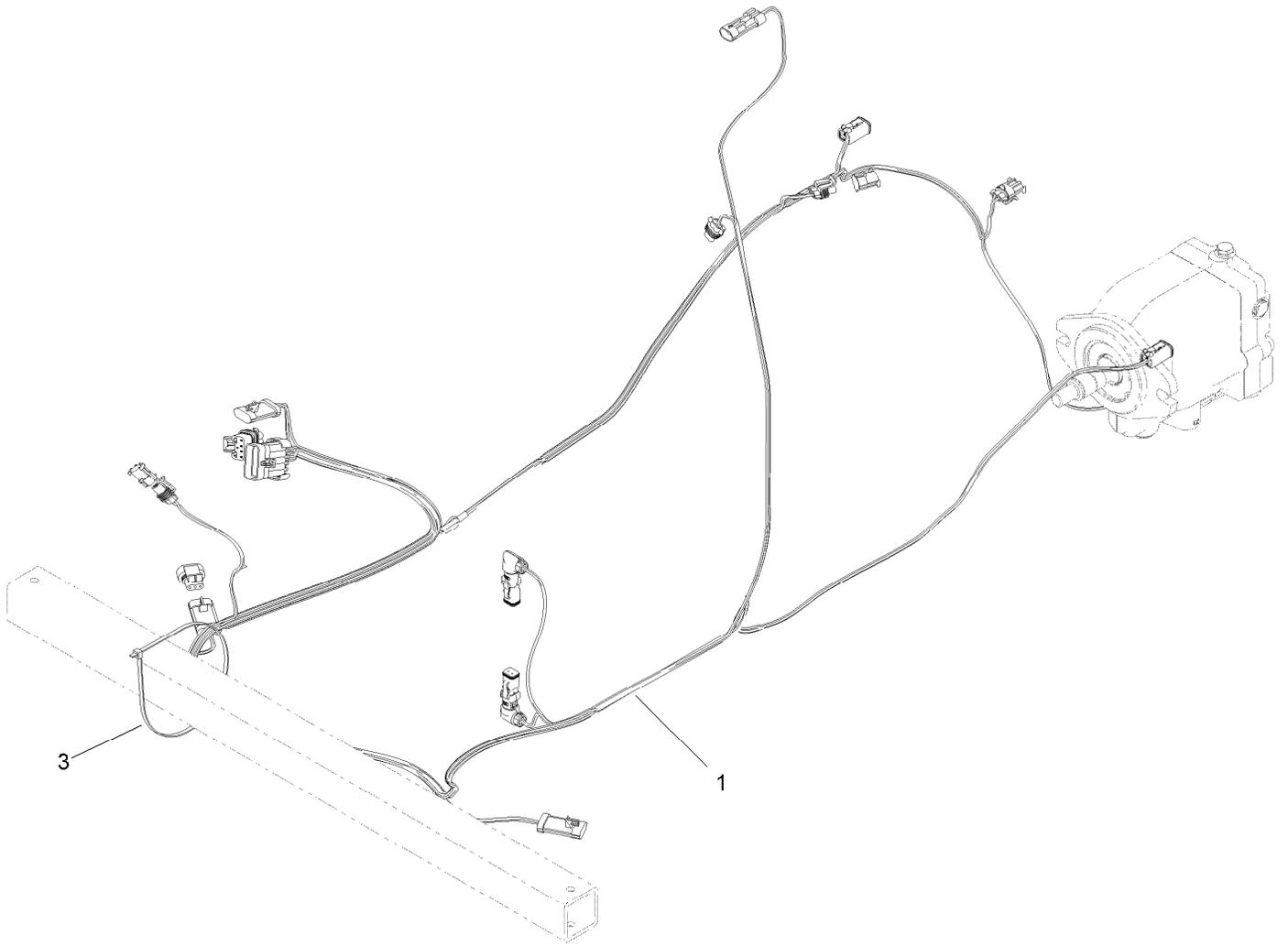

Rear Wire Harness Assembly

<i>Ref.</i>	<i>Part Number</i>	<i>Qty.</i>	<i>Description</i>
1	122-0974	1	Harness-Wire, Rear
3	3290-379	1	Tie-Cable

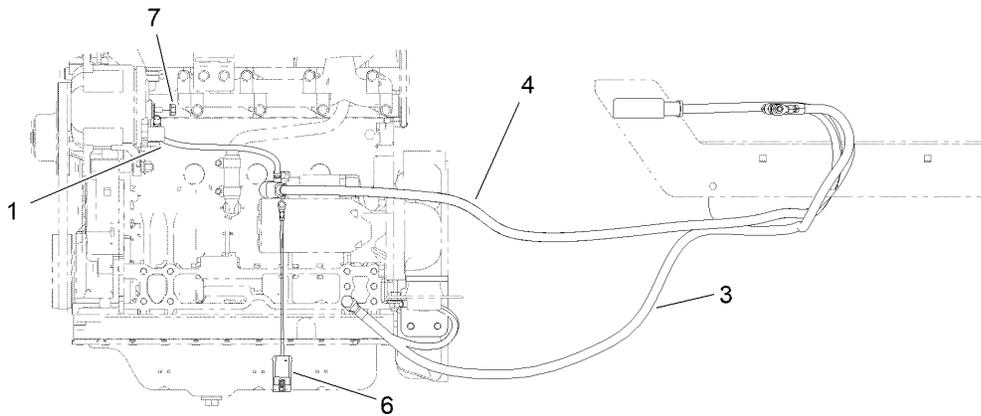
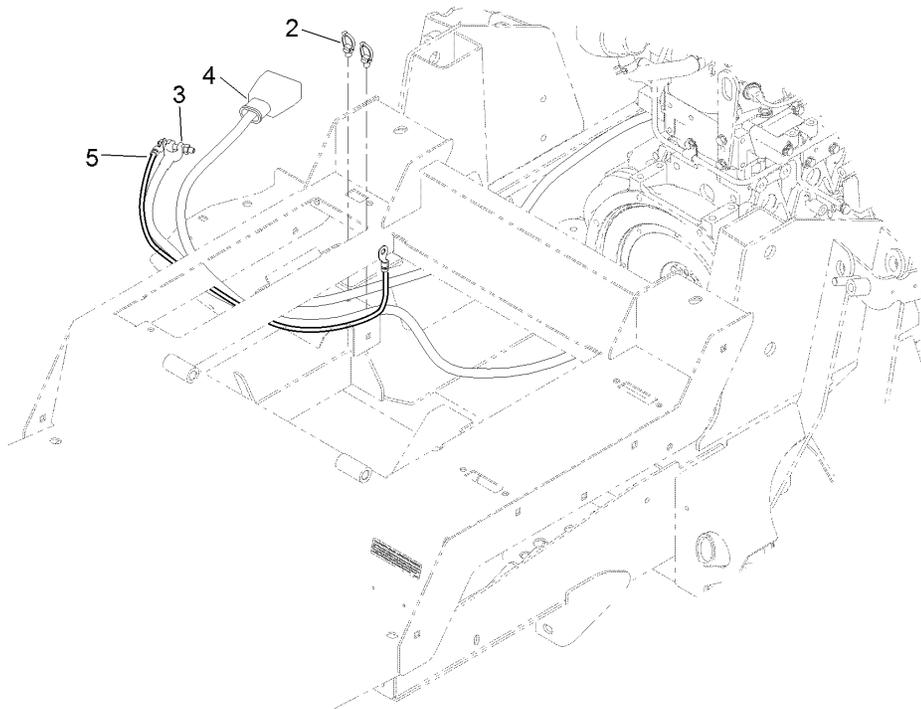

Battery Cable and Ground Assembly

<i>Ref.</i>	<i>Part Number</i>	<i>Qty.</i>	<i>Description</i>
1	122-0071	1	Cable-Battery, Positive
2	32180-030	2	Clip-Tie
3	121-8898	1	Cable-Battery, Negative
4	121-8897	1	Cable-Battery, Positive
5	54-3094	1	Cable
6	108-9470	1	Harness-Wire, Fusible Link
7	33004-00	2	Nut-HF

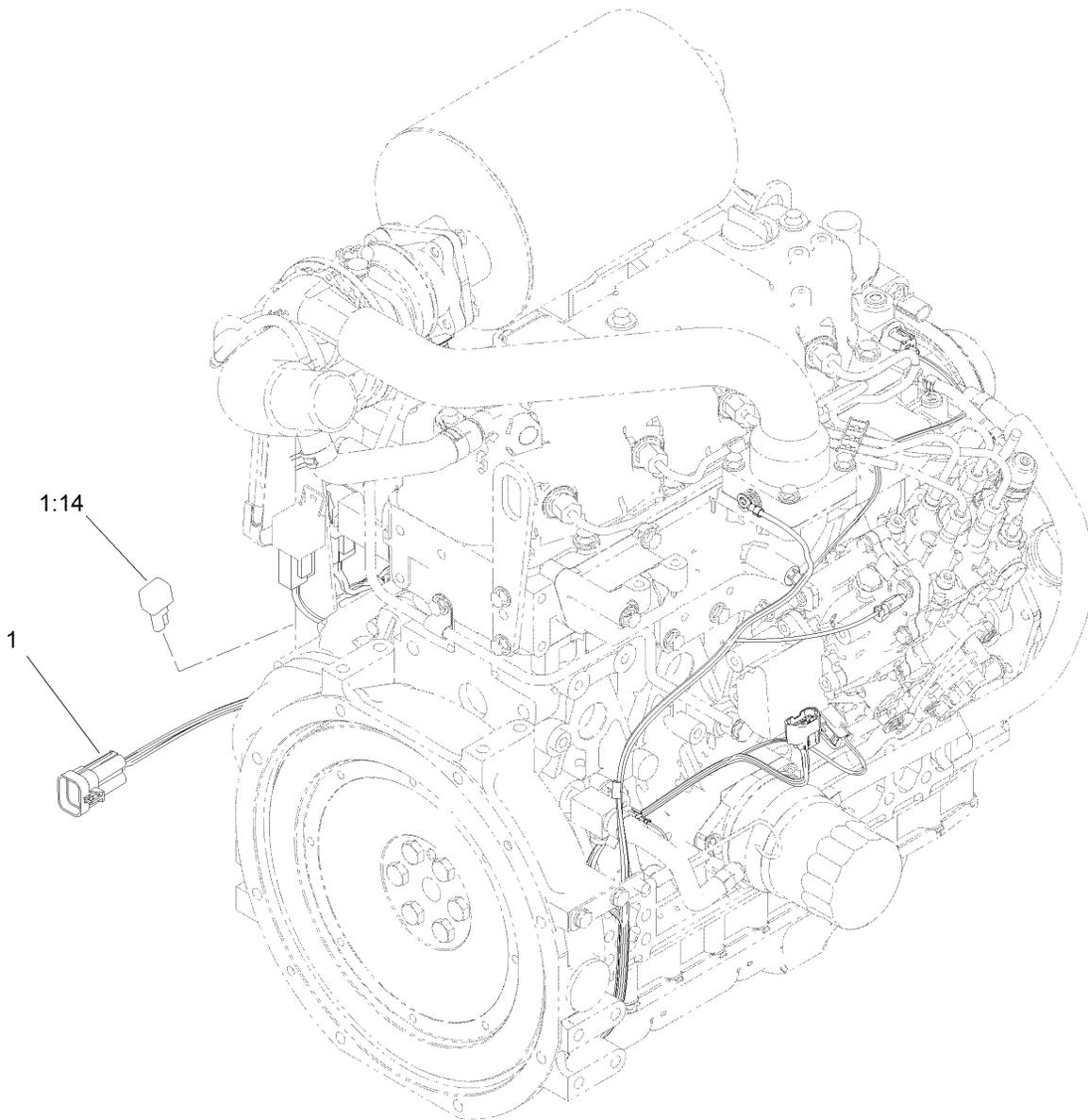

Engine Harness Assembly

<i>Ref.</i>	<i>Part Number</i>	<i>Qty.</i>	<i>Description</i>
1	119-4351	1	Harness-Wire, Engine
1:14	100-4918	1	Diode

Piston Pump and Gear Pump Assembly

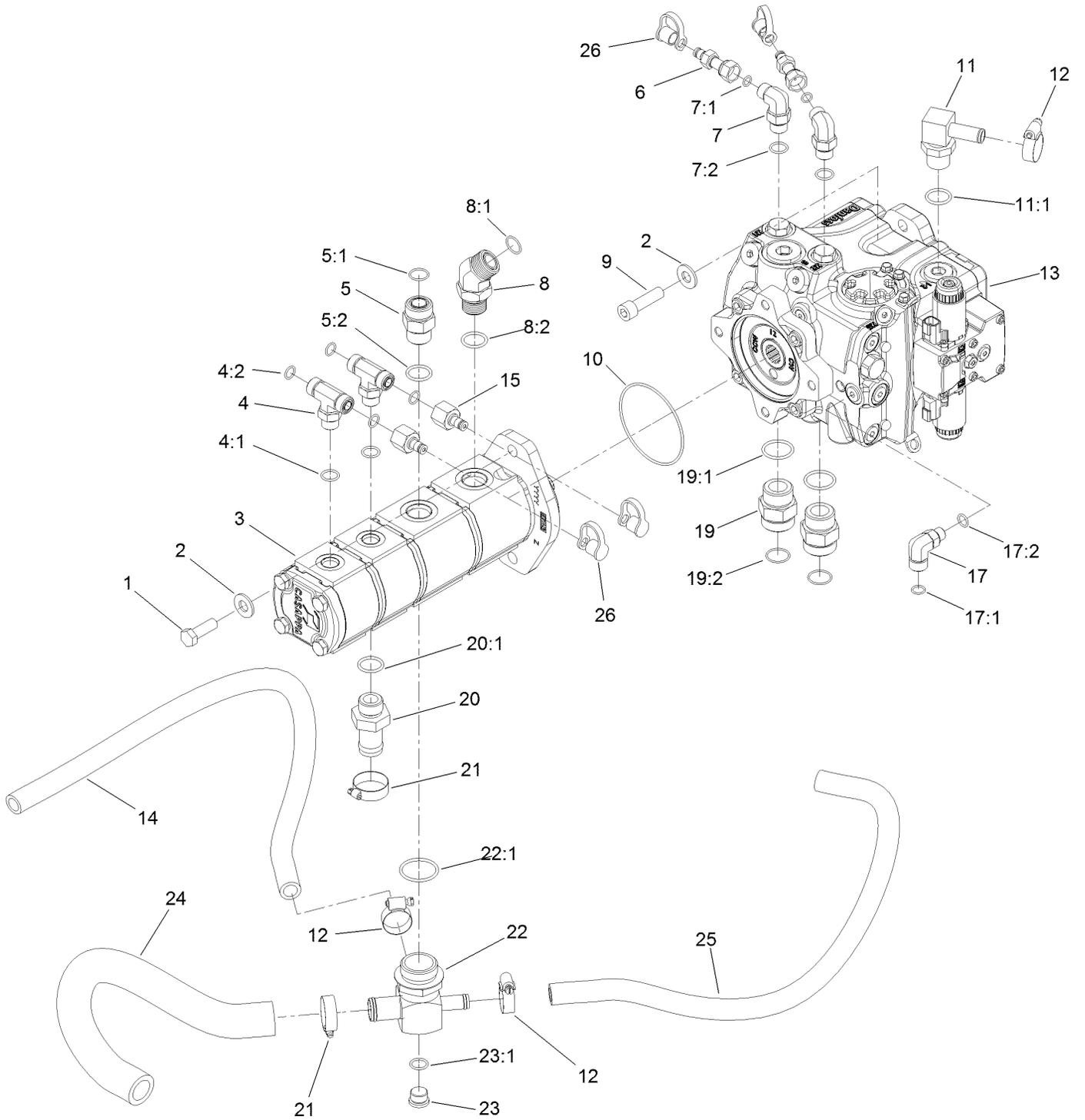

Piston Pump and Gear Pump Assembly (continued)

<i>Ref.</i>	<i>Part Number</i>	<i>Qty.</i>	<i>Description</i>	<i>Ref.</i>	<i>Part Number</i>	<i>Qty.</i>	<i>Description</i>
1	121-1525	2	Screw-HH	12	2412-129	3	Clamp-Hose
2	137-5550	4	Washer-Thrust	13	132-6100	1	Pump-Piston
3	120-8904	1	4-Section Gear Pump ASM	14	121-1647	1	Hose-HYD
4	340-157	2	Fitting-HYD, Tee	15	100-5616	2	Fitting
4:1	237-79	1	O-Ring	17	340-99	1	Fitting-HYD, 90 DEG
4:2	237-30	2	O-Ring	17:1	237-30	1	O-Ring
5	340-9	1	Fitting-STR	17:2	237-42	1	O-Ring
5:1	237-58	1	O-Ring	19	104-3797	2	Fitting-Straight
5:2	237-81	1	O-Ring	19:1	237-146	1	O-Ring
6	86-5480	2	Nipple-Test	19:2	340-65	1	O-Ring
7	340-18	2	Fitting-HYD, 90 DEG	20	99-3017	1	Fitting
7:1	237-79	1	O-Ring	20:1	237-81	1	O-Ring
7:2	237-22	1	O-Ring	21	2412-34	2	Clamp-Hose
8	100-5530	1	Fitting-45 DEG	22	121-1682	1	Fitting-Tee
8:1	237-58	1	O-Ring	22:1	237-101	1	O-Ring
8:2	237-81	1	O-Ring	23	353-988	1	Plug-Hex
9	131-0661	2	Screw-HSH	23:1	237-79	1	O-Ring
10	107-9447	1	O-Ring	24	120-8815	1	Hose-Suction
11	136-4439	1	Fitting-HYD, 90	25	120-9050	1	Hose-HYD
11:1	237-81	1	O-Ring	26	354-79	4	Cap-Dust

4-Section Gear Pump Assembly No. 120-8904

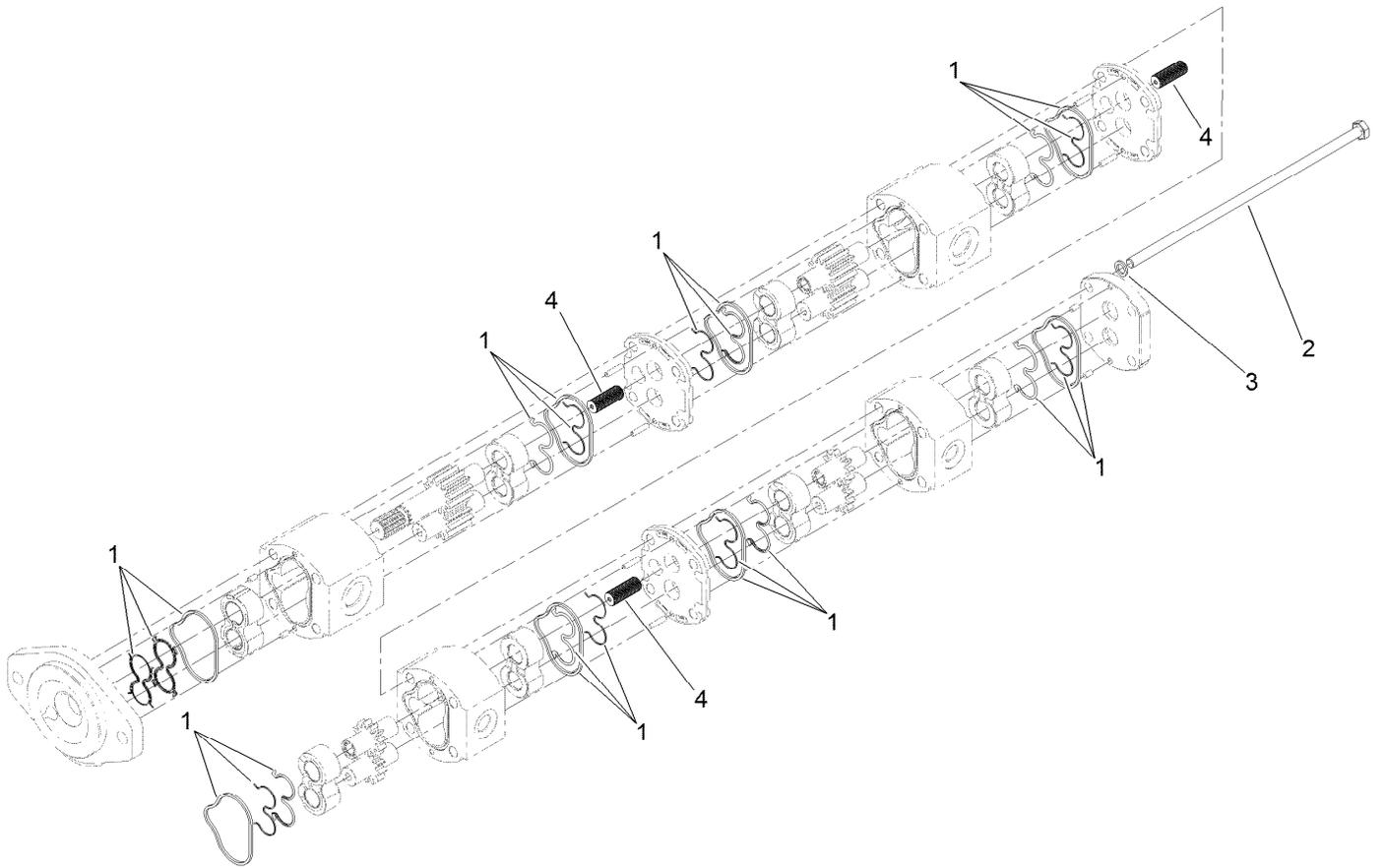

4-Section Gear Pump Assembly No. 120-8904 (continued)

<i>Ref.</i>	<i>Part Number</i>	<i>Qty.</i>	<i>Description</i>	<i>Ref.</i>	<i>Part Number</i>	<i>Qty.</i>	<i>Description</i>
1	115-3776	1	Seal Kit	3	121-1722	4	Washer
2	121-1721	4	Bolt	4	120-6284	3	Hub-Connecting

Hydraulic Pump Assembly No. 132-6100

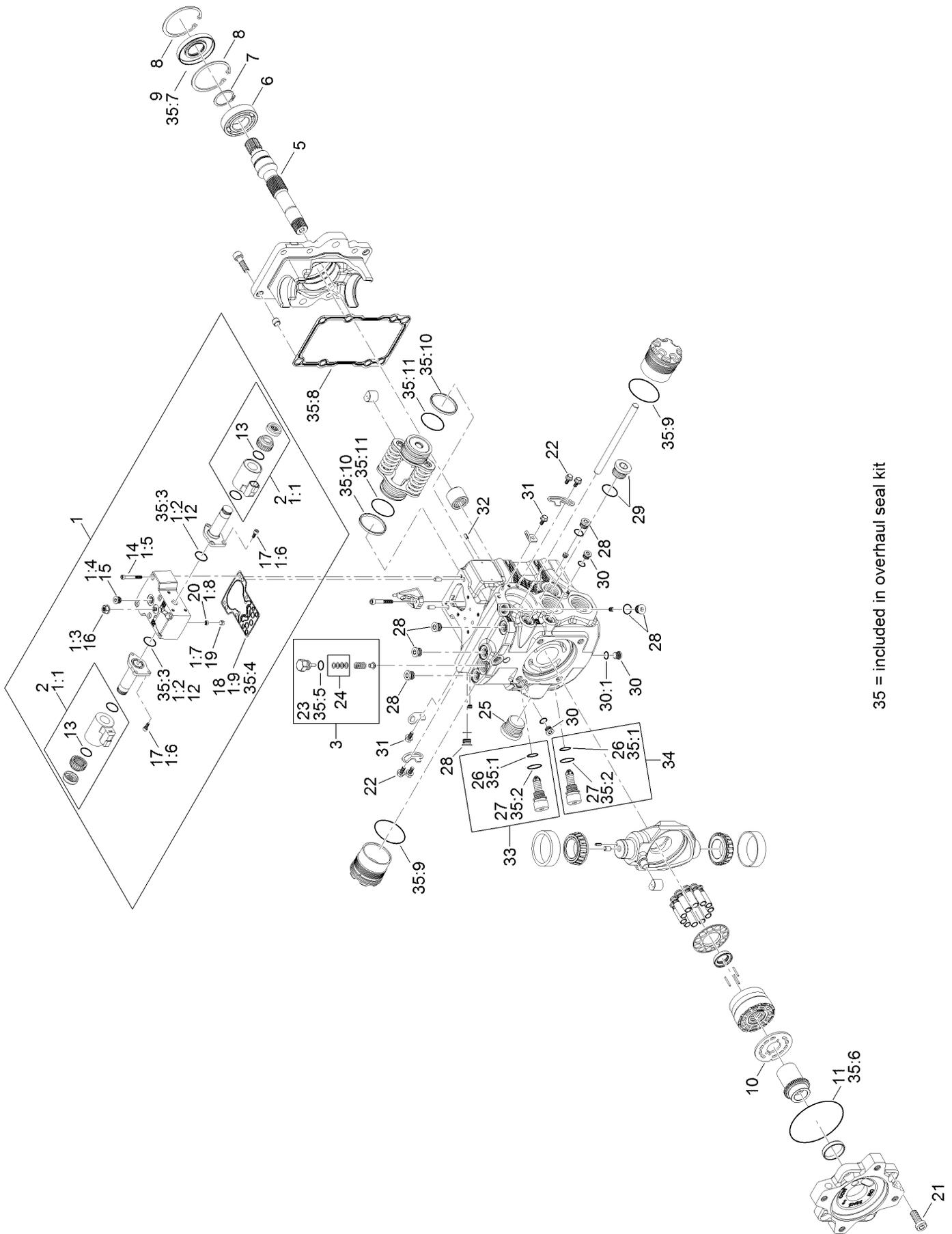

35 = included in overhaul seal kit

Hydraulic Pump Assembly No. 132-6100 (continued)

<i>Ref.</i>	<i>Part Number</i>	<i>Qty.</i>	<i>Description</i>	<i>Ref.</i>	<i>Part Number</i>	<i>Qty.</i>	<i>Description</i>
1	132-6203	1	Control Kit	21	125-5282	4	Screw
1:1	132-6204	2	Coil Kit	22	125-5270	4	Screw
1:2	125-5288	2	O-Ring	23	125-5298	1	O-Ring
1:3	125-5273	1	Nut-Seal	24	92-1353	1	Shim Kit
1:4	125-5302	1	Plug	25	125-5301	1	Plug
1:5	125-5274	6	Screw	26	75-0240	2	O-Ring
1:6	125-5272	6	Screw	27	84-0560	2	O-Ring
1:7	125-5269	1	Ring-Locking	28	69-3080	6	Plug
1:8	125-5266	1	Screen	29	69-3130	1	Plug
1:9	125-5283	1	Gasket-Control	30	75-0170	3	Plug-Thread, Straight
2	132-6204	2	Coil Kit	30:1	92-8777	1	O-Ring
3	136-4397	1	Charge Relief Kit	31	125-5270	2	Screw
5	136-4399	1	Shaft	32	110-6485	1	Pin-Slotted
6	75-0460	1	Bearing-Ball	33	136-4393	1	Valve-Relief, High Pressure
7	125-5280	1	Ring-Retaining	34	136-4392	1	Valve-Relief, High Pressure
8	131-8616	2	Ring-Retaining	35	132-6205	1	Overhaul Seal Kit
9	127-6214	1	Seal-Lip	35:1	75-0240	2	O-Ring
10	136-4398	1	Valve Plate	35:2	84-0560	2	O-Ring
11	132-6206	1	O-Ring	35:3	125-5288	2	O-Ring
12	125-5288	2	O-Ring	35:4	125-5283	1	Gasket-Control
13	131-7388	2	O-Ring	35:5	125-5298	1	O-Ring
14	125-5274	6	Screw	35:6	132-6206	1	O-Ring
15	125-5302	1	Plug	35:7	127-6214	1	Seal-Lip
16	125-5273	1	Nut-Seal	35:8		1	Gasket ●
17	125-5272	6	Screw	35:9		2	O-Ring ●
18	125-5283	1	Gasket-Control	35:10		2	Piston Ring ●
19	125-5269	1	Ring-Locking	35:11		2	O-Ring ●
20	125-5266	1	Screen				

● Not serviced separately

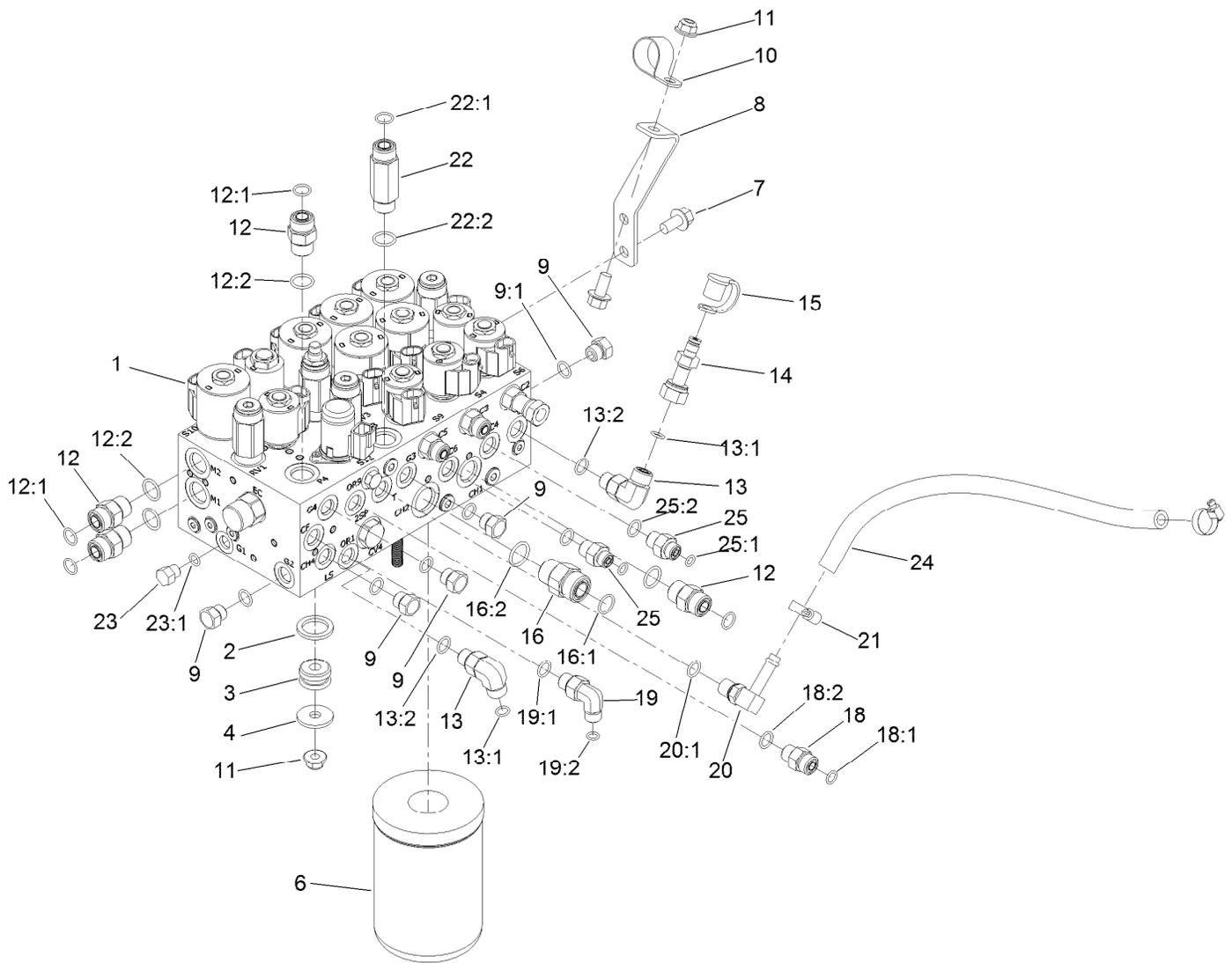

Combination Manifold Assembly

Ref.	Part Number	Qty.	Description	Ref.	Part Number	Qty.	Description
1	137-5582	1	Manifold-Combination	16:2	237-80	1	O-Ring
2	92-2650	3	Spacer-Clutch	18	340-2	1	Fitting-Straight
3	63-9750	3	Mount	18:1	237-22	1	O-Ring
4	63-8410	3	Washer	18:2	237-42	1	O-Ring
6	75-1310	1	Filter-HYD	19	340-82	1	Fitting-Elbow, 90 DEG
7	3234-1	3	Screw-HHF	19:1	237-42	1	O-Ring
8	121-1542	1	Plate-Mount, Hose	19:2	237-21	1	O-Ring
9	353-508	5	Plug-HH	20	100-4887	1	Fitting-Elbow, 90
9:1	237-42	1	O-Ring	20:1	237-42	1	O-Ring
10	2412-126	1	R-Clamp	21	2412-36	2	Clamp-Hose
11	104-8301	4	Nut-HF, NI	22	119-4854	1	Fitting-STR
12	340-4	4	Fitting-Straight	22:1	237-30	1	O-Ring
12:1	237-30	1	O-Ring	22:2	237-79	1	O-Ring
12:2	237-79	1	O-Ring	23	353-512	1	Plug
13	340-77	2	Fitting-Elbow, 90 DEG	23:1	237-78	1	O-Ring
13:1	237-22	1	O-Ring	24	87-5730	1	Hose
13:2	237-42	1	O-Ring	25	340-1	2	Fitting-Straight
14	86-5480	1	Nipple-Test	25:1	237-21	1	O-Ring
15	354-79	1	Cap-Dust	25:2	237-42	1	O-Ring
16	340-7	1	Fitting-Straight				
16:1	237-65	1	O-Ring				

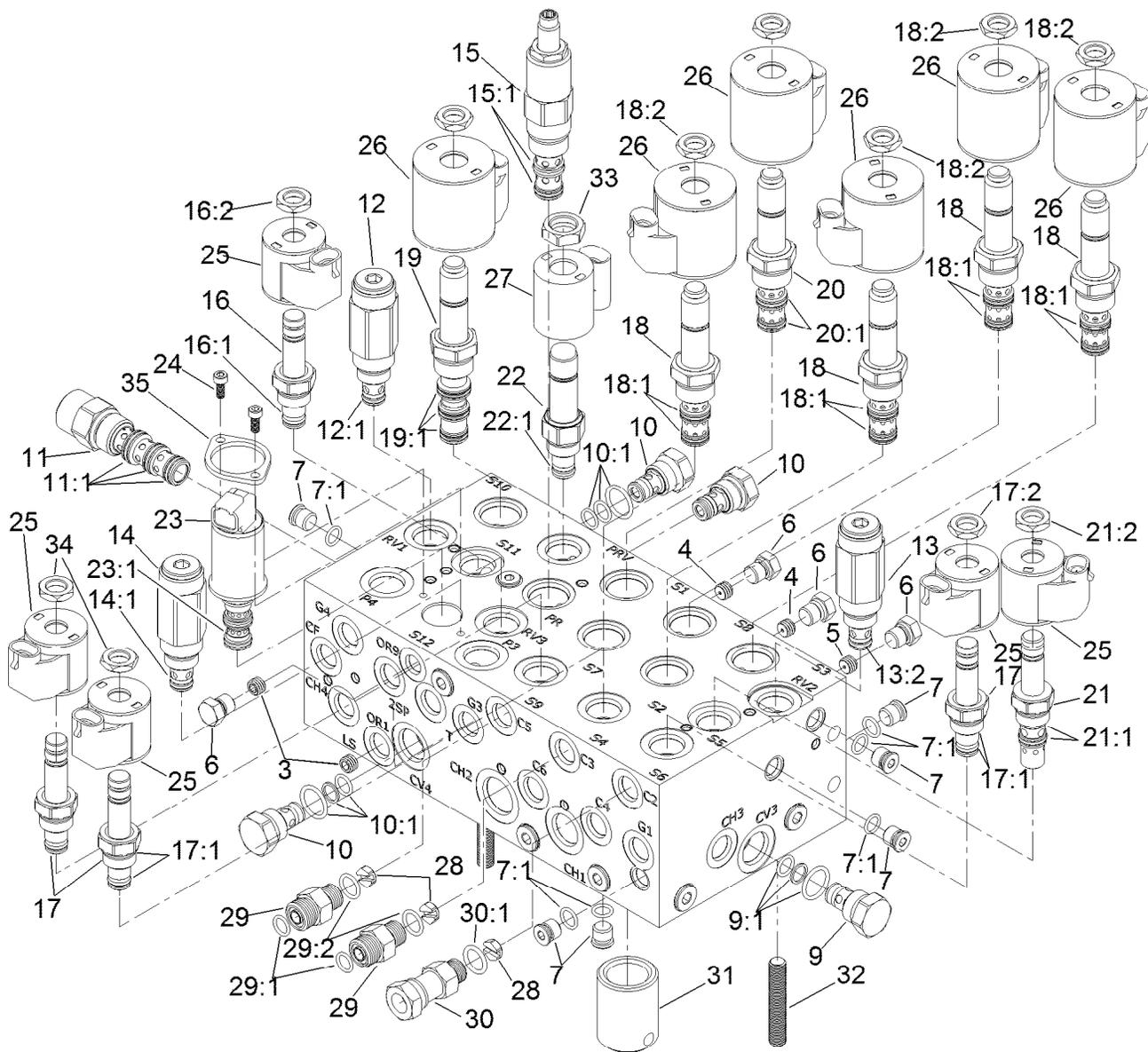

Combination Manifold Assembly No. 137-5582

Ref.	Part Number	Qty.	Description	Ref.	Part Number	Qty.	Description
3	136-4363	2	Orifice-0.028	16:1	105-9156	1	Seal Kit
4	112-6538	2	Orifice (.063 Inch)	16:2	110-2634	1	Nut-Coil
5	110-8883	1	Plug-Orifice (0.040)	17	112-9206	3	Solenoid Valve ASM
6	117-0115	4	Plug	17:1	105-9156	1	Seal Kit
7	353-990	14	Plug ASM	17:2	110-2634	1	Nut-Coil
7:1	237-78	1	O-Ring	18	115-5400	4	Solenoid Valve ASM
9	114-2873	1	Check Valve ASM	18:1	107-7813	1	Seal Kit
9:1	105-9156	1	Seal Kit	18:2	110-2634	1	Nut-Coil
10	105-9321	3	Check Valve ASM	19	115-3023	1	Solenoid Valve ASM
10:1	105-9156	1	Seal Kit	19:1	110-8908	1	Spool Valve Seal Kit
11	115-5409	1	Compensator ASM	20	125-7556	1	Solenoid Valve ASM
11:1	110-8908	1	Spool Valve Seal Kit	20:1	107-7813	1	Seal Kit
12	125-7560	1	Relief Valve ASM	21	115-5405	1	Solenoid Valve ASM
12:1	105-9156	1	Seal Kit	21:1	115-5413	1	Seal Kit
13	105-9844	1	Valve-Relief	21:2	110-2634	1	Nut-Coil
13:2	105-9156	1	Seal Kit	22	125-7555	1	Proportional Relief Valve ASM
14	125-7558	1	Relief Valve ASM	22:1	110-6316	1	Seal Kit
14:1	105-9156	1	Seal Kit	23	138-3828	1	Valve-Solenoid, 3 Way 2 Position
15	127-3663	1	Valve-Pressure Reducing	23:1	138-3831	1	Seal Kit
15:1	105-9154	1	Seal Kit				
16	107-7516	1	Solenoid Valve ASM				

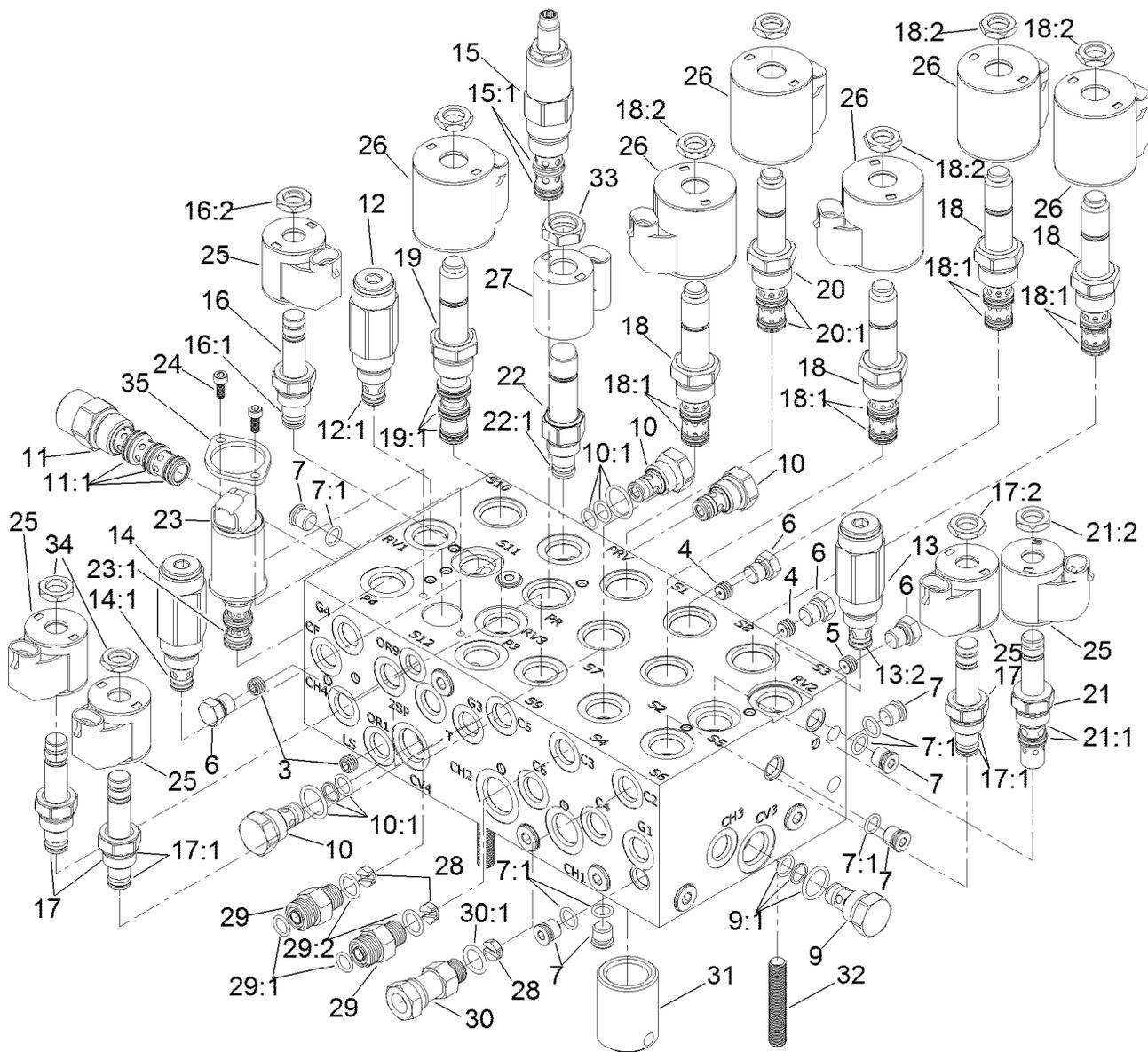

Combination Manifold Assembly No. 137-5582 (continued)

Ref.	Part Number	Qty.	Description	Ref.	Part Number	Qty.	Description
24	138-3827	2	Screw	30	104-3779	1	Connector-Swivel, Straight
25	110-0497	5	Coil-Solenoid	30:1	237-42	1	O-Ring
26	110-6344	6	Coil-12V, DC	31	125-7551	1	Nipple-Filter
27	125-7553	1	E-Coil, 12Vdc	32	130-2661	3	Stud-Manifold
28	125-7552	3	Orifice-Check, .070 DIA	33	125-7550	1	Nut-Coil
29	340-2	2	Fitting-Straight	34	110-2634	11	Nut-Coil
29:1	237-22	1	O-Ring	35	138-3825	1	Plate-Mounting, Standard
29:2	237-42	1	O-Ring				

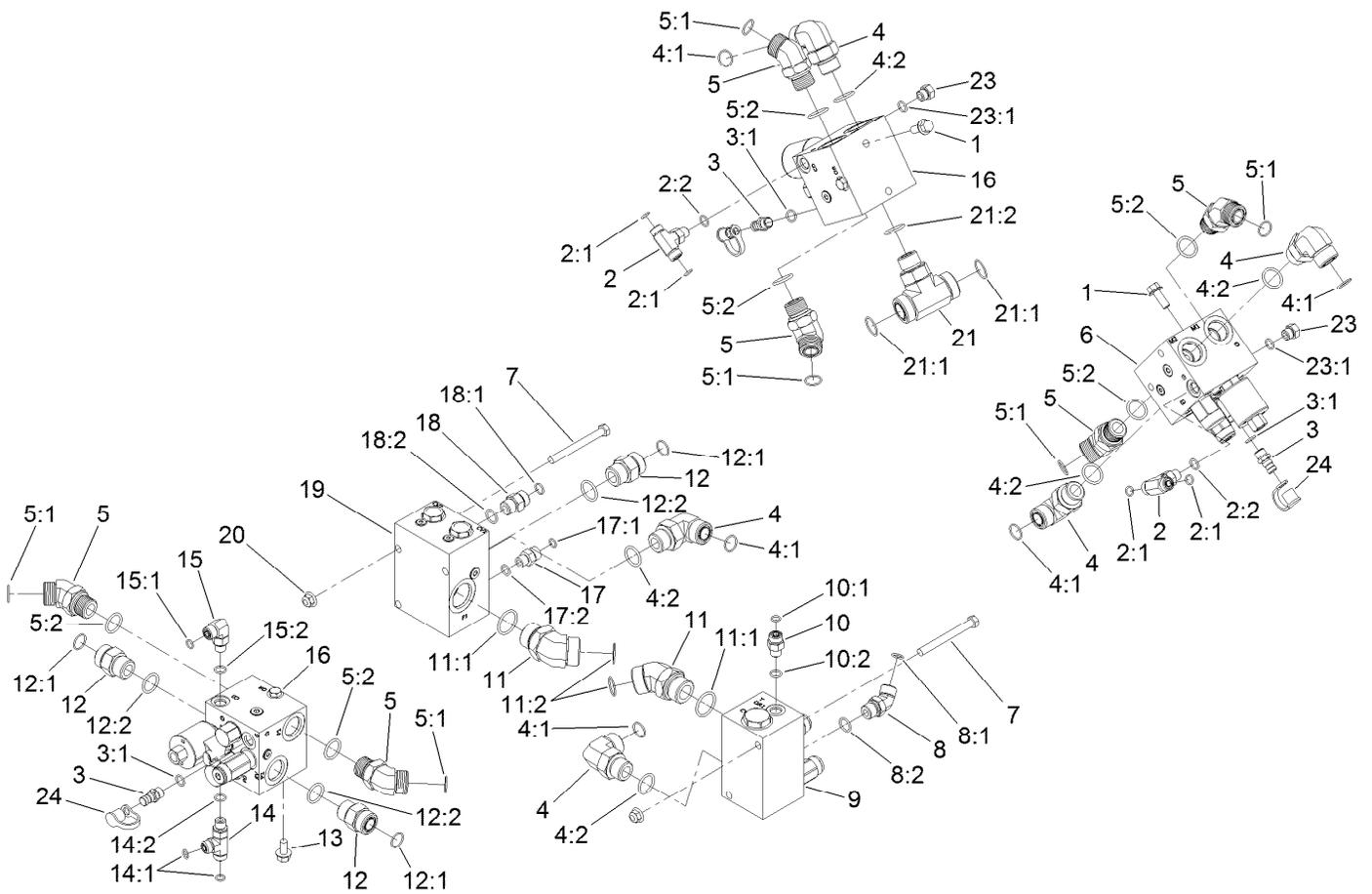

Manifold Block Assembly

Ref.	Part Number	Qty.	Description	Ref.	Part Number	Qty.	Description
1	3234-11	4	Screw-HHF	11	104-3509	2	Fitting-HYD, 45 DEG
2	340-94	2	Adapter	11:1	237-146	1	O-Ring
2:1	237-22	2	O-Ring	11:2	340-65	1	O-Ring
2:2	237-42	1	O-Ring	12	340-9	3	Fitting-STR
3	59-7410	3	Fitting-Diagnostic	12:1	237-58	1	O-Ring
3:1	237-42	1	O-Ring	12:2	237-81	1	O-Ring
4	340-142	5	Fitting-Elbow, 90 DEG	13	3234-1	2	Screw-HHF
4:1	237-58	1	O-Ring	14	340-86	1	Fitting-Tee
4:2	237-81	1	O-Ring	14:1	237-22	2	O-Ring
5	100-5530	6	Fitting-45 DEG	14:2	237-42	1	O-Ring
5:1	237-58	1	O-Ring	15	340-77	1	Fitting-Elbow, 90 DEG
5:2	237-81	1	O-Ring	15:1	237-22	1	O-Ring
6	131-1249	1	Manifold-PTO, Left	15:2	237-42	1	O-Ring
7	323-42	4	Screw-HH	16	131-1248	2	Center And Right PTO Manifold ASM
8	340-101	1	Fitting-HYD, 45 DEG	17	92-9258	1	Adapter-Check
8:1	237-30	1	O-Ring	17:1	237-22	1	O-Ring
8:2	237-79	1	O-Ring	17:2	237-42	1	O-Ring
9	121-1530	1	Manifold-Traction, Rear	18	100-4890	1	Fitting-Check
10	340-2	1	Fitting-Straight	18:1	237-79	1	O-Ring
10:1	237-22	1	O-Ring	18:2	237-30	1	O-Ring
10:2	237-42	1	O-Ring				

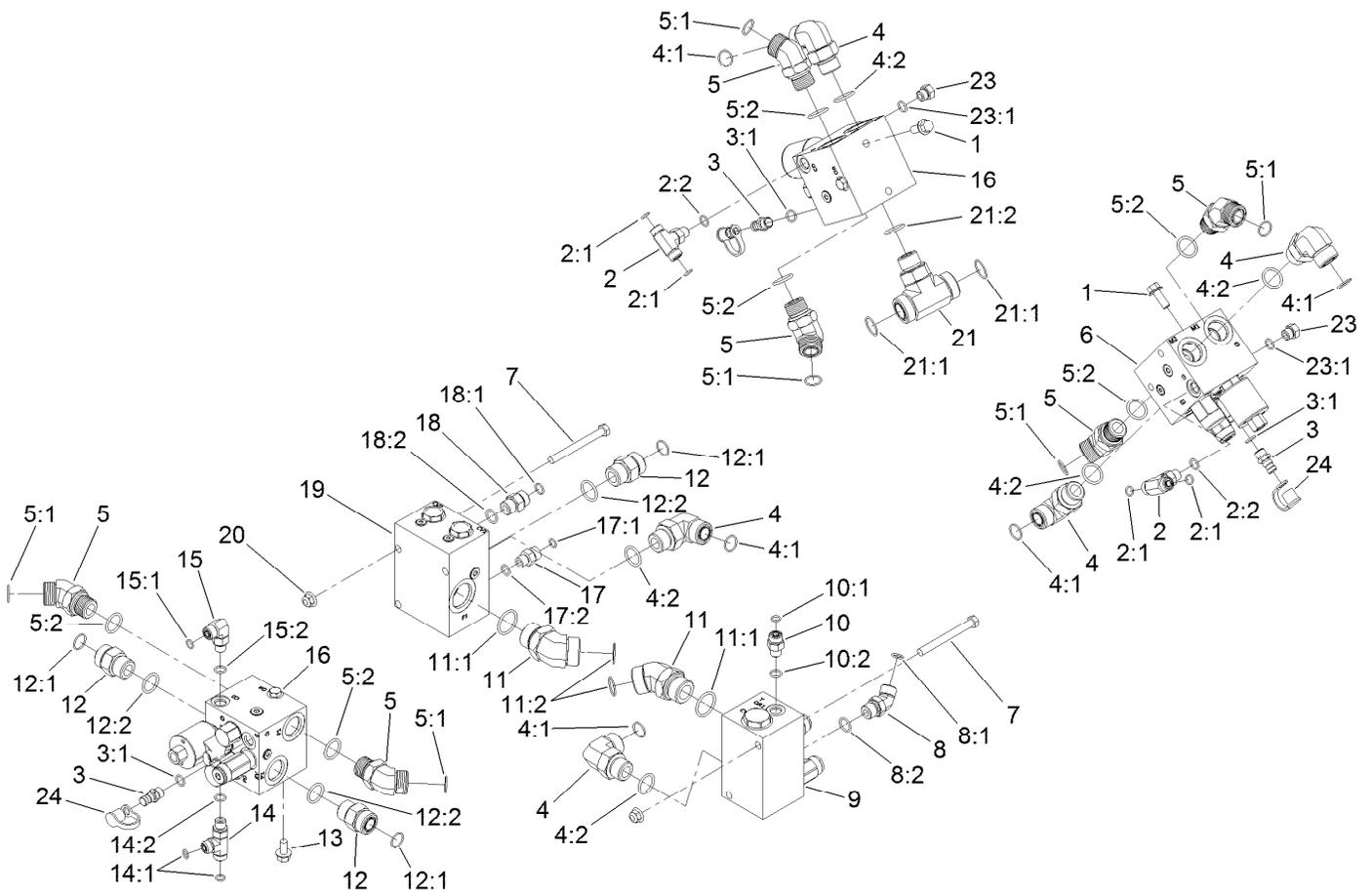

Manifold Block Assembly (continued)

<i>Ref.</i>	<i>Part Number</i>	<i>Qty.</i>	<i>Description</i>	<i>Ref.</i>	<i>Part Number</i>	<i>Qty.</i>	<i>Description</i>
19	121-1550	1	Flow Divider Manifold ASM	21:2	237-81	1	O-Ring
20	104-8301	4	Nut-HF, NI	23	353-508	2	Plug-HH
21	120-8825	1	Fitting-Tee	23:1	237-42	1	O-Ring
21:1	340-65	2	O-Ring	24	354-79	3	Cap-Dust

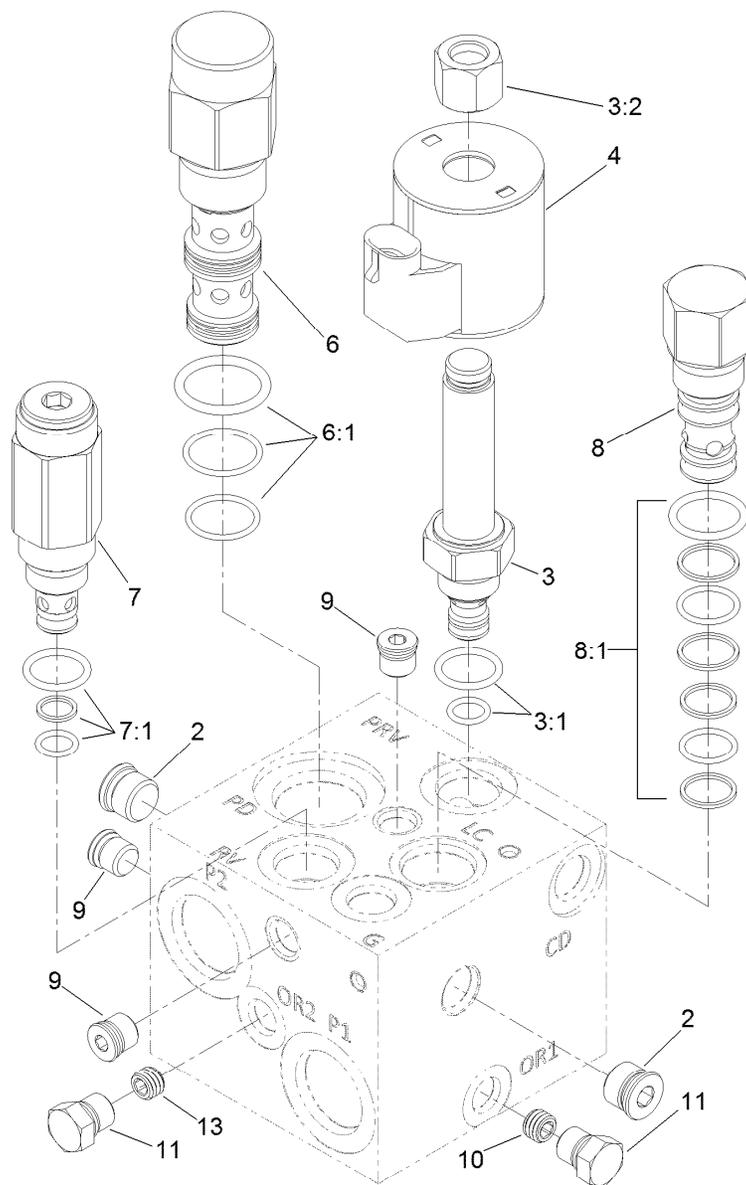

Left PTO Manifold Assembly No. 131-1249

Ref.	Part Number	Qty.	Description
2	112-9213	2	Plug
3	117-0227	1	Valve-Relief, Proportional
3:1	105-9156	1	Seal Kit
3:2	130-8180	1	Nut-Coil (9/16-24 Unef-2B)
4	110-6344	1	Coil-12V, DC
6	125-4327	1	Valve-Directional, Pilot
6:1	114-5515	1	Seal Kit
7	114-5512	1	Valve-Relief, 600 PSI
7:1	105-9156	1	Seal Kit
8	105-9153	1	Element-Logic, Vented
8:1	119-2159	1	Seal Kit
9	112-9212	3	Plug
10	117-8315	1	Orifice (.025 Inch)
11	117-0115	2	Plug
13	112-6538	1	Orifice (.063 Inch)

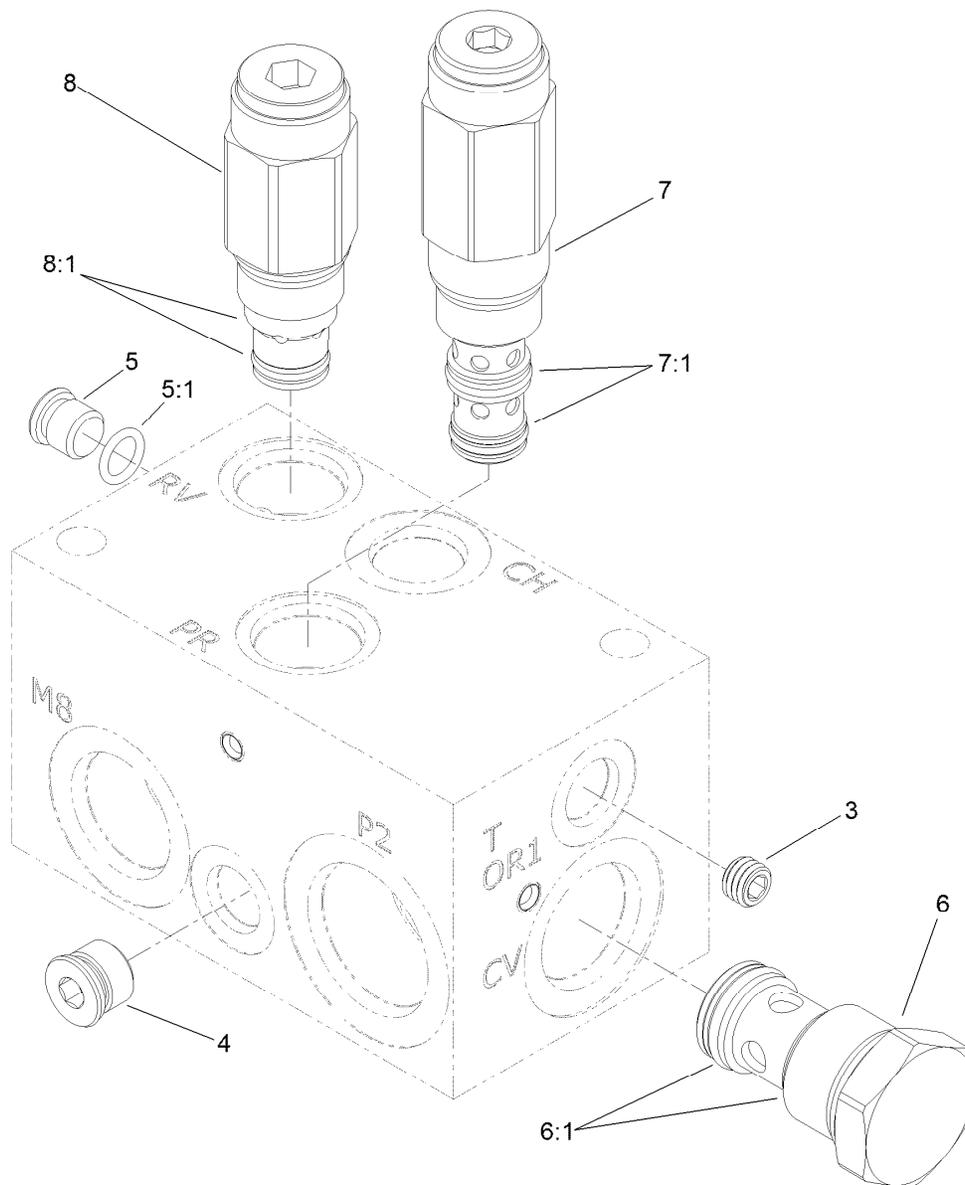

Rear Traction Manifold Assembly No. 121-1530

Ref.	Part Number	Qty.	Description
3	110-0495	1	Plug-Orifice (0.050 Inch)
4		1	Plug ●
5	353-990	1	Plug ASM
5:1	237-78	1	O-Ring
6	125-4328	1	Valve-Check
6:1	125-4336	1	Seal Kit
7	136-4362	1	Valve-Reducing
7:1	136-4361	1	Seal Kit
8	125-4331	1	Valve-Relief
8:1	110-6316	1	Seal Kit

● Not serviced separately

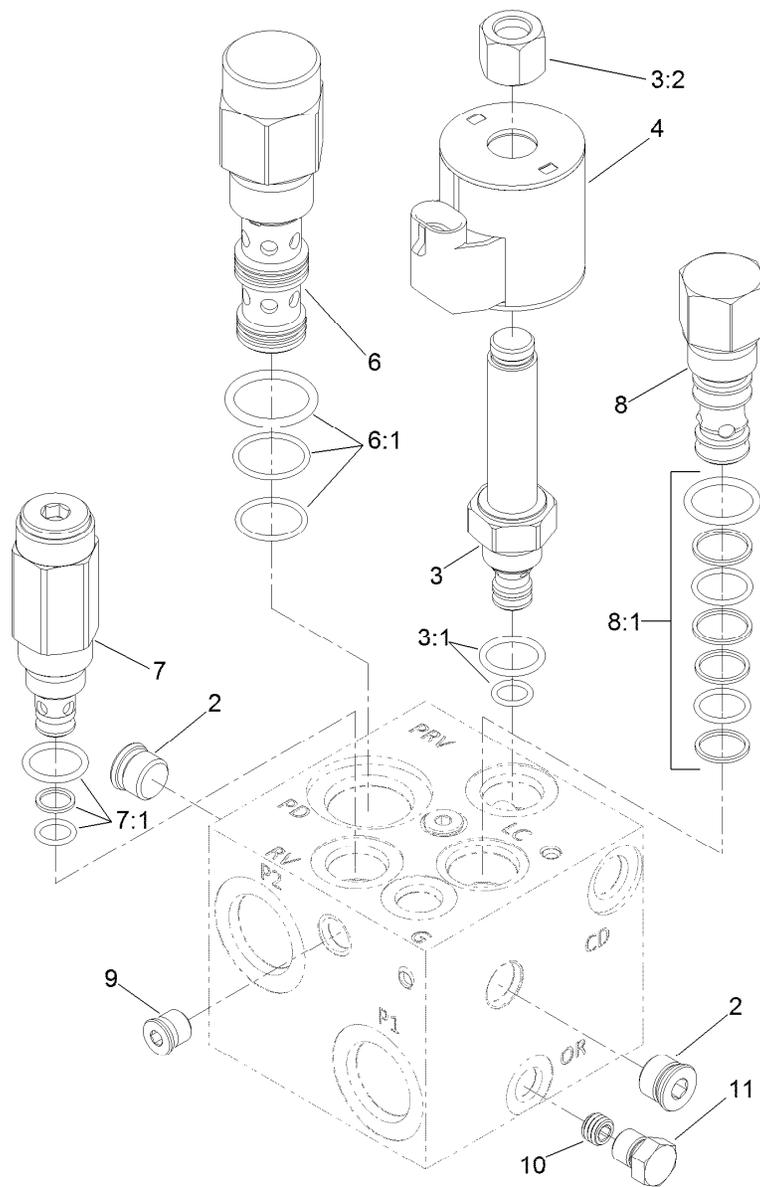

Center and Right PTO Manifold Assembly No. 131-1248

Ref.	Part Number	Qty.	Description
2	112-9213	2	Plug
3	117-0227	1	Valve-Relief, Proportional
3:1	105-9156	1	Seal Kit
3:2	130-8180	1	Nut-Coil (9/16-24 Unef-2B)
4	110-6344	1	Coil-12V, DC
6	125-4327	1	Valve-Directional, Pilot
6:1	114-5515	1	Seal Kit
7	114-5512	1	Valve-Relief, 600 PSI
7:1	105-9156	1	Seal Kit
8	105-9153	1	Element-Logic, Vented
8:1	119-2159	1	Seal Kit
9	112-9212	3	Plug
10	117-8315	1	Orifice (.025 Inch)
11	117-0115	1	Plug

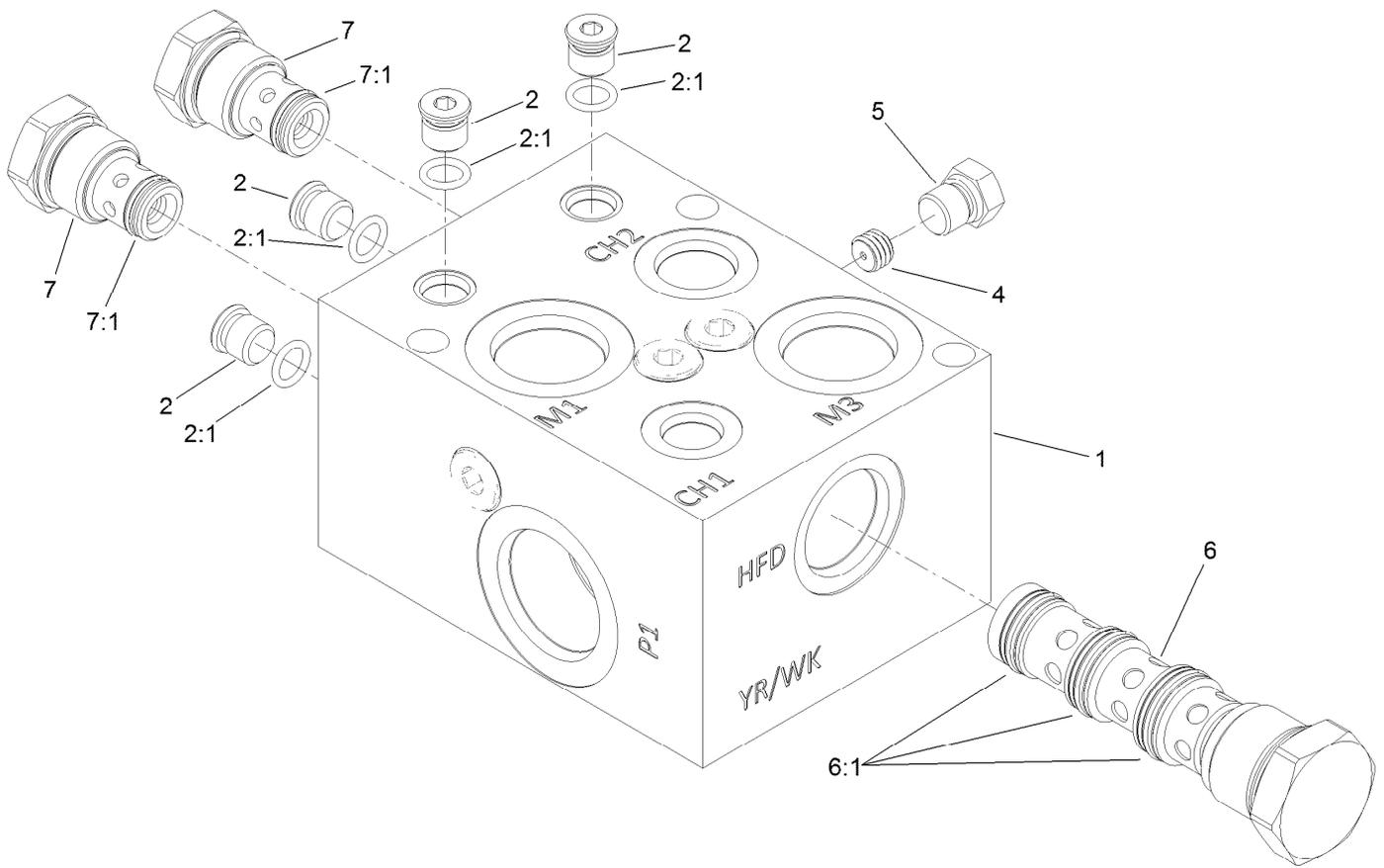

Flow Divider Manifold Assembly No. 121-1550

<i>Ref.</i>	<i>Part Number</i>	<i>Qty.</i>	<i>Description</i>
1		1	Manifold Block ●
2	353-990	4	Plug ASM
2:1	237-78	1	O-Ring
4	112-6538	1	Orifice (.063 Inch)
5	117-0115	1	Plug
6	125-4332	1	Valve-Flow Divider
6:1	125-4338	1	Seal Kit
7	125-4333	2	Valve-Check
7:1	125-4337	1	Seal Kit

● Not serviced separately

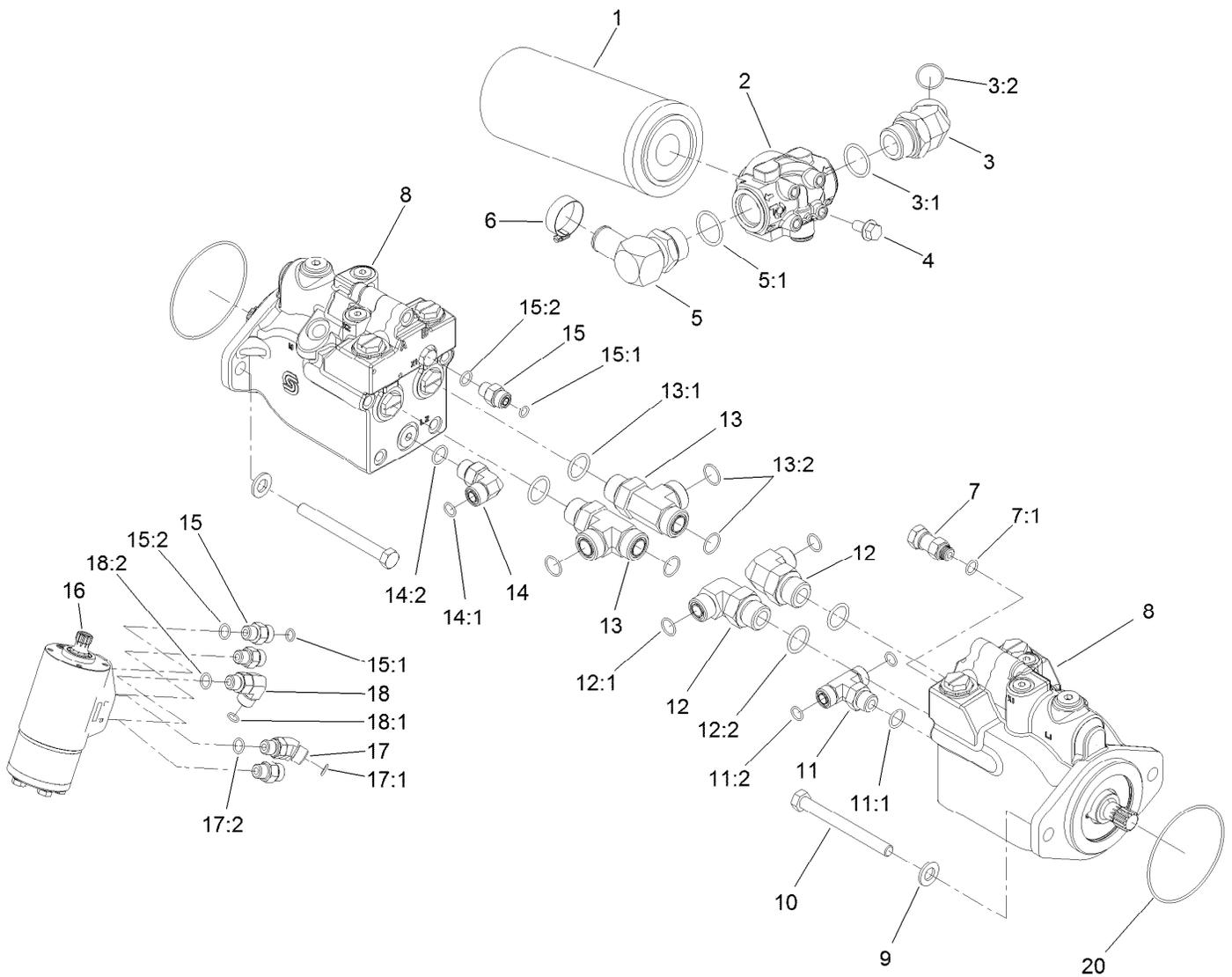

Drive Motor, Steer Valve and Filter Head Assembly

Ref.	Part Number	Qty.	Description	Ref.	Part Number	Qty.	Description
1	94-2621	1	Element-Filter	12:2	237-65	1	O-Ring
2	121-1577	1	Head-Filter	13	340-148	2	Fitting-Tee
3	104-3509	1	Fitting-HYD, 45 DEG	13:1	237-81	1	O-Ring
3:1	237-146	1	O-Ring	13:2	237-58	2	O-Ring
3:2	340-65	1	O-Ring	14	340-98	1	Fitting-Elbow, 90 DEG
4	3234-1	4	Screw-HHF	14:1	237-79	1	O-Ring
5	23-8910	1	Stem-Barb-90	14:2	237-30	1	O-Ring
5:1	237-146	1	O-Ring	15	340-2	4	Fitting-Straight
6	2412-34	1	Clamp-Hose	15:1	237-22	1	O-Ring
7	104-3779	1	Connector-Swivel, Straight	15:2	237-42	1	O-Ring
7:1	237-42	1	O-Ring	16	132-6256	1	Valve-Steer
8	120-8812	2	HYD Motor ASM	17	340-87	1	Fitting-Elbow, 45 DEG
9	106-9888	4	Washer-Flat	17:1	237-22	1	O-Ring
10	33116-110	4	Screw-HH	17:2	237-42	1	O-Ring
11	340-157	1	Fitting-HYD, Tee	18	340-77	1	Fitting-Elbow, 90 DEG
11:1	237-79	1	O-Ring	18:1	237-22	1	O-Ring
11:2	237-30	2	O-Ring	18:2	237-42	1	O-Ring
12	340-139	2	Fitting-Elbow 90	20	237-166	2	O-Ring
12:1	237-81	1	O-Ring				

Hydraulic Motor Assembly No. 120-8812

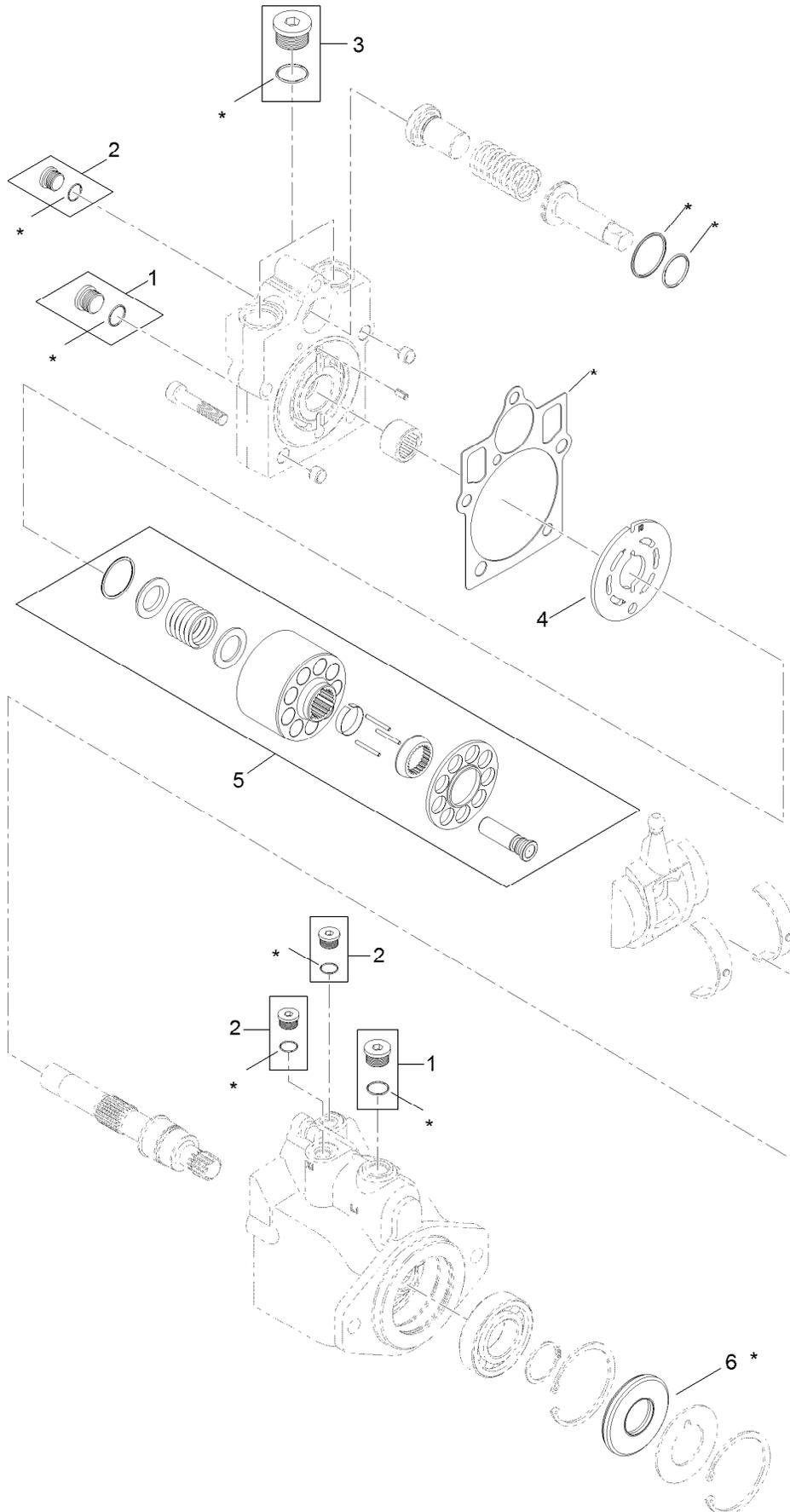

7 = all items with * are included in overhaul seal kit

Hydraulic Motor Assembly No. 120-8812 (continued)

<i>Ref.</i>	<i>Part Number</i>	<i>Qty.</i>	<i>Description</i>	<i>Ref.</i>	<i>Part Number</i>	<i>Qty.</i>	<i>Description</i>
1	67-9090	2	Plug	5	121-1735	1	Cylinder Block Kit
2	75-0070	3	Plug	6	69-3190	1	Seal-Lip
3	107-4352	1	Plug	7	121-1736	1	Overhaul Seal Kit
4	121-1734	1	Plate-Valve				

Steering Valve Assembly No. 132-6256

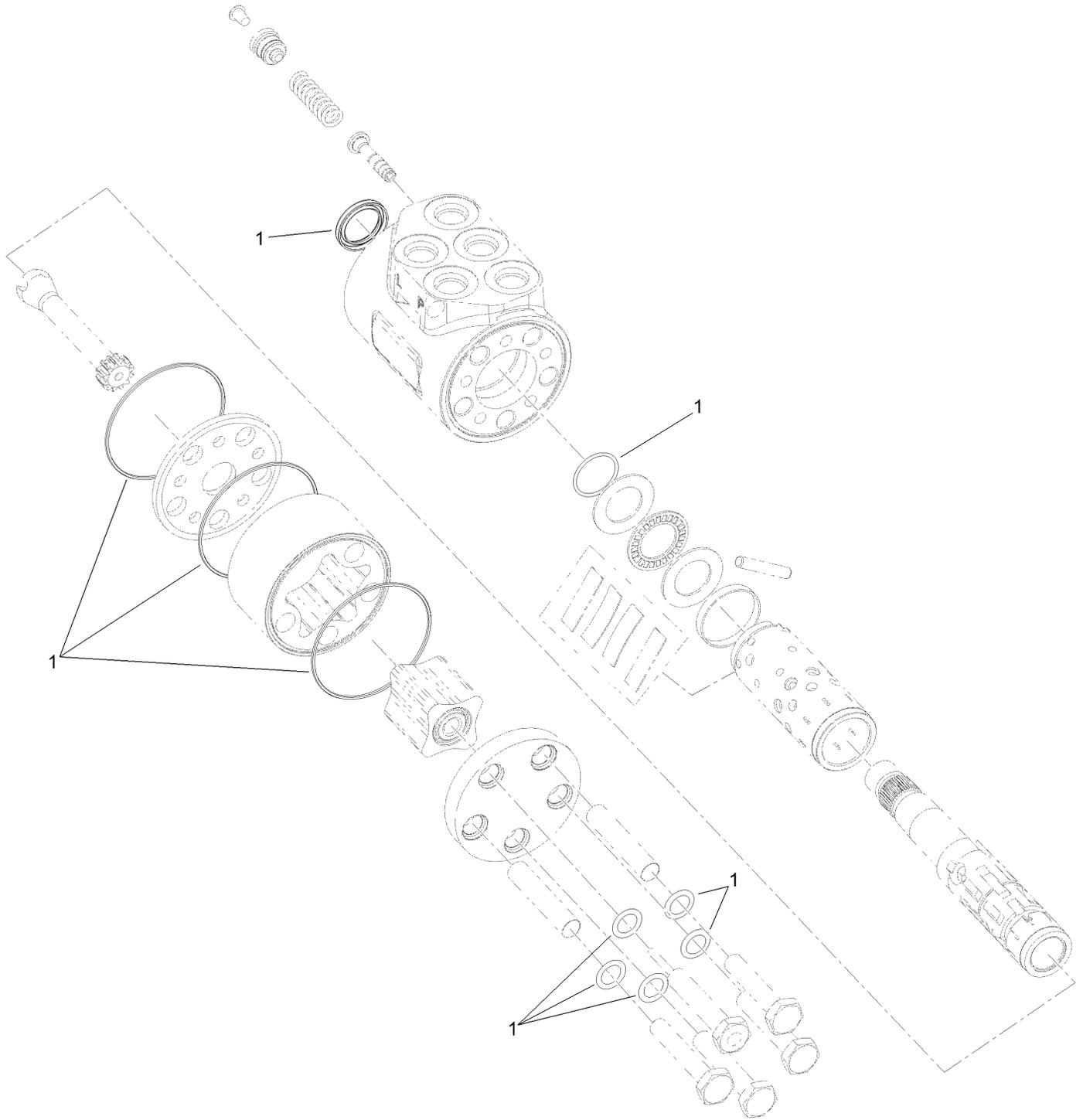

Steering Valve Assembly No. 132-6256 (continued)

<i>Ref.</i>	<i>Part Number</i>	<i>Qty.</i>	<i>Description</i>
1	106-6716	1	Seal Kit

Hydraulic Reservoir Assembly

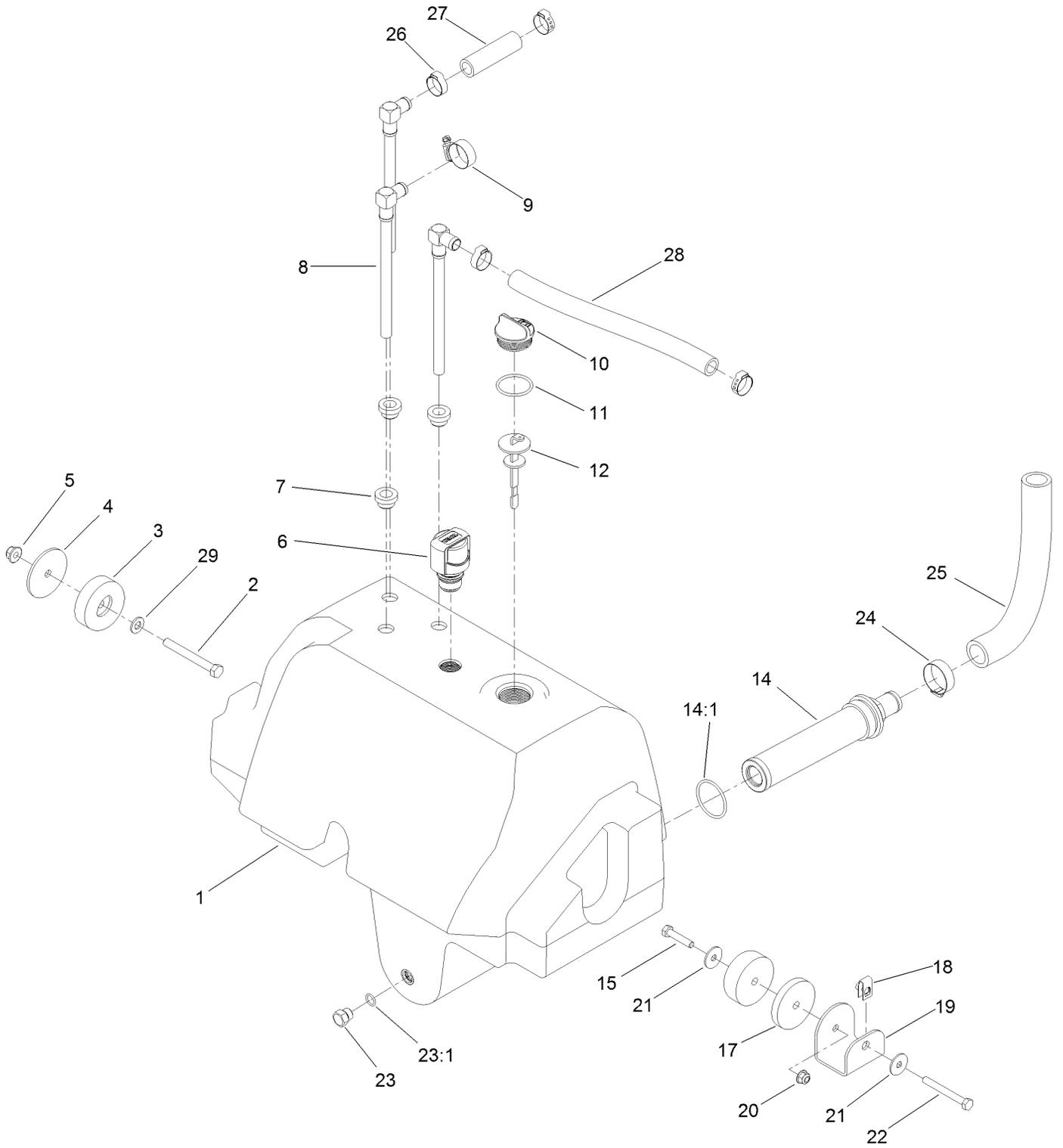

Hydraulic Reservoir Assembly (continued)

<i>Ref.</i>	<i>Part Number</i>	<i>Qty.</i>	<i>Description</i>	<i>Ref.</i>	<i>Part Number</i>	<i>Qty.</i>	<i>Description</i>
1	120-9077	1	Reservoir-HYD	17	121-1533	1	Spacer-Thick
2	323-20	1	Screw-HH	18	115-7721	1	Nut-Clip, U
3	108-1605	2	Bumper-Recess	19	121-1557-03	1	Mount-Tank
4	121-1456	1	Spacer-Thin	20	104-8300	1	Nut-HF, NI
5	104-8301	1	Nut-HF, NI	21	3256-82	2	Washer-Flat
6	115-9793	1	Breather	22	322-13	1	Screw-HH
7	104-0790	3	Bushing	23	353-508	1	Plug-HH
8	114-0002	3	Pipe-Stand	23:1	237-42	1	O-Ring
9	2412-129	1	Clamp-Hose	24	2412-34	1	Clamp-Hose
10	93-7498	1	Plug-Plastic	25	120-8810	1	Hose-Strainer
11	237-101	1	O-Ring	26	115-5436	4	Clamp-Hose, Crimp
12	112-6365	1	Dipstick	27	114-4920	1	Hose
14	104-7546	1	Tank Strainer ASM	28	121-1521	1	Hose
14:1	340-136	1	O-Ring	29	3256-24	1	Washer-Plain
15	322-7	1	Screw-HH				

Lift, Steer and Fan Hydraulic Assembly

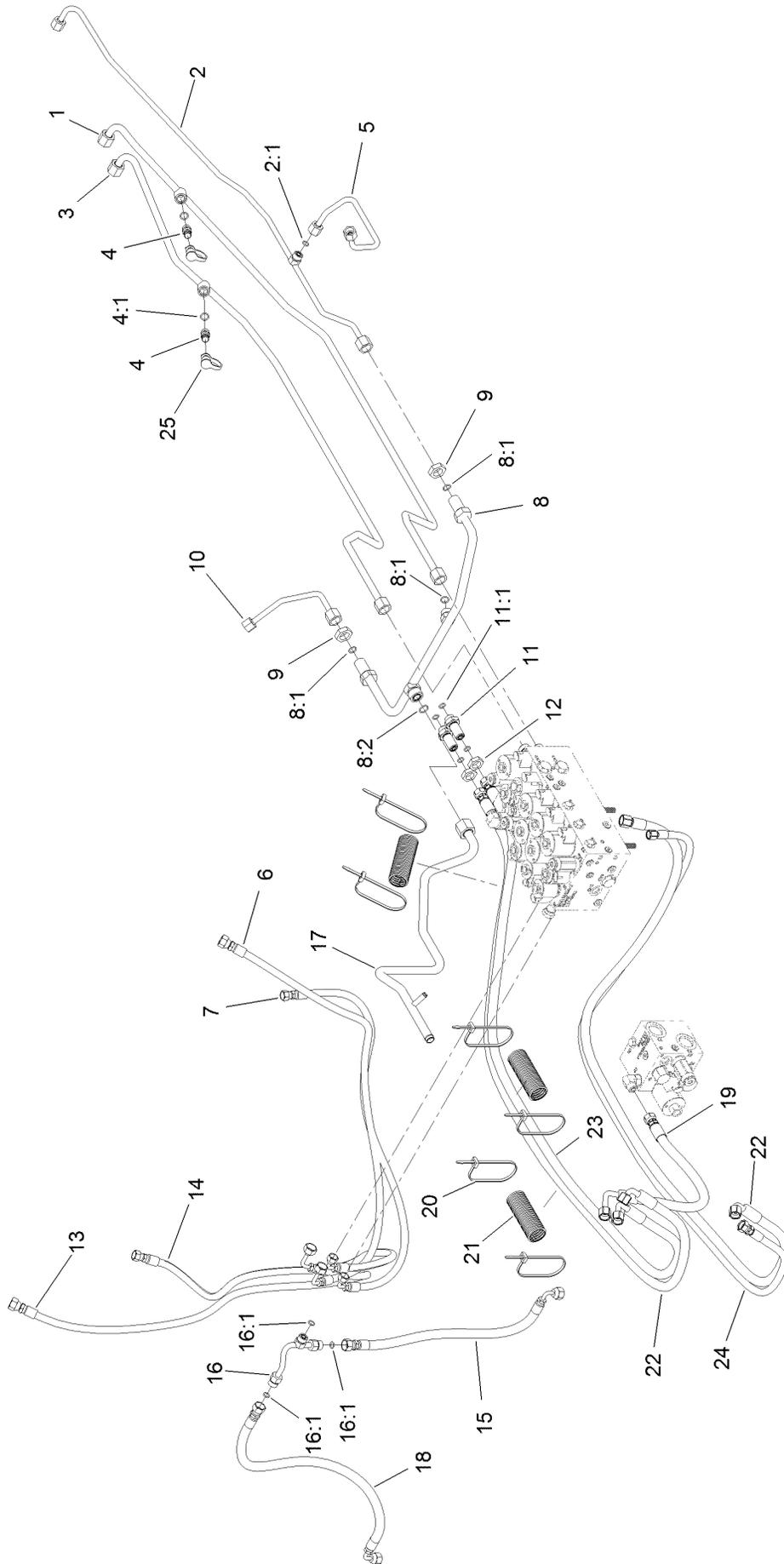

Lift, Steer and Fan Hydraulic Assembly (continued)

<i>Ref.</i>	<i>Part Number</i>	<i>Qty.</i>	<i>Description</i>	<i>Ref.</i>	<i>Part Number</i>	<i>Qty.</i>	<i>Description</i>
1	120-9074	1	Tube-Fan	12	340-70	2	Nut-Lock
2	120-8966	1	Tube-Drain, Fan	13	127-3736	1	Hose-HYD
2:1	237-22	1	O-Ring	14	100-3833	1	Hose-HYD
3	120-9075	1	Tube-Fan	15	121-1567	1	Hose-HYD
4	59-7410	2	Fitting-Diagnostic	16	121-1565	1	Tube-Tee
4:1	237-42	1	O-Ring	16:1	237-22	3	O-Ring
5	132-6145	1	Tube-HYD	17	121-1510	1	Tube-HYD
6	127-3737	1	Hose-HYD	18	121-1566	1	Hose-HYD
7	127-3738	1	Hose-HYD	19	139-0950	1	Hose ASM
8	121-1509	1	Tube-HYD	20	3290-378	7	Tie-Cable
8:1	237-30	3	O-Ring	21	121-1544	3	Cover-Hose
8:2	237-65	1	O-Ring	22	137-5575	2	Hose ASM
9	340-127	2	Nut-Bulkhead	23	137-5577	1	Hose ASM
10	132-6146	1	Tube-HYD	24	137-5576	1	Hose ASM
11	340-71	2	Fitting-Straight, Bulkhead	25	354-79	2	Cap-Dust
11:1	237-22	2	O-Ring				

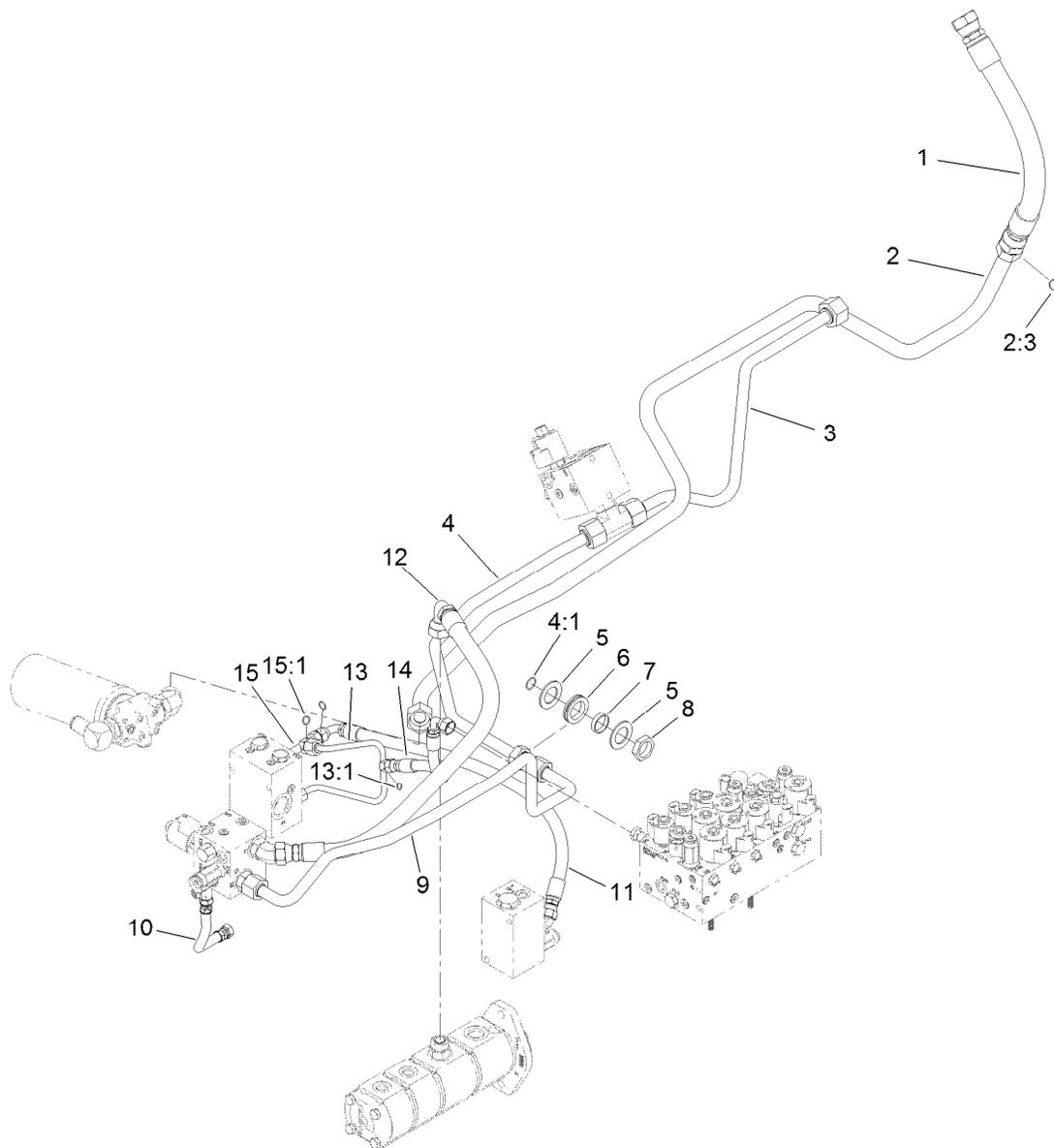

Oil Cooler Hydraulic Assembly

<i>Ref.</i>	<i>Part Number</i>	<i>Qty.</i>	<i>Description</i>	<i>Ref.</i>	<i>Part Number</i>	<i>Qty.</i>	<i>Description</i>
1	120-9060	1	Hose-HYD	9	120-8838	1	Tube-PTO, Front Return
2	121-1612	1	Tube ASM	10	121-1572	1	Hose-HYD
2:3	340-65	1	O-Ring	11	121-1559	1	Hose-HYD
3	121-1626	1	Tube-HYD	12	115-4384	1	Hose-HYD
4	121-1507	1	Tube ASM	13	121-1584	1	Tube-HYD
4:1	237-58	1	O-Ring	13:1	237-22	1	O-Ring
5	69-8910	2	Washer	14	121-1583	1	Hose-HYD
6	240-7	1	Grommet-Rubber	15	121-1558	1	Fitting-Tee
7	69-8900	1	Spacer	15:1	237-30	2	O-Ring
8	340-126	1	Nut-Bulkhead				

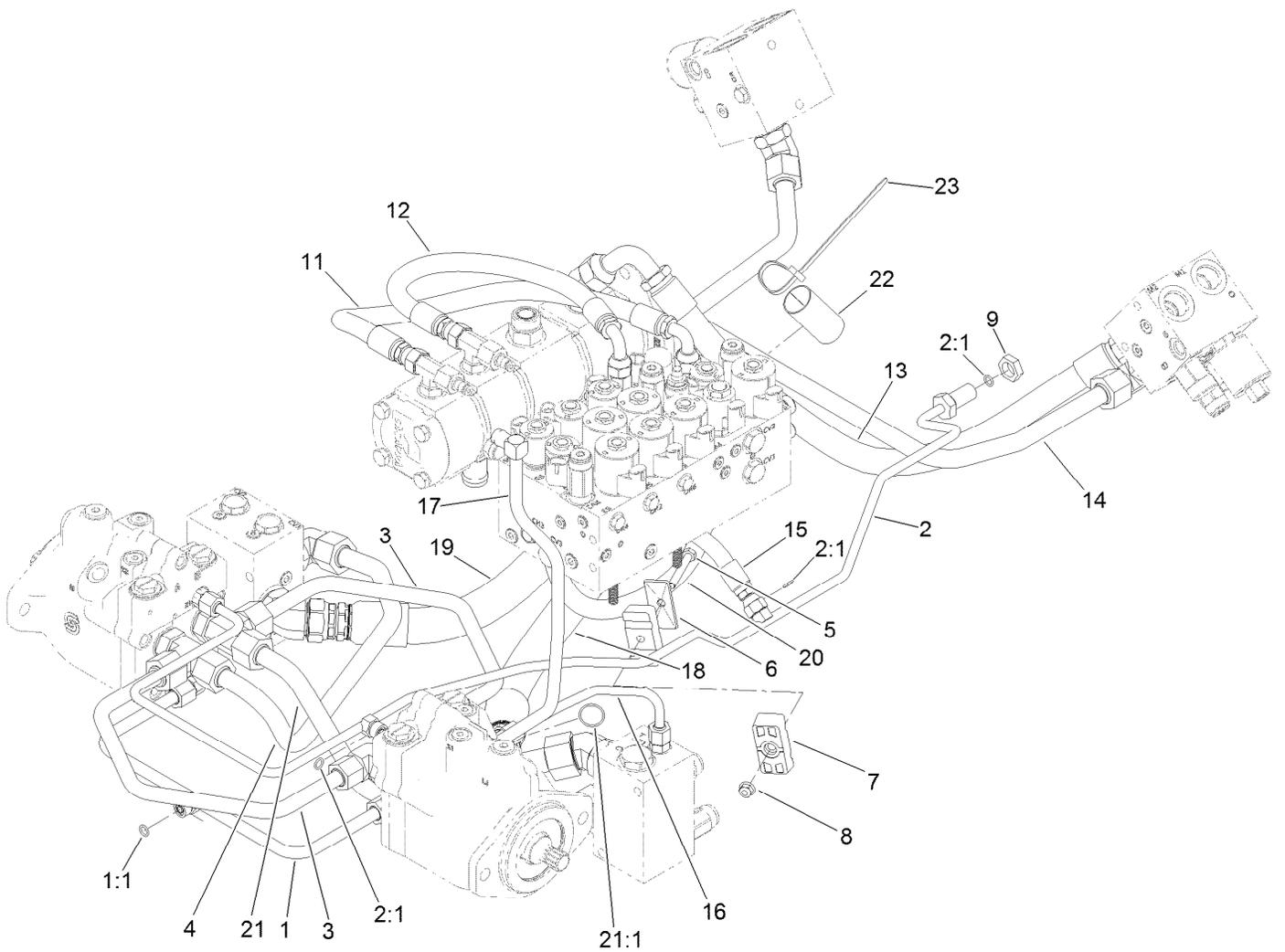

Traction Hydraulic Assembly

<i>Ref.</i>	<i>Part Number</i>	<i>Qty.</i>	<i>Description</i>	<i>Ref.</i>	<i>Part Number</i>	<i>Qty.</i>	<i>Description</i>
1	120-9080	1	Tube ASM	13	115-4384	1	Hose-HYD
1:1	237-22	1	O-Ring	14	120-8834	1	Tube-PTO, LH To RH
2	121-1552	1	Tube ASM	15	104-2234	1	Hose-HYD
2:1	237-22	3	O-Ring	16	121-1480	1	Tube-HYD
3	120-9079	2	Tube-HYD	17	120-8961	1	Tube-Return, Front
4	121-1546	1	Tube-HYD	18	132-6142	1	Hose-HYD
5	322-11	1	Screw-HH	19	132-6141	1	Hose-HYD
6	69-9761	1	Plate-Cover	20	132-6241	1	Hose-HYD
7	120-3200	2	Clamp-Tube	21	121-1581	1	Tube-Tee
8	104-8300	1	Nut-HF, NI	21:1	340-65	1	O-Ring
9	340-70	1	Nut-Lock	22	AU112950	1	Protector-Hose
11	104-2807	1	Hose-HYD	23	3290-378	3	Tie-Cable
12	104-4584	1	Hose-HYD				

Armrest Control Panel Assembly

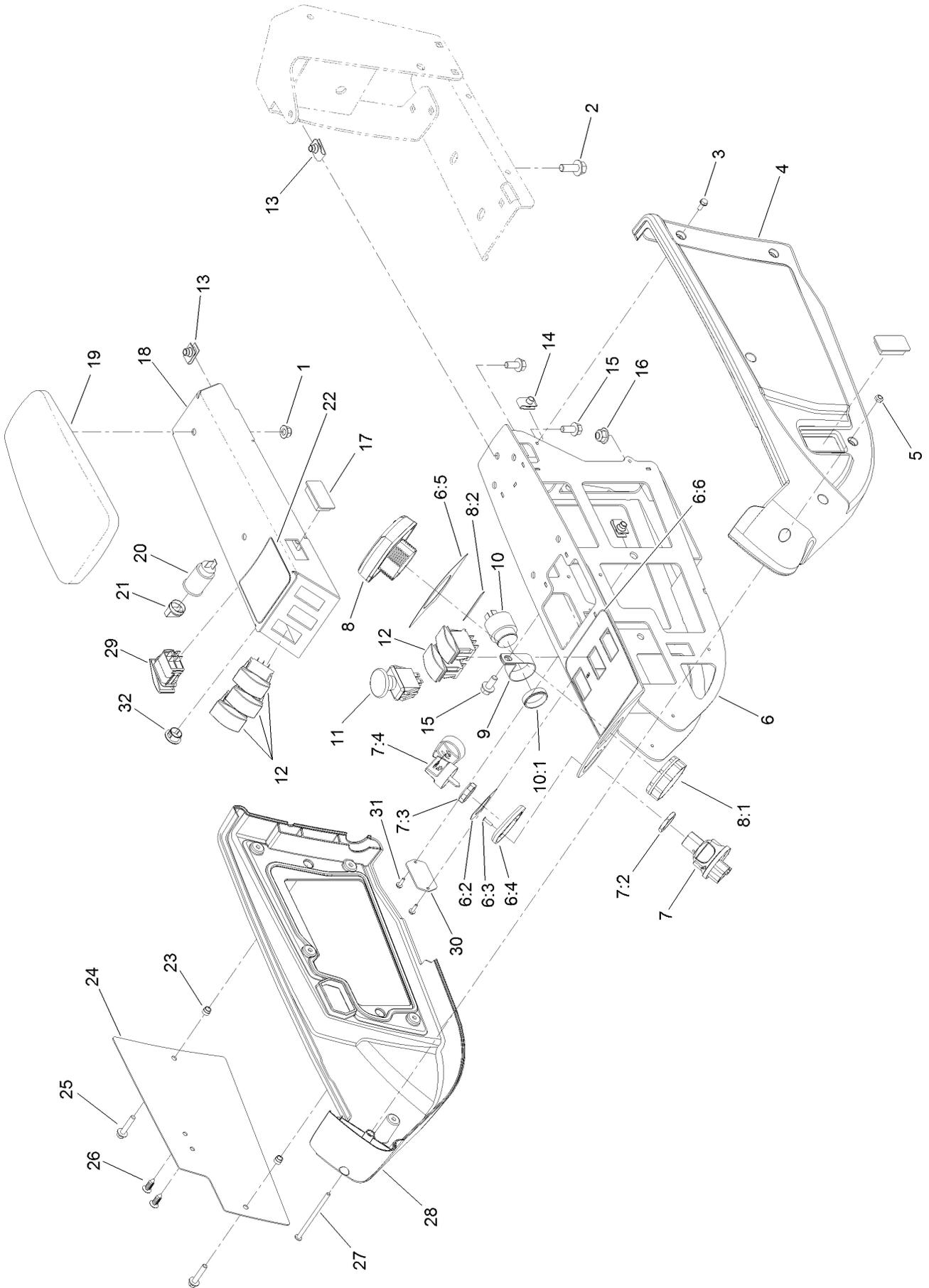

Armrest Control Panel Assembly (continued)

<i>Ref.</i>	<i>Part Number</i>	<i>Qty.</i>	<i>Description</i>	<i>Ref.</i>	<i>Part Number</i>	<i>Qty.</i>	<i>Description</i>
1	104-8300	2	Nut-HF, NI	12	100-1535	5	Switch-Rocker, (On)-Off-(On)
2	3234-42	2	Screw-HHF	13	94-2413	6	Nut-U
3	32144-112	10	Screw-HWH	14	107069	2	Clip
4	108-7604	1	Cover-LH	15	3234-5	6	Screw-HHF
5	3296-12	1	Nut-Lock, NI	16	104-8301	2	Nut-HF, NI
6	120-4155	1	Panel ASM	17	99-7420	2	Plug-Hole
6:2	121-3884	1	Decal-Console, Upper	18	136-4389-03	1	Panel-Control
6:3	3269-17	2	Rivet-Pop	19	108-7602	1	Rest-Arm
6:4	121-3889	1	Step-Elevated, Switch	20	99-7411	1	Point-Power
6:5	121-3887	1	Decal-Console, Display	21	99-7416	1	Cap
6:6	120-4159	1	Decal-Console, Lower	22	127-3700	1	Decal-Lift
7	121-5159	1	Switch-Ignition	23	110-0542	2	Spacer-Flange
7:2	121-5160	1	Nut-Hex	24	115-8849-03	1	Plate-Cover
7:3	121-5161	1	Nut-Face	25	3234-21	2	Screw-HHF
7:4	121-5162	1	Set-Key, Ignition	26	114-4899	2	Rivet-Push
8	120-6310	1	LCD Display ASM Kantrak 1700	27	3250-22	1	Screw-PPH
8:1	120-4630	1	Nut-Display	28	108-7605	1	Cover-RH
8:2	120-6311	1	Decal-Display	29	114-3329	1	Switch-Rocker
9	2412-74	1	R-Clamp	30	121-1630	1	Plate-Cover
10	80-9330	1	Audio Alarm ASM	31	32144-18	2	Screw-HWH
10:1	104-5107	1	Nut-Plastic, Knurled	32	94-5627	1	Plug
11	93-9999	1	Switch-PTO				

Cab, Tool Box and Flooring Assembly

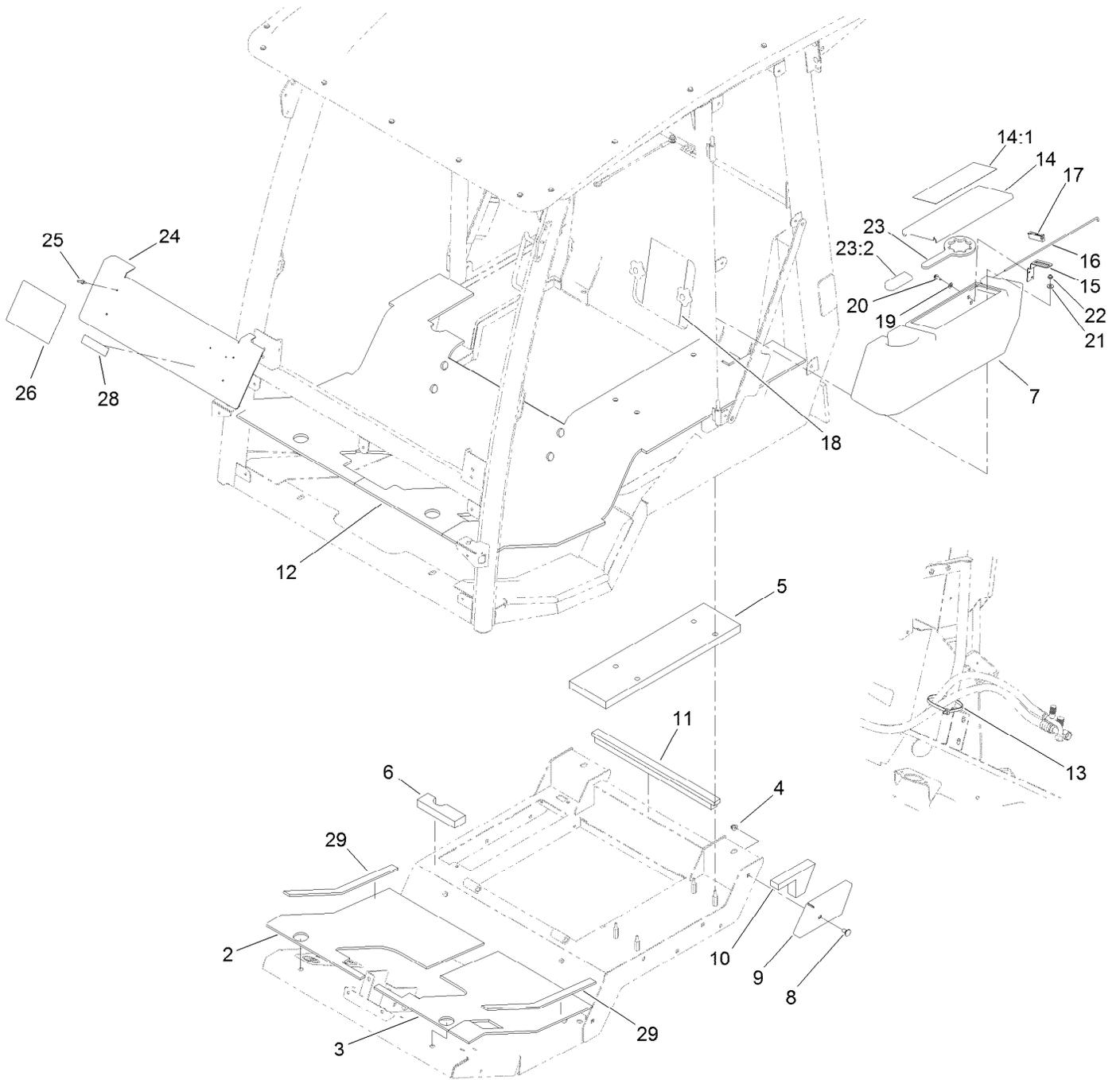

Cab, Tool Box and Flooring Assembly (continued)

<i>Ref.</i>	<i>Part Number</i>	<i>Qty.</i>	<i>Description</i>	<i>Ref.</i>	<i>Part Number</i>	<i>Qty.</i>	<i>Description</i>
2	136-2167	1	Tread-Floor, RH	16	120-4122	1	Rod-Hinge
3	136-2166	1	Tread-Floor, LH	17	58-4250	1	Catch-Magnetic
4	104-8301	1	Nut-HF, NI	18	137-5497	1	Decal-Service
5	136-2124	1	Foam-Fill, LH	19	3256-22	2	Washer-Flat
6	136-2125	1	Foam-Fill, RH	20	32104-95	2	Screw-HWH
7	120-4125	1	Housing-Tool Box	21	3256-2	4	Washer-Flat
8	3231-1	1	Screw-CARR	22	104-7201	4	Nut-HF, NI
9	130-5747-03	1	Cover-Mount	23	121-3874	1	Wrench ASM
10	127-9861	1	Foam-Corner	23:2	119-1846	1	Grip
11	121-8548	1	Foam-Seal, Rear	24	136-2123-03	1	Plate-Decal
12	136-2122	1	Tread-Floor	25	3269-22	4	Rivet-Pop
13	3334-945	1	Tie-Cable	26	114-0846	1	Decal-Instructions, Operating
14	120-4124	1	Tool Box Cover ASM	28	133-8062	1	Decal-Spark Arrestor
14:1	117-2754	1	Decal-Warning	29	136-2165	2	Tread-Floor, Edge
15	104-7545	1	Bracket-Latch				

Frame, Mount and Seal Assembly

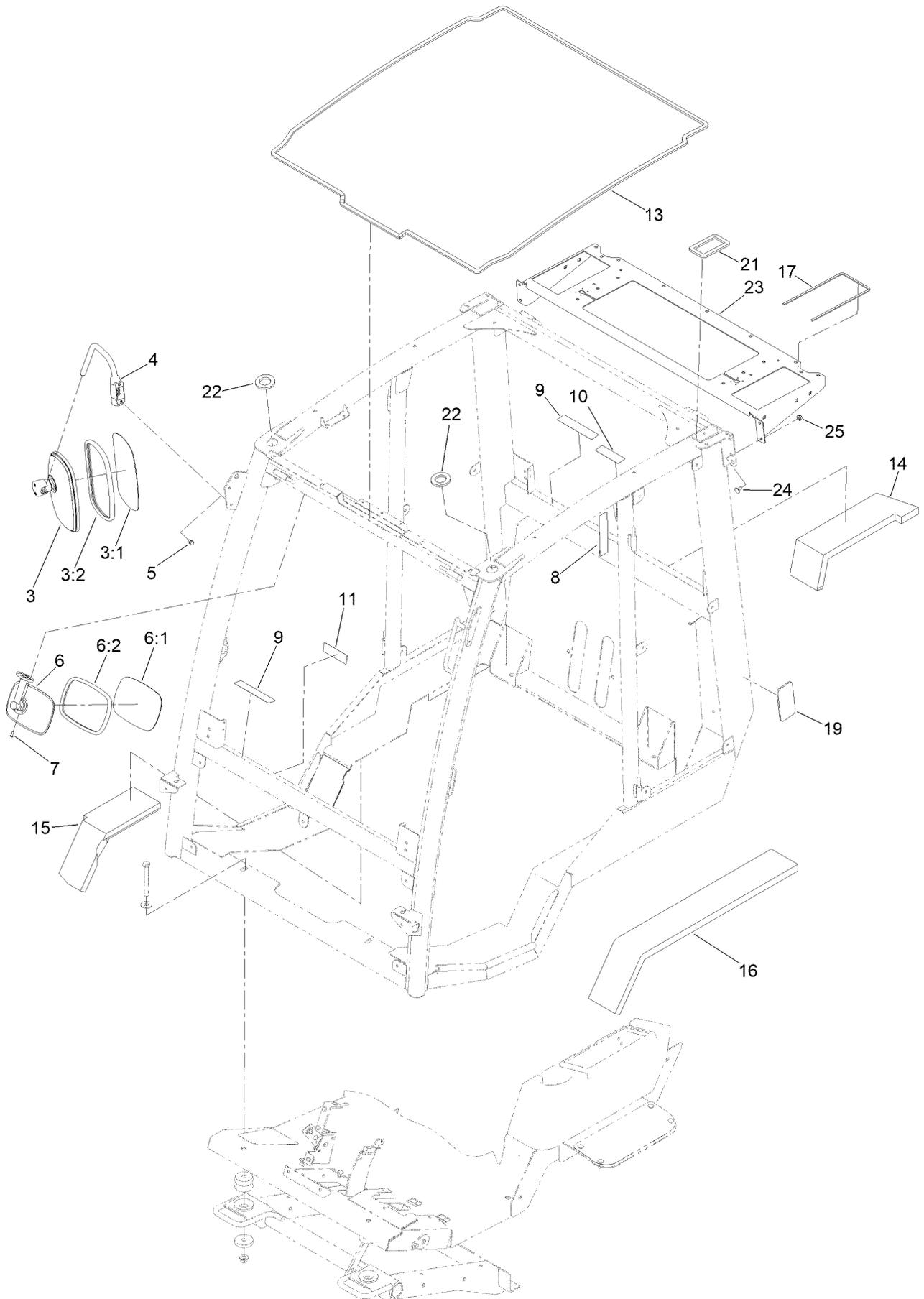

Frame, Mount and Seal Assembly (continued)

<i>Ref.</i>	<i>Part Number</i>	<i>Qty.</i>	<i>Description</i>	<i>Ref.</i>	<i>Part Number</i>	<i>Qty.</i>	<i>Description</i>
3	121-8341	2	Side Mirror ASM	11	130-5356	1	Decal-Traction Pedal
3:1		1	Mirror-Glass ●	13	130-0586	1	Seal-Foam, Frame Roof
3:2		1	Gasket ●	14	121-8545	1	Seal-Foam, RH-Upper
4	121-8275	2	Arm-Mirror, Side	15	121-8546	1	Seal-Foam, RH
5	33103-016	4	Screw-HHF	16	136-2182	1	Foam-Seal, LH
6	121-8343	1	Interior Mirror ASM	17	130-0587	2	Seal-Foam, Roof Air Filter
6:1		1	Mirror ●	19	130-5923	2	Pad
6:2		1	Gasket ●	21	130-5855	2	Seal-Tube, Rear
7	32144-32	2	Screw-PPH	22	133-0982	2	Tube-Seal, Front
8	130-0594	1	Decal-Warning	23	136-1768-03	1	Shelf-Mount, Fan
9	130-0611	4	Decal-Window, Pin	24	3230-18	4	Screw-CARR
10	130-5355	1	Decal-Window, Hood	25	104-8300	4	Nut-HF, NI

● Not serviced separately

Cab Headliner Assembly

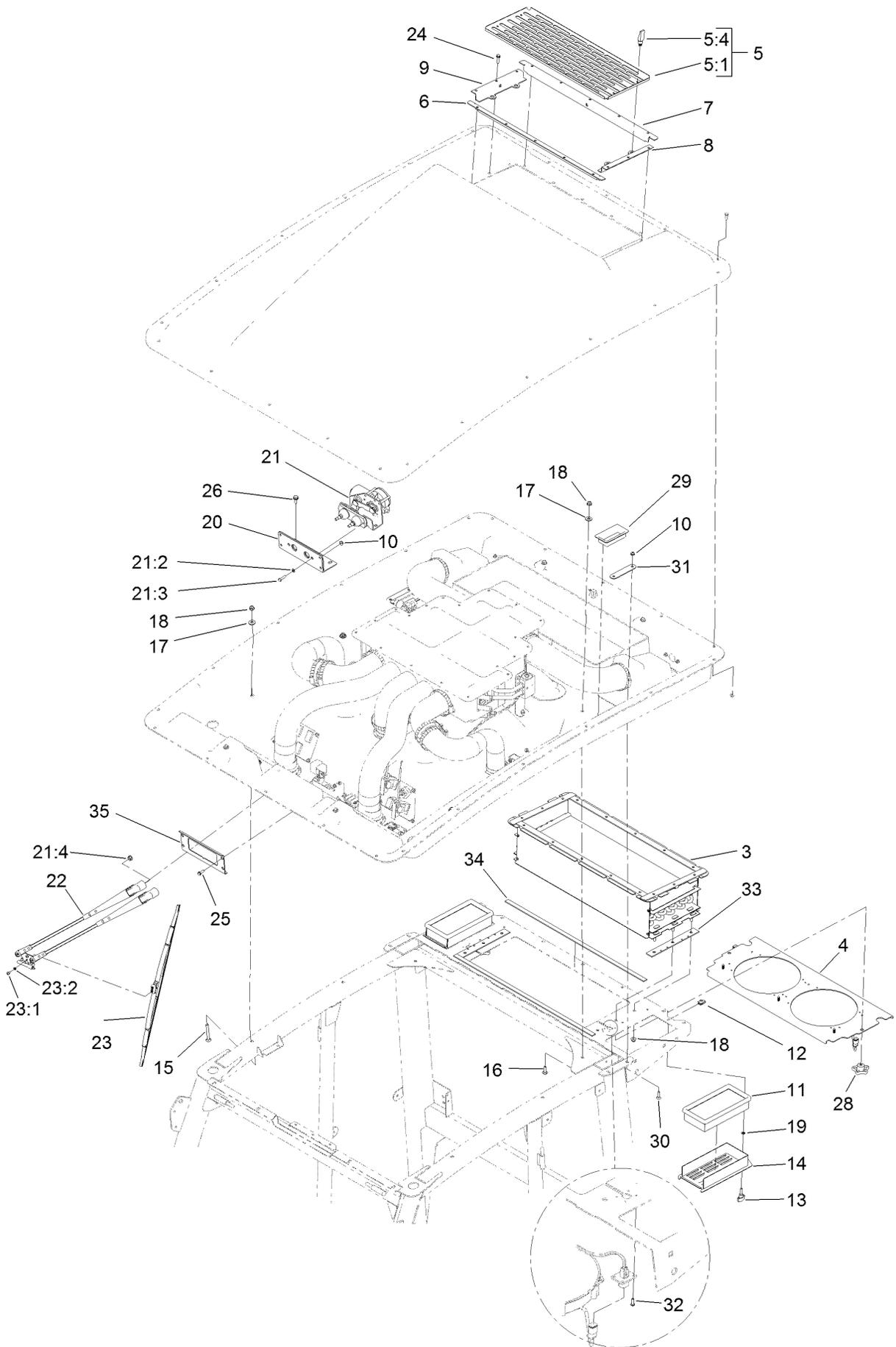

Cab Headliner Assembly (continued)

<i>Ref.</i>	<i>Part Number</i>	<i>Qty.</i>	<i>Description</i>	<i>Ref.</i>	<i>Part Number</i>	<i>Qty.</i>	<i>Description</i>
3	132-3468	1	A/C Duct ASM	21	125-7452	1	Wiper Motor ASM
4	132-3488	1	Panel-Fan	21:2	3253-3	1	Washer-Lock
5		1	Screen ASM ●	21:3	33113-025	1	Screw-HH
5:1	132-3530-03	1	Screen	21:4	112-2844	2	Nut-HF
5:4	74-5950	4	Latch-Swell	22	125-7453	1	Arm-Wiper
6	132-3531-03	1	Seal-Front	23	125-7454	1	Blade-Wiper
7	132-3532-03	1	Seal-Rear	23:1	47-2830	2	Screw
8	132-3533-03	1	Seal-Side, Left	23:2	43-5920	2	Washer-Lock, Spring
9	132-3534-03	1	Seal-Side, Right	24	120-4654	16	Screw-HHF
10	104-7201	8	Nut-HF, NI	25	32105-15	4	Screw-HWH
11	121-8457	2	Filter-Air	26	32144-11	2	Screw-HWH
12	107069	2	Clip	28	117-5976	2	Knob-Handle
13	126-5846	2	Knob-T	29	130-5661	2	Tube-Sleeve
14	125-9825-03	2	Cover-Air, Fresh	30	3229-30	4	Screw-CARR
15	3230-9	4	Screw-CARR	31	130-5854	2	Brace-Seal
16	3230-22	13	Screw-CARR	32	363-8245	8	Screw-TAP
17	3256-3	17	Washer-Flat	33	132-3608	2	Seal-Edge
18	104-8300	21	Nut-HF, NI	34	132-3609	2	Seal-Strip
19	106-8737	2	Nut-Retainer	35	130-6068-03	1	Plate-Washer, Wiper Motor
20	130-5871	1	Bracket-Wiper				

● Not serviced separately

Air Conditioning Duct Assembly No. 132-3468

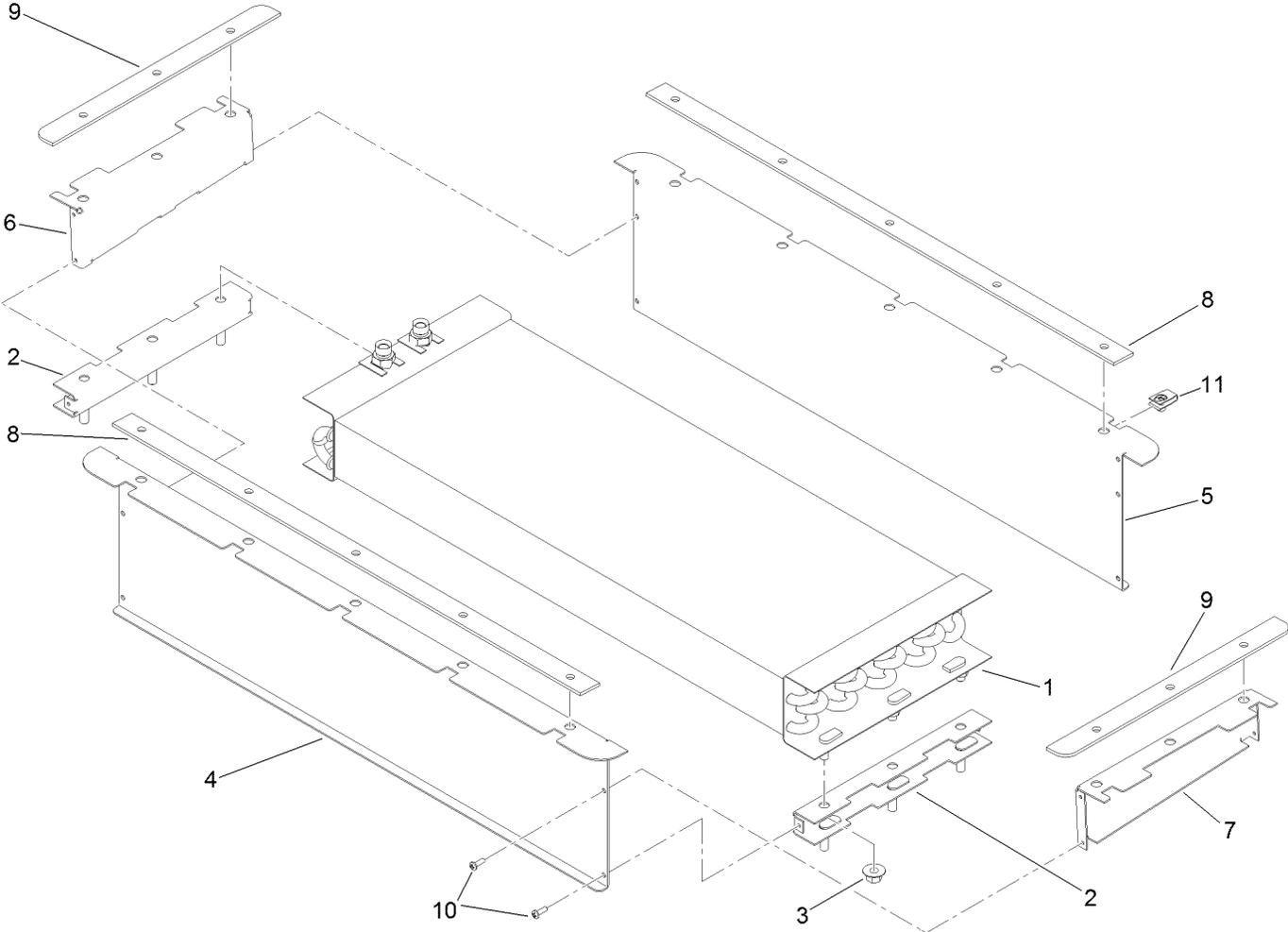

Air Conditioning Duct Assembly No. 132-3468 (continued)

<i>Ref.</i>	<i>Part Number</i>	<i>Qty.</i>	<i>Description</i>	<i>Ref.</i>	<i>Part Number</i>	<i>Qty.</i>	<i>Description</i>
1	121-8447	1	Core-Condenser	7	132-3465-03	1	Wall-Side, Left
2	132-3469-03	2	Leg-Lower	8	132-3466	2	Seal-Strip
3	32128-44	6	Nut	9	132-3467	2	Seal-Edge
4	132-3462-03	1	Wall-Front	10	363-8245	12	Screw-TAP
5	132-3463-03	1	Wall-Back	11	107069	16	Clip
6	132-3464-03	1	Wall-Side, Right				

Fan Panel Assembly No. 132-3488

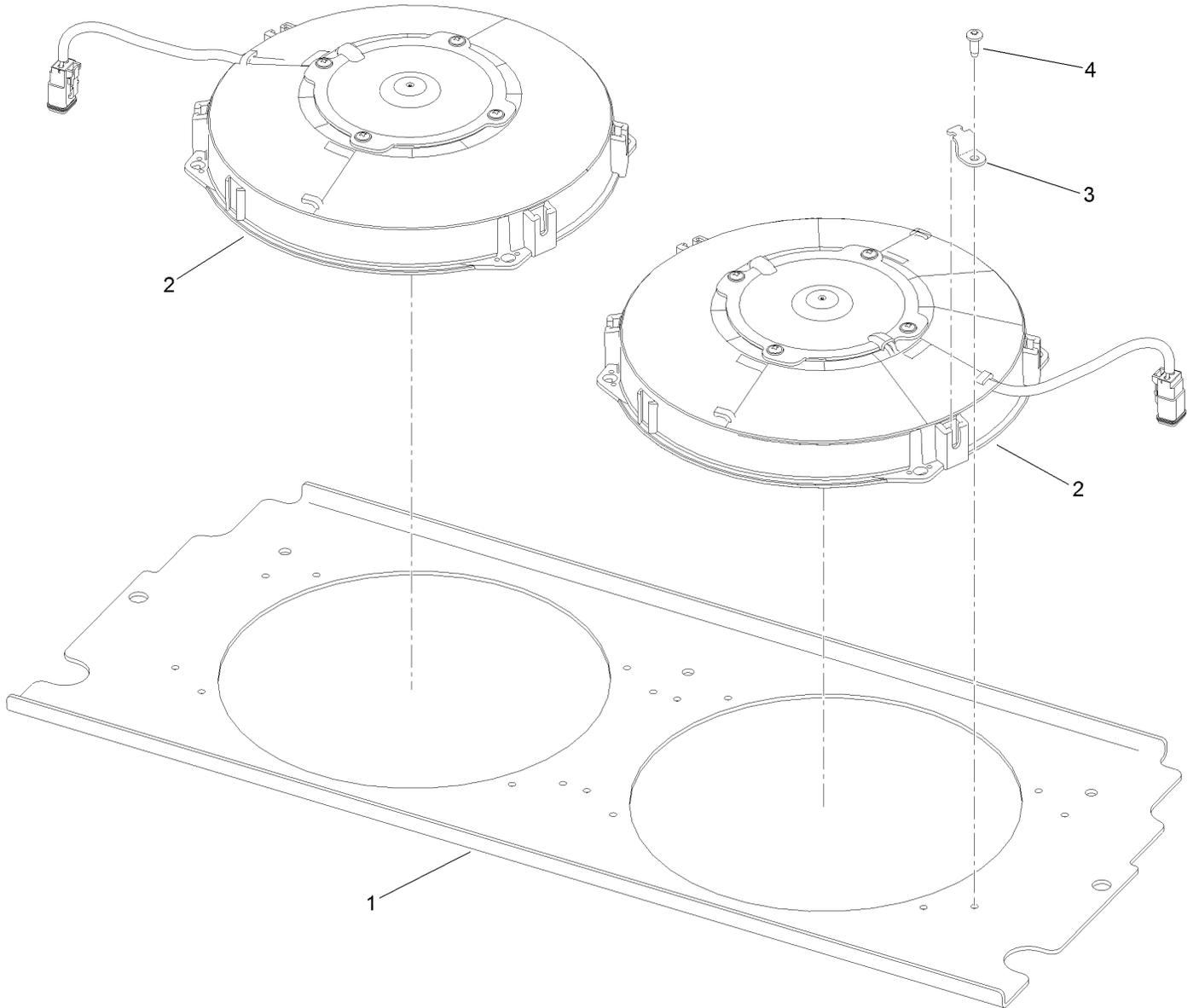

Fan Panel Assembly No. 132-3488 (continued)

<i>Ref.</i>	<i>Part Number</i>	<i>Qty.</i>	<i>Description</i>	<i>Ref.</i>	<i>Part Number</i>	<i>Qty.</i>	<i>Description</i>
1	132-3486-03	1	Plate-Mount, Fan	3	132-3606	8	Tab-Fan
2	132-3607	2	Fan-Condenser	4	105-6849	8	Screw-Forming, Thread

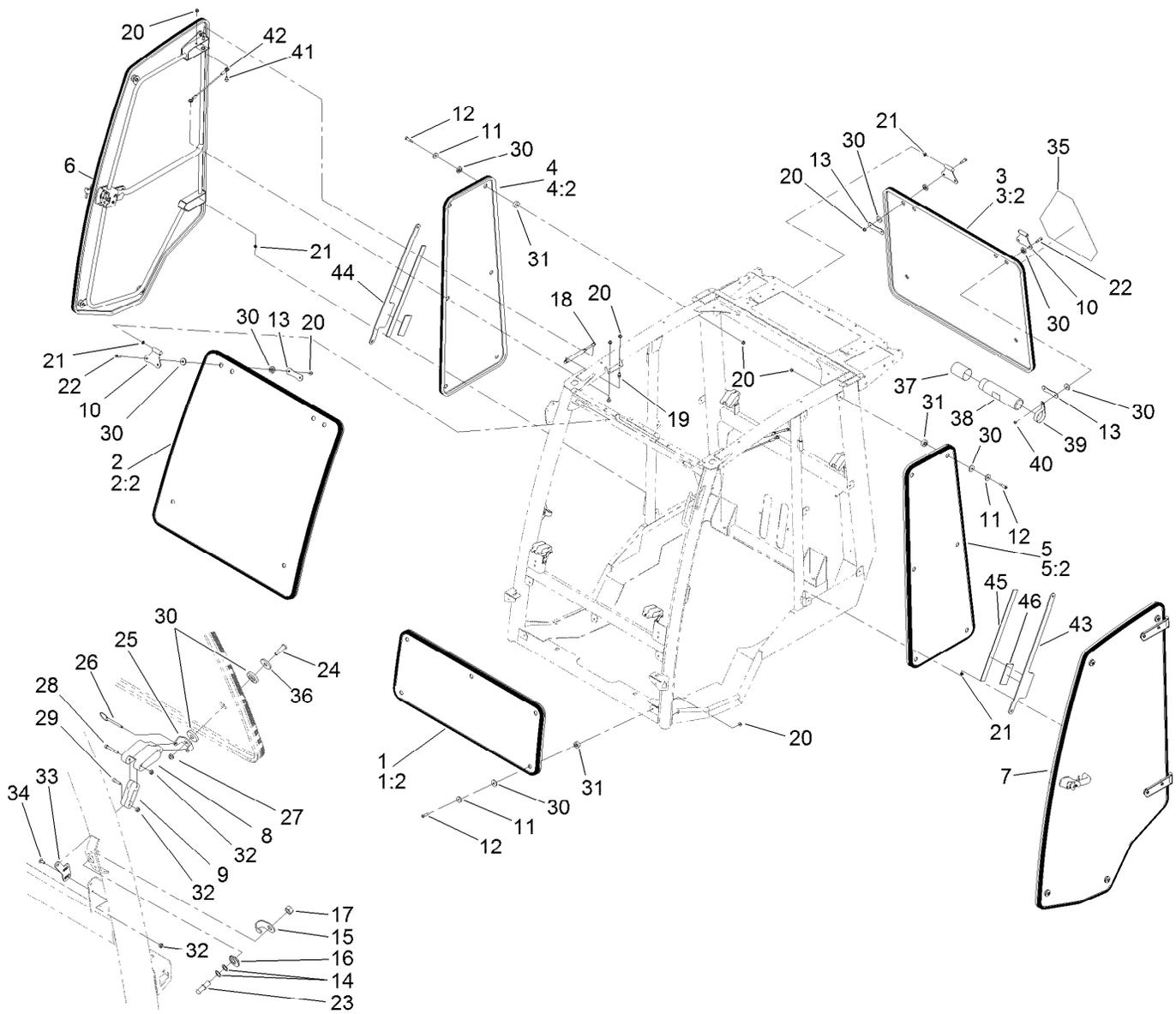

Window, Door and Striker Assembly

Ref.	Part Number	Qty.	Description
1	130-5681	1	Lower Front Window ASM
1:2	121-8211	1	Trim-Window, Front
2	130-5680	1	Upper Front Window ASM
2:2	121-8212	1	Seal-Trim
3	130-5682	1	Rear Window ASM
3:2	130-0637	1	Seal-Trim
4	130-5676	1	RH-Side Window ASM
4:2	121-8215	1	Seal-Trim
5	130-5677	1	LH-Side Window ASM
5:2	121-8215	1	Seal-Trim
6		1	RH Door ASM ■
7		1	LH Door ASM ■
8	125-9792	4	Handle-Window
9	125-9793	4	Link-Window
10	121-8535-03	4	Hinge-Window
11	130-5815	13	Washer-Backup
12	125-9521	17	Screw-Shldr HSH
13	127-9933	4	Plate-Backer, Windshield

Ref.	Part Number	Qty.	Description
14	73-0040	2	Washer-Thrust
15	121-8393	2	Guard-Striker
16	125-9992	2	Adjuster-Stud
17	106-0327	2	Nut-Hex
18	130-6083	2	Spring-Gas, Door
19	98-3104	2	Stud-Ball
20	104-8300	29	Nut-HF, NI
21	121-8441	8	Washer-Spacer
22	125-9520	8	Screw-Shoulder, HSH
23	125-9993	2	Striker-Stud
24	119-9812	4	Bolt-Shoulder
25	125-9987	4	Mount-Latch
26	127-9850	4	Pin-Release, Quick
27	104-7201	4	Nut-HF, NI
28	3274-59	4	Screw-HSH
29	3274-14	4	Screw-HSH
30	125-9982	41	Bushing-Flange
31	125-9537	17	Bushing-Flange

● Not illustrated

■ Not serviced separately

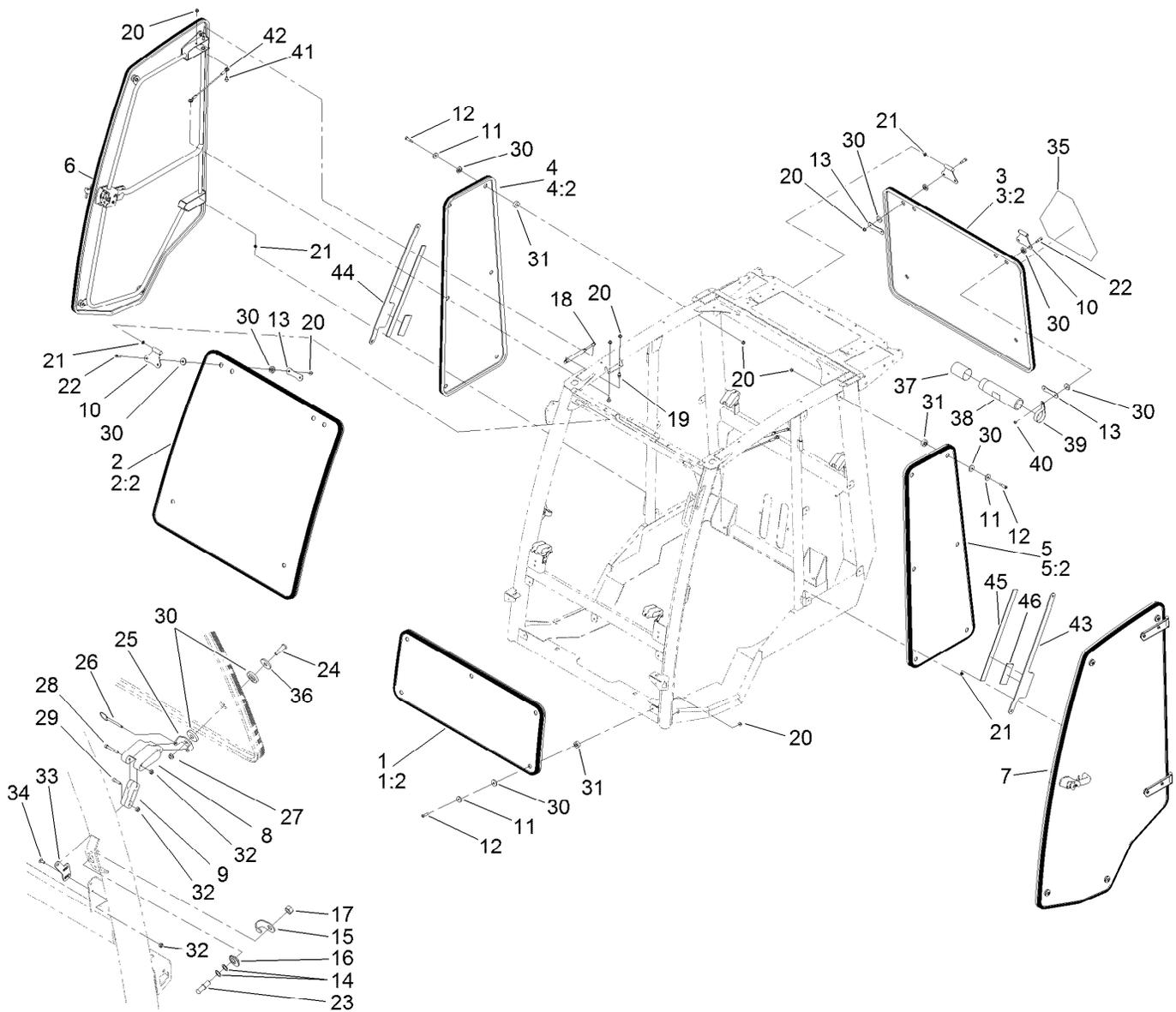

Window, Door and Striker Assembly (continued)

Ref.	Part Number	Qty.	Description	Ref.	Part Number	Qty.	Description
32	120-9681	16	Nut-Lock, NI	41	120-9471	4	Bolt-Shoulder
33	130-0590	4	Mount-Tab	42	130-5726	2	Lanyard
34	1-807513	8	Bolt-CARR	43	130-6095-03	1	Strap-Support, Left
35	120-0250	1	Decal-Warning	44	130-6091-03	1	Strap-Support
36	125-9676	4	Washer-Backup	45	130-6096	2	Strap-Foam, 19.5 Inch
37	104-7048	1	Cap-Housing	46	130-6097	2	Strap-Foam, 4.25 Inch
38	104-7050	1	Tube-Manual	48	133-1110	1	Pin-Hinge ●
39	2412-133	2	Clamp-R	49	121-8439	1	Receiver-Pivot, Hinge ●
40	3296-47	2	Nut-Lock,NI	50	121-4880	1	Bracket-Mount, Cable ●

● Not illustrated

■ Not serviced separately

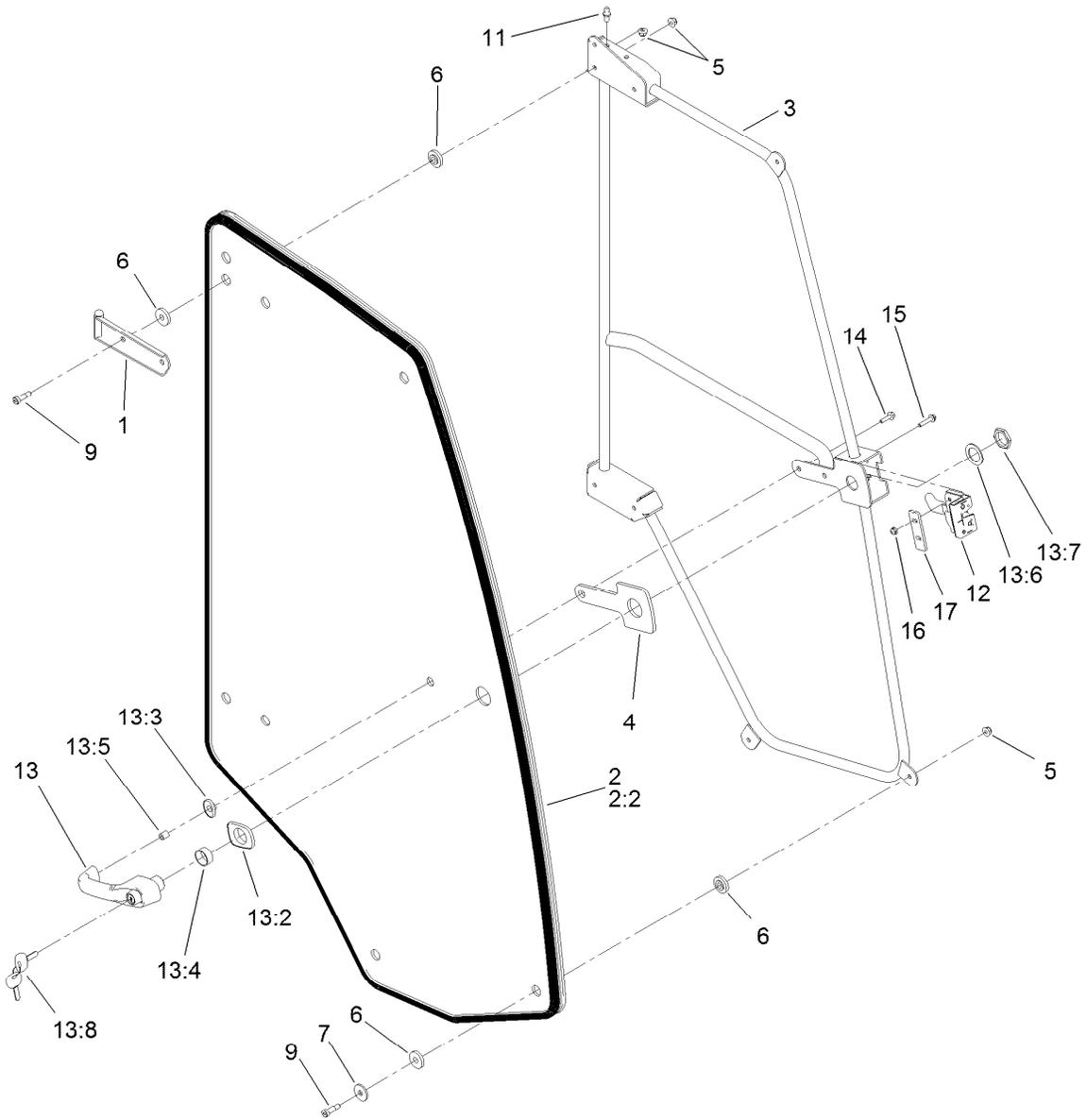

RH Door Assembly

<i>Ref.</i>	<i>Part Number</i>	<i>Qty.</i>	<i>Description</i>	<i>Ref.</i>	<i>Part Number</i>	<i>Qty.</i>	<i>Description</i>
1	125-9618-03	2	Hinge-Door, RH	13:2	121-8628	1	Cylinder-Mounting, Key
2	130-5678	1	RH Door ASM	13:3	121-8322	1	Grommet-Mounting, Large
2:2	125-9799	1	Trim-Door	13:4	121-8327	1	Washer
3	121-8570-03	1	Frame-Door, RH	13:5	121-8328	1	Nut
4	121-8331	1	Gasket-Handle	13:6	121-8627	1	Cylinder-Mounting, End
5	104-8300	9	Nut-HF, NI	13:7	121-8323	1	Grommet-Mounting, Small
6	125-9982	16	Bushing-Flange	13:8	125-9531	1	Key-Set
7	125-9676	4	Washer-Backup	14	33103-025	1	Screw-HHF
9	125-9520	8	Screw-Shoulder, HSH	15	3234-21	2	Screw-HHF
11	98-3104	1	Stud-Ball	16	104-7201	2	Nut-HF, NI
12	121-8390	1	Latch-RH	17	121-8395	1	Plate-Support, Latch
13	121-8630	1	Handle ASM				

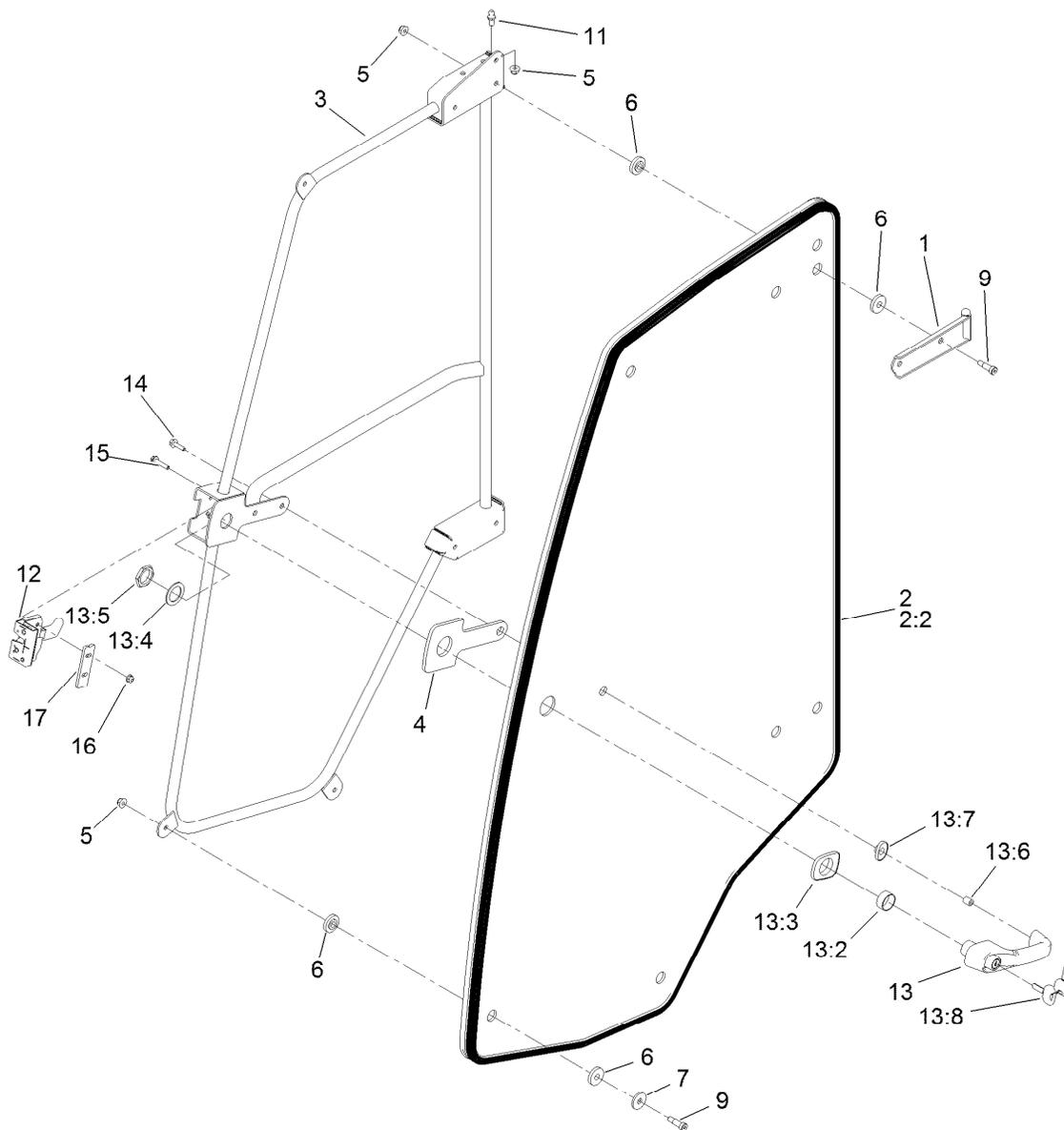

LH Door Assembly

<i>Ref.</i>	<i>Part Number</i>	<i>Qty.</i>	<i>Description</i>	<i>Ref.</i>	<i>Part Number</i>	<i>Qty.</i>	<i>Description</i>
1	125-9619-03	2	Hinge-Door, LH	13:2	121-8628	1	Cylinder-Mounting, Key
2	130-5679	1	LH Door ASM	13:3	121-8322	1	Grommet-Mounting, Large
2:2	121-8216	1	Trim-Window	13:4	121-8327	1	Washer
3	121-8571-03	1	Frame-Door, LH	13:5	121-8328	1	Nut
4	121-8331	1	Gasket-Handle	13:6	121-8627	1	Cylinder-Mounting, End
5	104-8300	9	Nut-HF, NI	13:7	121-8323	1	Grommet-Mounting, Small
6	125-9982	16	Bushing-Flange	13:8	125-9531	1	Key-Set
7	125-9676	4	Washer-Backup	14	33103-025	1	Screw-HHF
9	125-9520	8	Screw-Shoulder, HSH	15	3234-21	2	Screw-HHF
11	98-3104	1	Stud-Ball	16	104-7201	2	Nut-HF, NI
12	121-8391	1	Latch-LH	17	121-8395	1	Plate-Support, Latch
13	121-8630	1	Handle ASM				

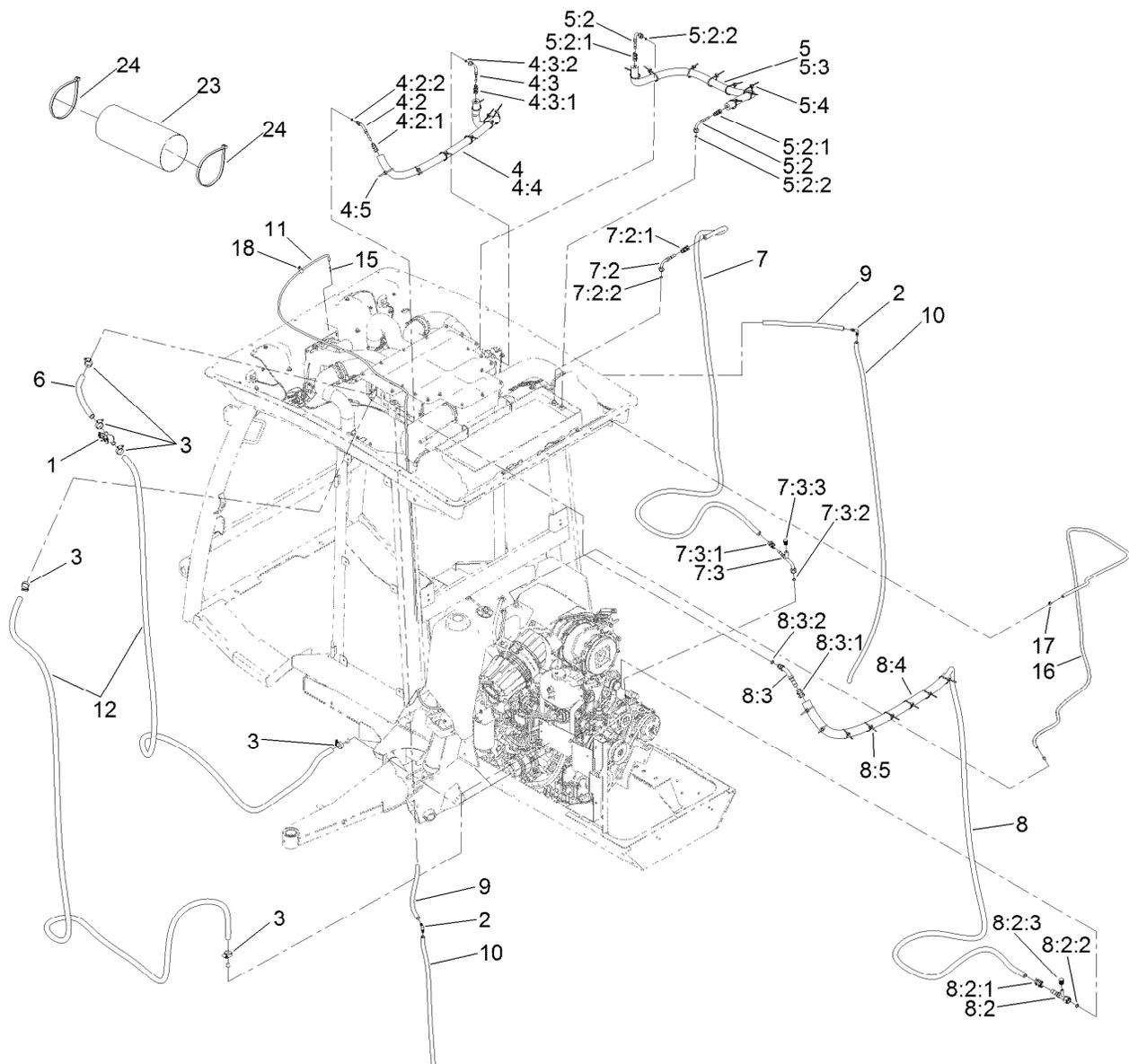

Engine Hose Routing Assembly

Ref.	Part Number	Qty.	Description	Ref.	Part Number	Qty.	Description
1	120-4947	1	Valve-Heater	7:2:1	130-5773	1	Fitting Kit
2	130-0578	2	Fitting-Barb, 90 DEG	7:2:2	117-2778	1	O-Ring
3	2412-129	6	Clamp-Hose	7:3	130-5758	1	Fitting-Female, 90 DEG
4	125-9702	1	Hose ASM	7:3:1	130-5773	1	Fitting Kit
4:2	130-5753	1	Fitting-45 DEG	7:3:2	117-2779	1	O-Ring
4:2:1	130-5772	1	Fitting Kit	7:3:3	117-2783	1	Cap-Side, High
4:2:2	117-2778	1	O-Ring	8	125-9862	1	Hose ASM
4:3	130-5751	1	Fitting-Female, 90 DEG	8:2	130-5755	1	Fitting-Female, Straight
4:3:1	130-5772	1	Fitting Kit	8:2:1	130-5775	1	Fitting Kit
4:3:2	117-2778	1	O-Ring	8:2:2	117-2780	1	O-Ring
4:4	130-5958	1	Cover-Foam	8:2:3	117-2784	1	Cap-Side, Low
4:5	3290-378	8	Tie-Cable	8:3	130-5754	1	Fitting-Male, 45 DEG
5	125-9703	1	Hose ASM	8:3:1	130-5775	1	Fitting Kit
5:2	130-5751	2	Fitting-Female, 90 DEG	8:3:2	117-2780	1	O-Ring
5:2:1	130-5772	1	Fitting Kit	8:4	130-5959	1	Cover-Foam
5:2:2	117-2778	1	O-Ring	8:5	3290-378	16	Tie-Cable
5:3	130-5958	1	Cover-Foam	9	125-9865	2	Hose-Drain
5:4	3290-378	8	Tie-Cable	10	125-9866	2	Hose-Drain
6	125-9706	1	Hose-Heater	11	127-9901	1	Hose-Washer Fluid
7	125-9861	1	Hose ASM	12	125-9864	2	Hose-Heater
7:2	130-5752	1	Fitting-Female, 90 DEG	15	127-9905	1	Fitting-Hose, Barb

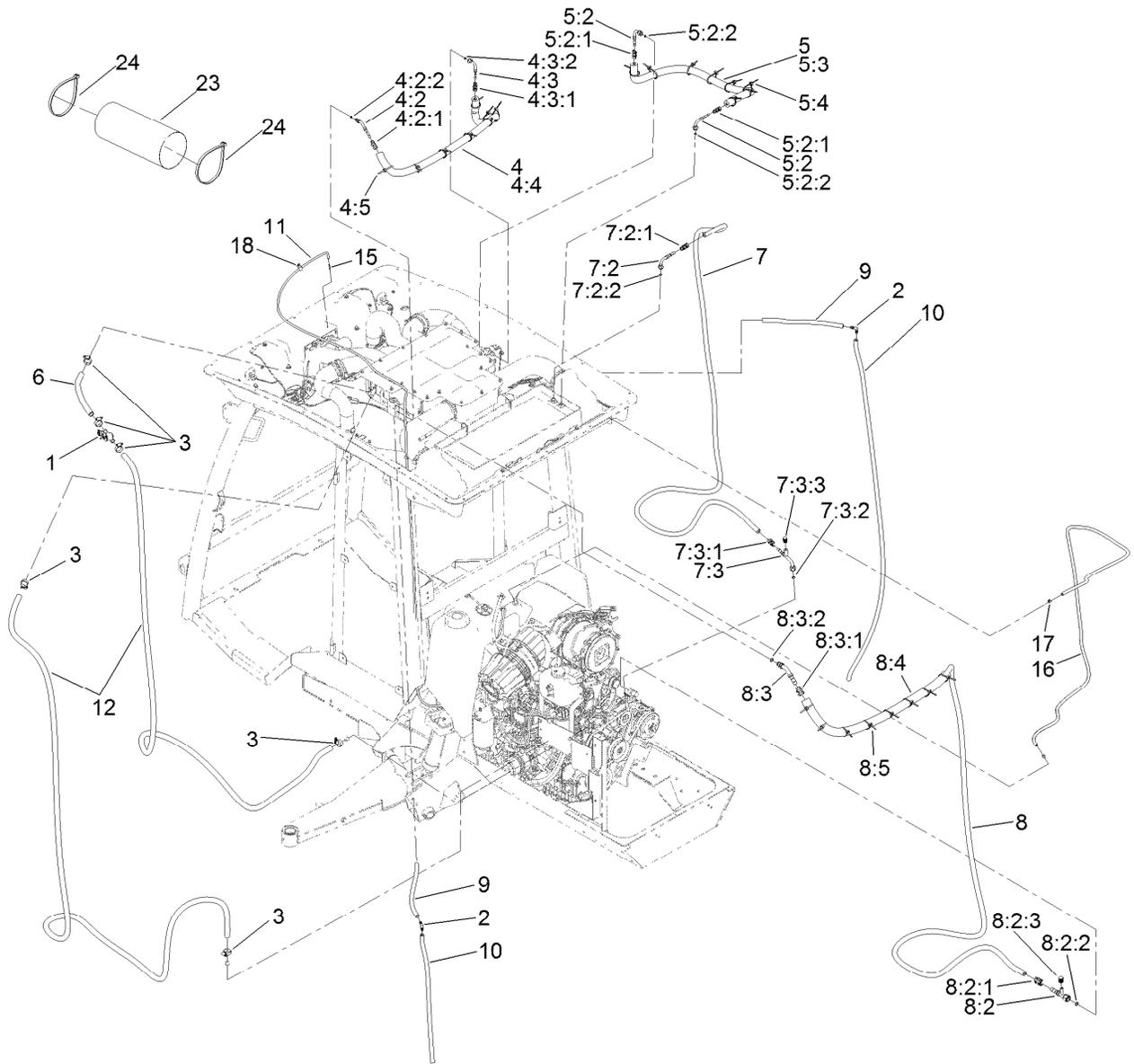

Engine Hose Routing Assembly (continued)

Ref.	Part Number	Qty.	Description
16	130-5813	1	Hose-Fuel
17	2412-98	1	Clamp-Hose
18	2412-73	1	Clamp-R

Ref.	Part Number	Qty.	Description
23	133-1025	1	Wrap-Abrasion
24	94-3890	2	Tie-Cable

Pre-Filter Screen Assembly

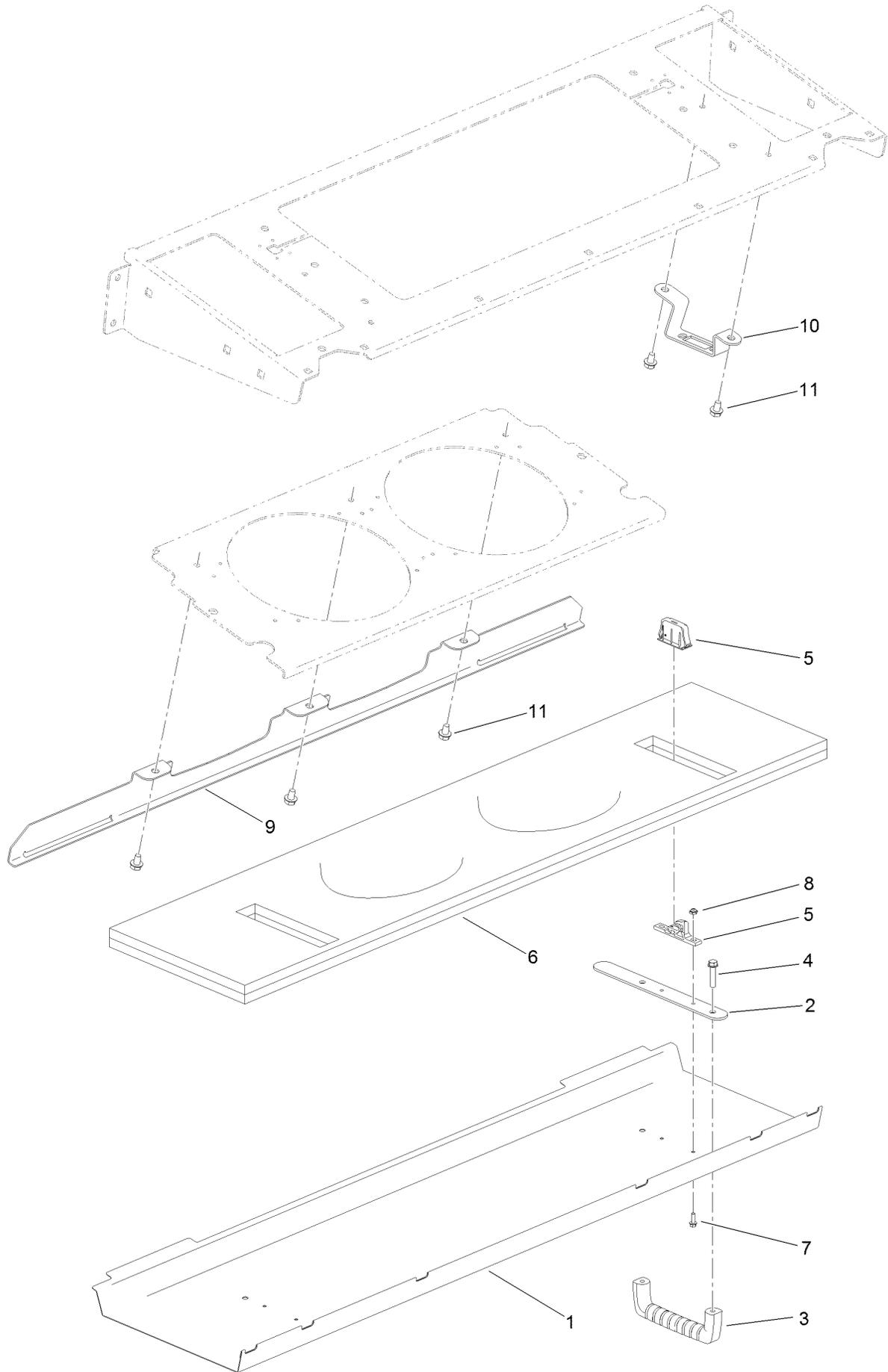

Pre-Filter Screen Assembly (continued)

<i>Ref.</i>	<i>Part Number</i>	<i>Qty.</i>	<i>Description</i>	<i>Ref.</i>	<i>Part Number</i>	<i>Qty.</i>	<i>Description</i>
1	130-0640-03	1	Screen	7	112-3169	4	Screw-HHF, Serrated
2	130-0642-03	2	Backplate	8	3296-54	4	Nut-Lock
3	65-5100	2	Handle-Door	9	132-3630-03	1	Screen-Mount, Front
4	46-8092	4	Screw-Plastite	10	136-2171	2	Mount-Latch
5	130-0643	2	Latch-Push To Close	11	32104-82	7	Screw-HHF
6	130-5875	1	Pre-Filter				

Interior Foam Assembly

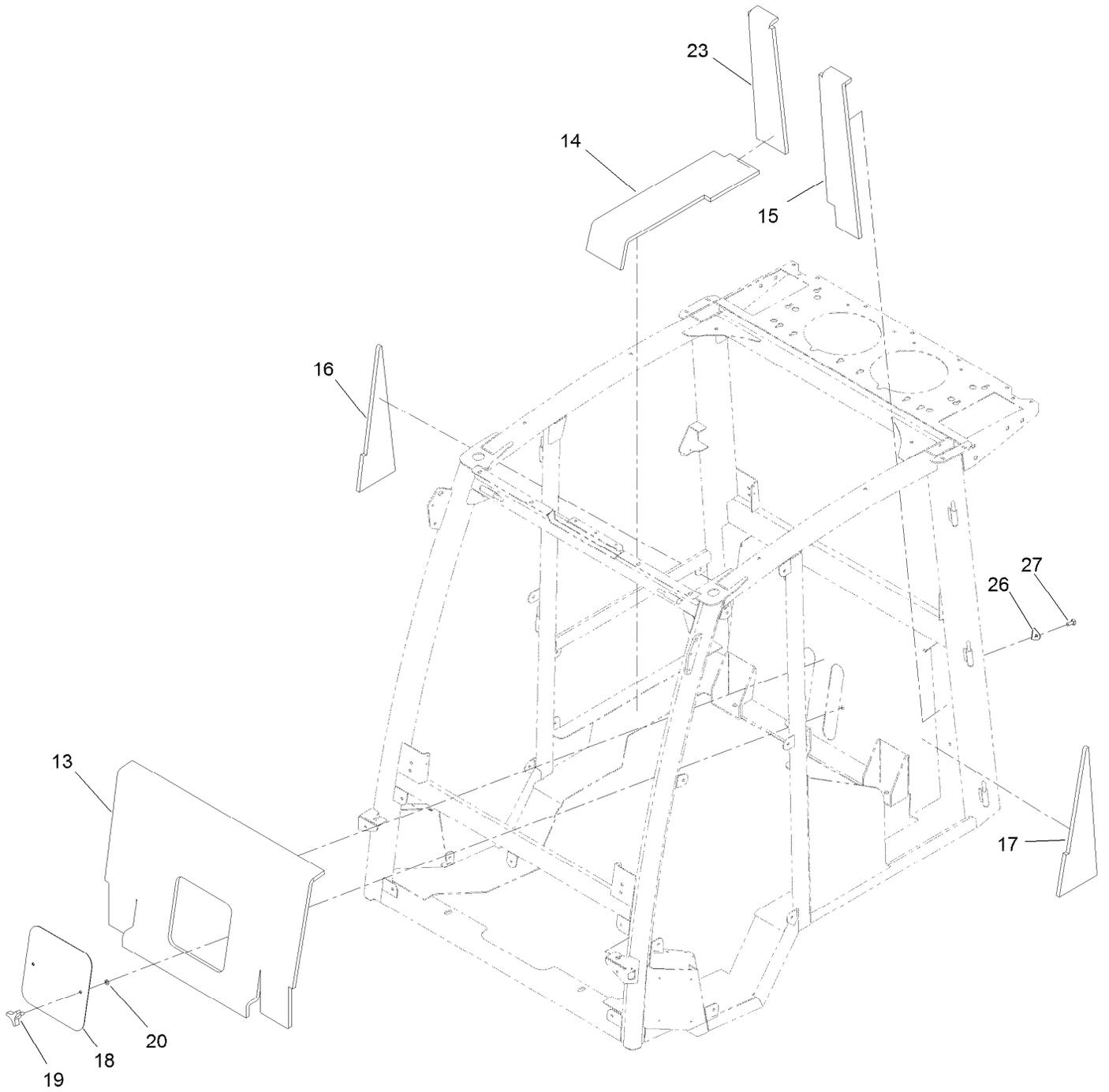

Interior Foam Assembly (continued)

<i>Ref.</i>	<i>Part Number</i>	<i>Qty.</i>	<i>Description</i>	<i>Ref.</i>	<i>Part Number</i>	<i>Qty.</i>	<i>Description</i>
13	130-0564	1	Foam-Upholstery, Rear	19	117-5976	2	Knob-Handle
14	136-2179	1	Foam-Interior, RH (Lower)	20	3296-47	2	Nut-Lock,NI
15	136-2178	1	Foam-Upholstery, Rear (LH)	23	130-5838	1	Foam-Interior, RH (Upper)
16	130-0561	1	Foam-Upholstery, Side (RH)	26	132-3495	2	Retainer-Cover
17	130-0570	1	Foam-Upholstery, Rear (LH)	27	3230-22	2	Screw-CARR
18	121-8161-03	1	Plate-Panel, Access				

Roof and Headliner Assembly

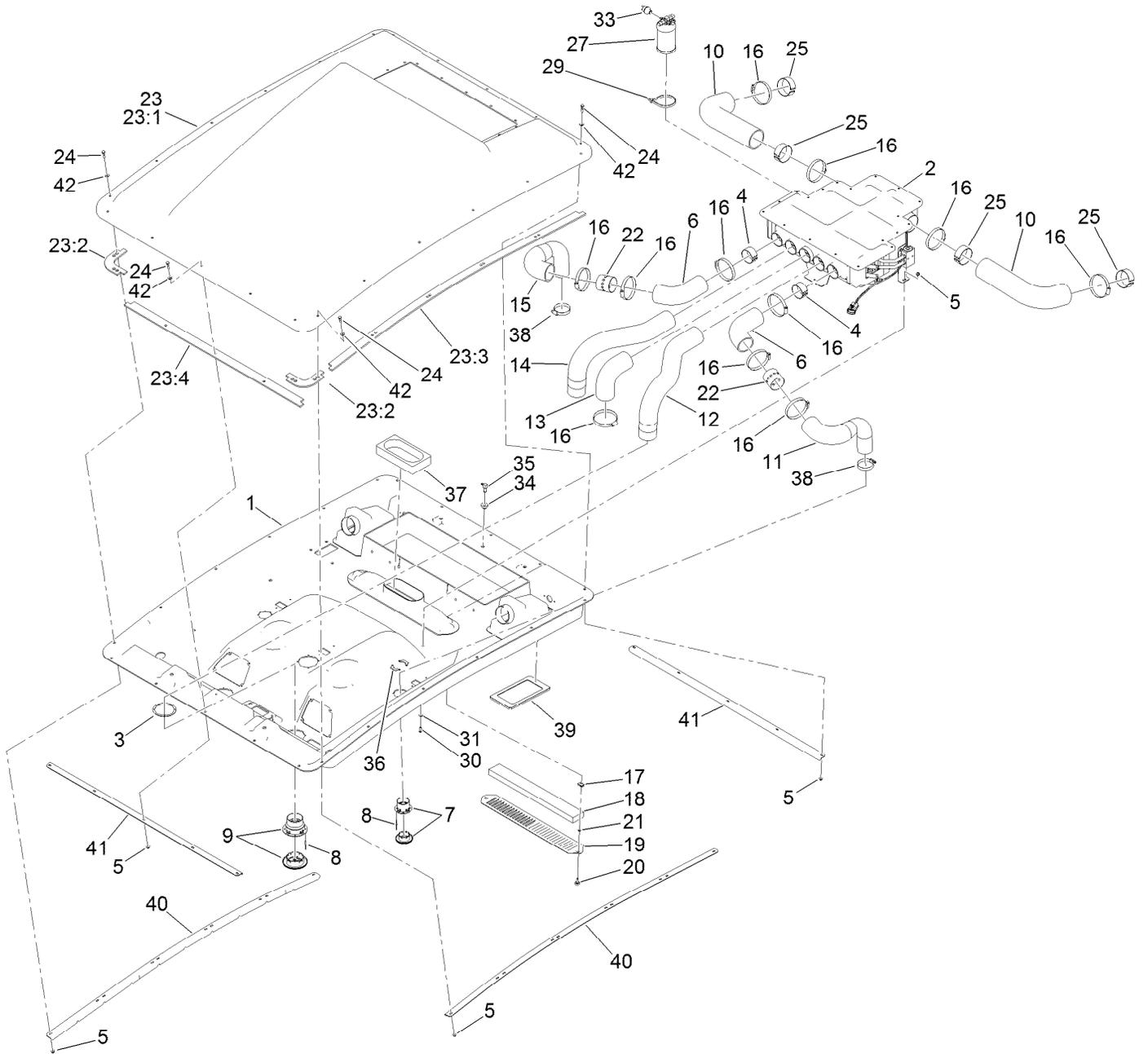

Roof and Headliner Assembly (continued)

<i>Ref.</i>	<i>Part Number</i>	<i>Qty.</i>	<i>Description</i>	<i>Ref.</i>	<i>Part Number</i>	<i>Qty.</i>	<i>Description</i>
1	121-8470	1	Headliner	22	130-5927	2	Adapter-Bleed
2	121-8495	1	Box-Mixing, Heater A/C	23	132-3601	1	Roof ASM
3	130-0558	3	Backplate-Rivet	23:1	132-3602	1	Roof
4	130-5938	2	Tube-Support	23:2	130-5961	4	Seal-Corner
5	104-7201	24	Nut-HF, NI	23:3	130-5960	2	Seal-Side
6	130-5860	2	Hose-Vent	23:4	130-5962	2	Seal-Front, Rear
7	130-0455	2	Louver-Round, Snap-In	24	136-8674	22	Bolt-Pivot, Eccentric
8	125-7503	20	Rivet-Pop	25	130-5939	4	Tube-Support
9	130-0465	3	Louver-Round, Snap-In (4 Inch)	27	130-5999	1	Drier-Receiver
10	121-8473	2	Hose-Intake, Fresh Air	29	3334-945	2	Tie-Cable
11	130-5861	1	Hose-Vent, Outer (LH)	30	3274-69	2	Screw-HSBH
12	121-8477	1	Hose-Vent, Defrost (LH)	31	3256-1	2	Washer-Flat
13	130-0437	1	Hose-Vent, Center	33	119-4501	1	Switch-Function, Dual
14	121-8478	1	Hose-Vent, Defrost (RH)	34	46-6560	1	Bushing
15	130-5862	1	Hose-Vent, Outer (RH)	35	104-5228	1	Fitting-Elbow, 90 DEG
16	2412-110	11	Clamp-Band/Screw	36	130-0445	4	Backplate-Rivet
17	107069	2	Clip	37	130-0444	1	Foam-Inlet, Airbox
18	125-9532	1	Filter-Cab, Inside	38	2412-130	2	Clamp-Hose
19	125-9604-03	1	Plate-Cover, Recirculation	39	132-3474	2	Insert-Seal, Filter
20	125-7438	2	Knob-Screw, Thumb	40	132-1461-03	2	Strap-Cab, Side
21	106-8737	2	Nut-Retainer	41	132-1462-03	2	Strap-Cab
				42	3256-74	22	Washer-Flat

Headliner Wire Harness and Control Assembly

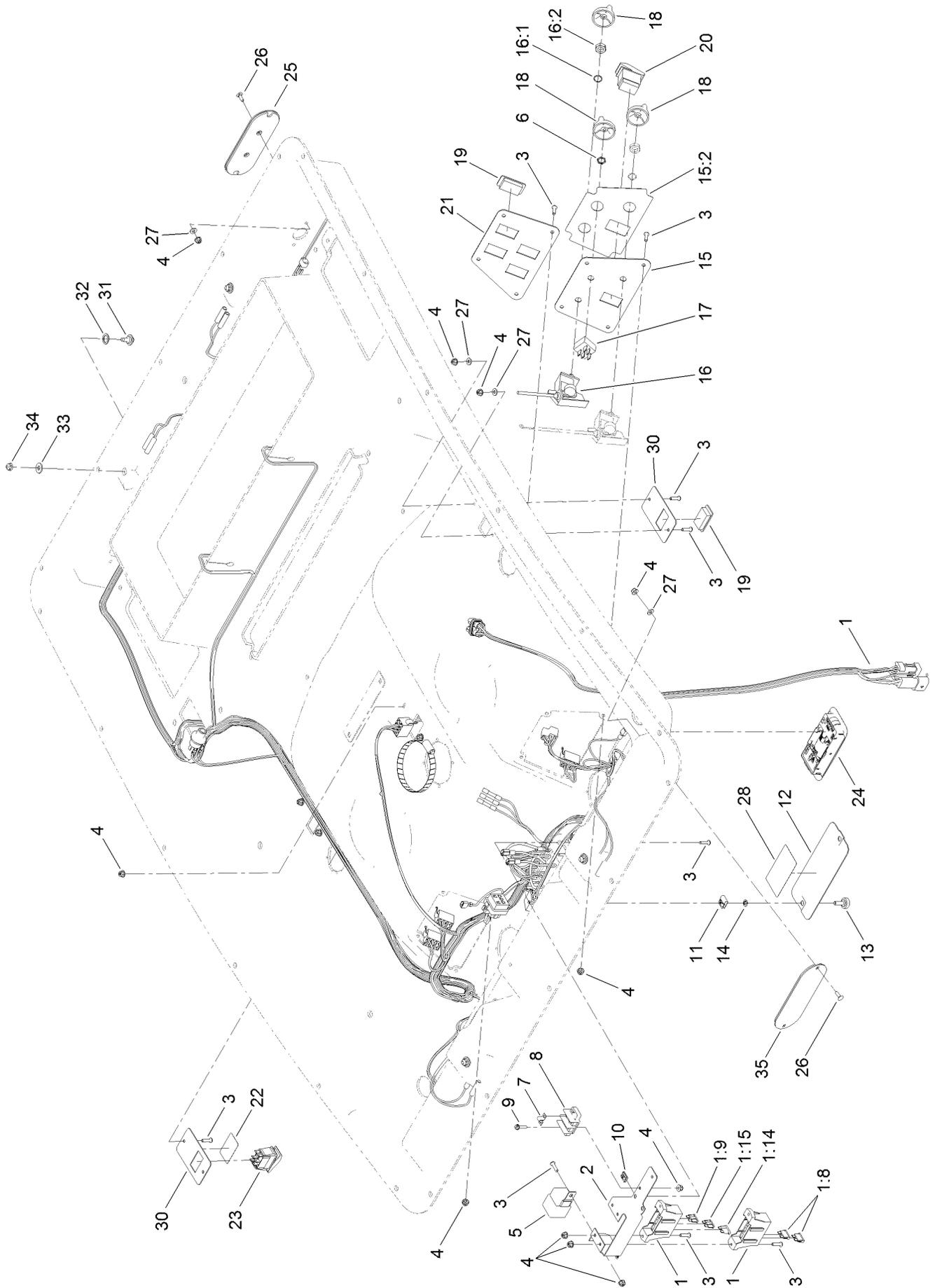

Headliner Wire Harness and Control Assembly (continued)

<i>Ref.</i>	<i>Part Number</i>	<i>Qty.</i>	<i>Description</i>	<i>Ref.</i>	<i>Part Number</i>	<i>Qty.</i>	<i>Description</i>
1	122-0723	1	Harness-Wire, Headliner	16:1	3254-20	1	Washer-Lock, Int
1:8	109355	2	Fuse-Blade, 15 Amp	16:2	3220-4	1	Nut-Jam
1:9	109103	1	Fuse-Blade, 30 Amp	17	122-0150	1	Switch, Rotary
1:14	109101	1	Fuse-Blade, 20 Amp	18	125-9510	3	Knob-Control
1:15	109102	1	Fuse-Blade, 25 Amp	19	99-7420	6	Plug-Hole
2	125-9606-03	1	Bracket-Fuse Block	20	95-8999	1	Switch-Rocker, On-None-On
3	104-2408	22	Screw-HSBH	21	125-9691-03	1	Panel-Switch, Lights
4	120-4578	29	Nut-HF	22	125-9688	1	Decal-Washer
5	99-7430	1	Relay-Mini	23	119-8355	1	Switch-Rocker
6	130-0588	1	Nut-Switch	24	125-7437	1	Light-Dome
7	42863	1	Strip-Jumper	25	130-5867	2	Cover-Light, Rear
8	42862	1	Block-Terminal, Ground	26	3229-34	8	Screw-CARR
9	32105-13	3	Screw-HWH	27	3256-14	14	Washer-Flat
10	107-1013	4	Nut-Speed	28	132-3600	1	Decal-Panel, Fuse
11	609900	2	Nut-Speed	30	130-0436	3	Panel-Switch
12	125-9603-03	1	Plate-Cover, Fuse	31	92-9698	4	Screw-Shoulder
13	125-7438	2	Knob-Screw, Thumb	32	94-8196	4	Washer-Nylon
14	106-8737	2	Nut-Retainer	33	3256-2	4	Washer-Flat
15	121-8481	1	Panel-Air/Heat	34	104-7201	4	Nut-HF, NI
15:2	121-8378	1	Decal, Air/Heat	35	130-5868	2	Cover-Light, Front
16	125-9677	1	Control-Rotary, Linear				

Mixing Box Mounting Bracket and Water Tray Assembly

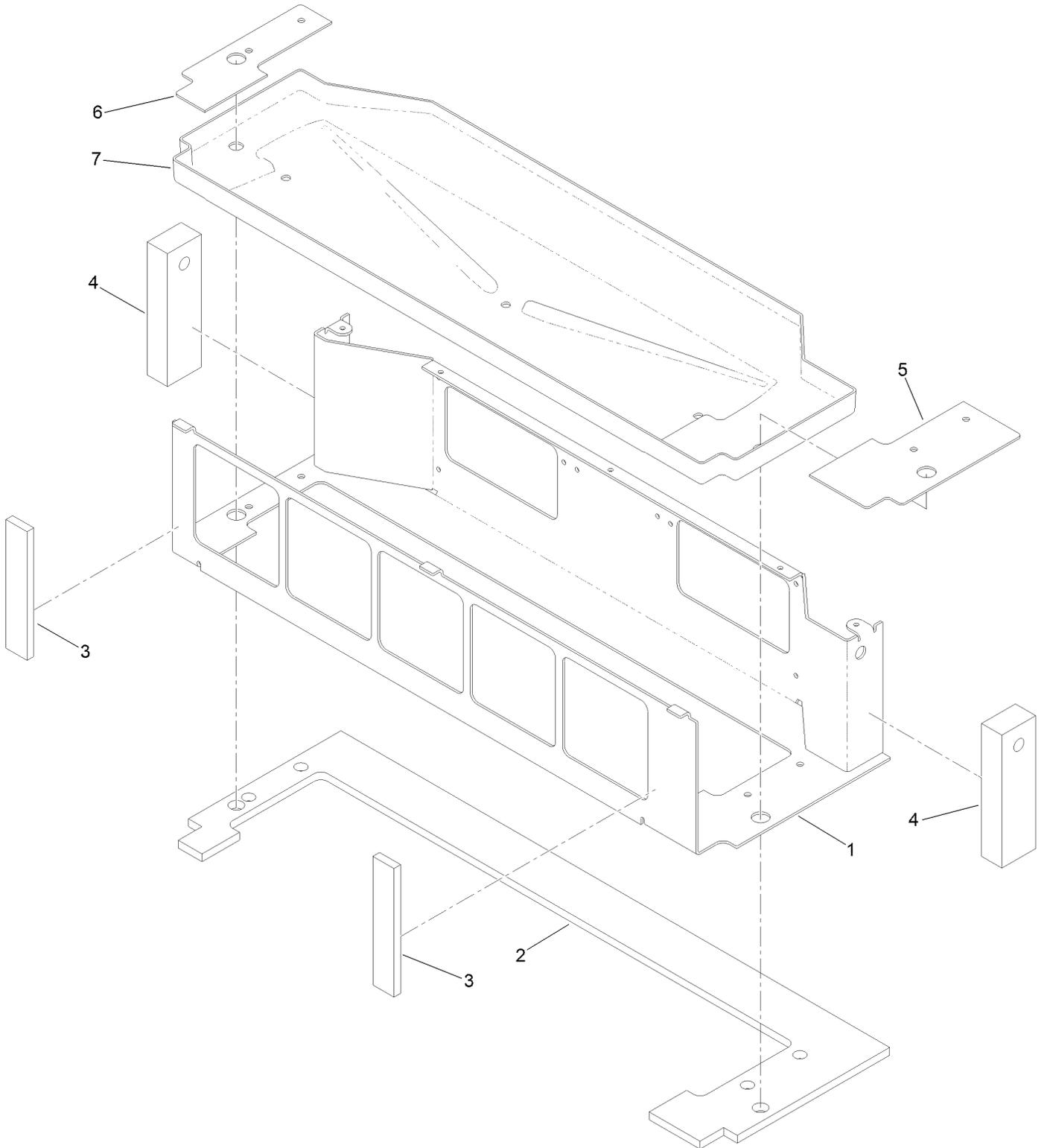

Mixing Box Mounting Bracket and Water Tray Assembly (continued)

<i>Ref.</i>	<i>Part Number</i>	<i>Qty.</i>	<i>Description</i>	<i>Ref.</i>	<i>Part Number</i>	<i>Qty.</i>	<i>Description</i>
1	130-5655-03	1	Bracket-Mount	5	130-5653	1	Gasket-Mount, LH Bracket
2	130-5659	1	Seal-Foam	6	130-5654	1	Gasket-Mount, RH Bracket
3	130-5808	2	Seal-Foam, Front	7	130-5660	1	Tray-Water
4	130-0602	2	Seal-End				

Blower Fan and Evaporator Core Assembly

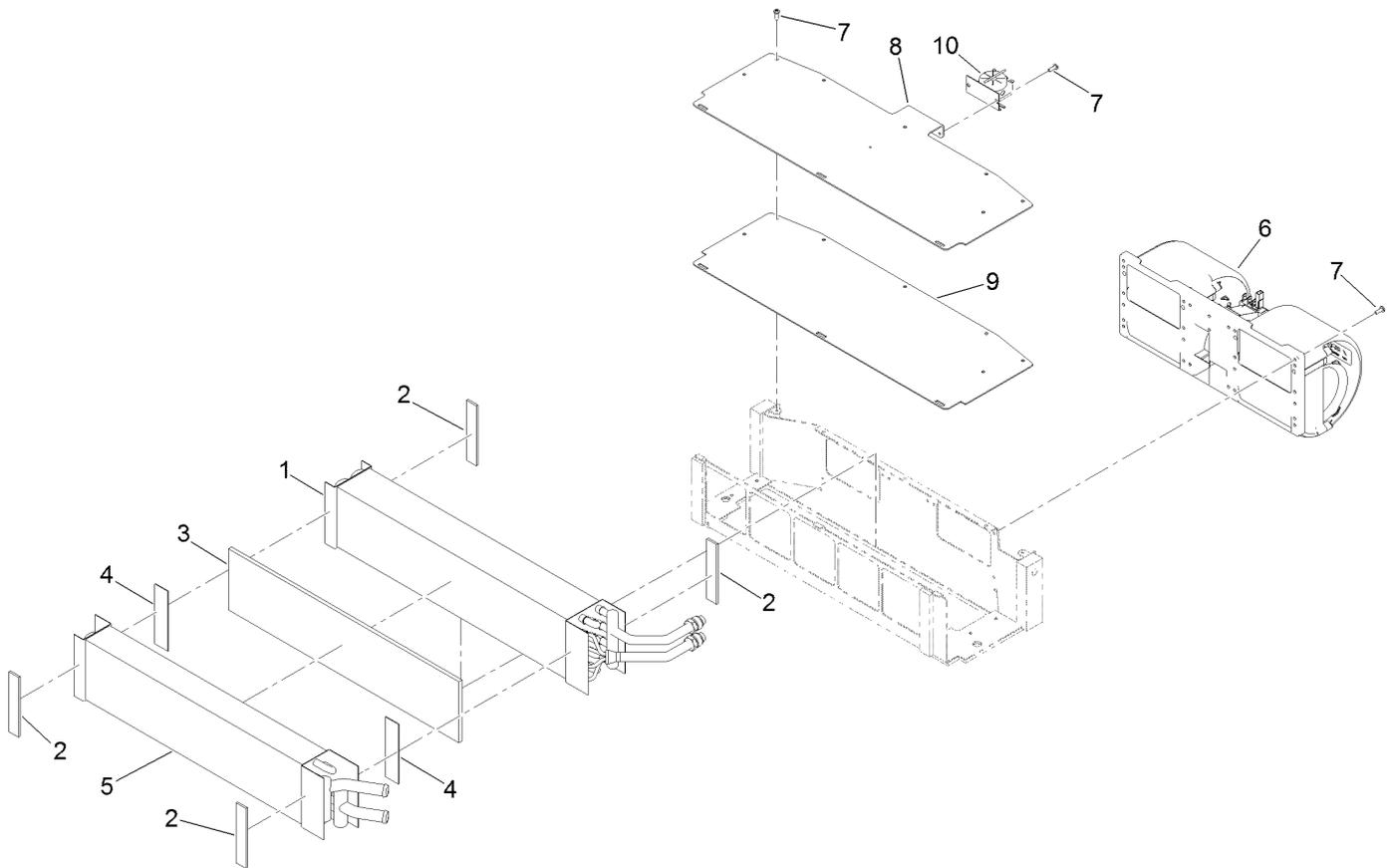

Blower Fan and Evaporator Core Assembly (continued)

<i>Ref.</i>	<i>Part Number</i>	<i>Qty.</i>	<i>Description</i>	<i>Ref.</i>	<i>Part Number</i>	<i>Qty.</i>	<i>Description</i>
1	130-5392	1	Core-Evaporator	7	363-8245	13	Screw-TAP
2	130-5658	4	Gasket-Coil	8	130-5656-03	1	Cover, Bracket-Mount
3	130-5807	1	Foam	9	130-5652	1	Gasket-Mount, Cover Bracket
4	130-5806	2	Tape, Double-Sided	10	121-8385	1	Thermostat-Switch, Freeze
5	127-9915	1	Core-Heater				
6	121-8451	1	Fan-Blower				

Heat/Air Conditioner Housing Assembly

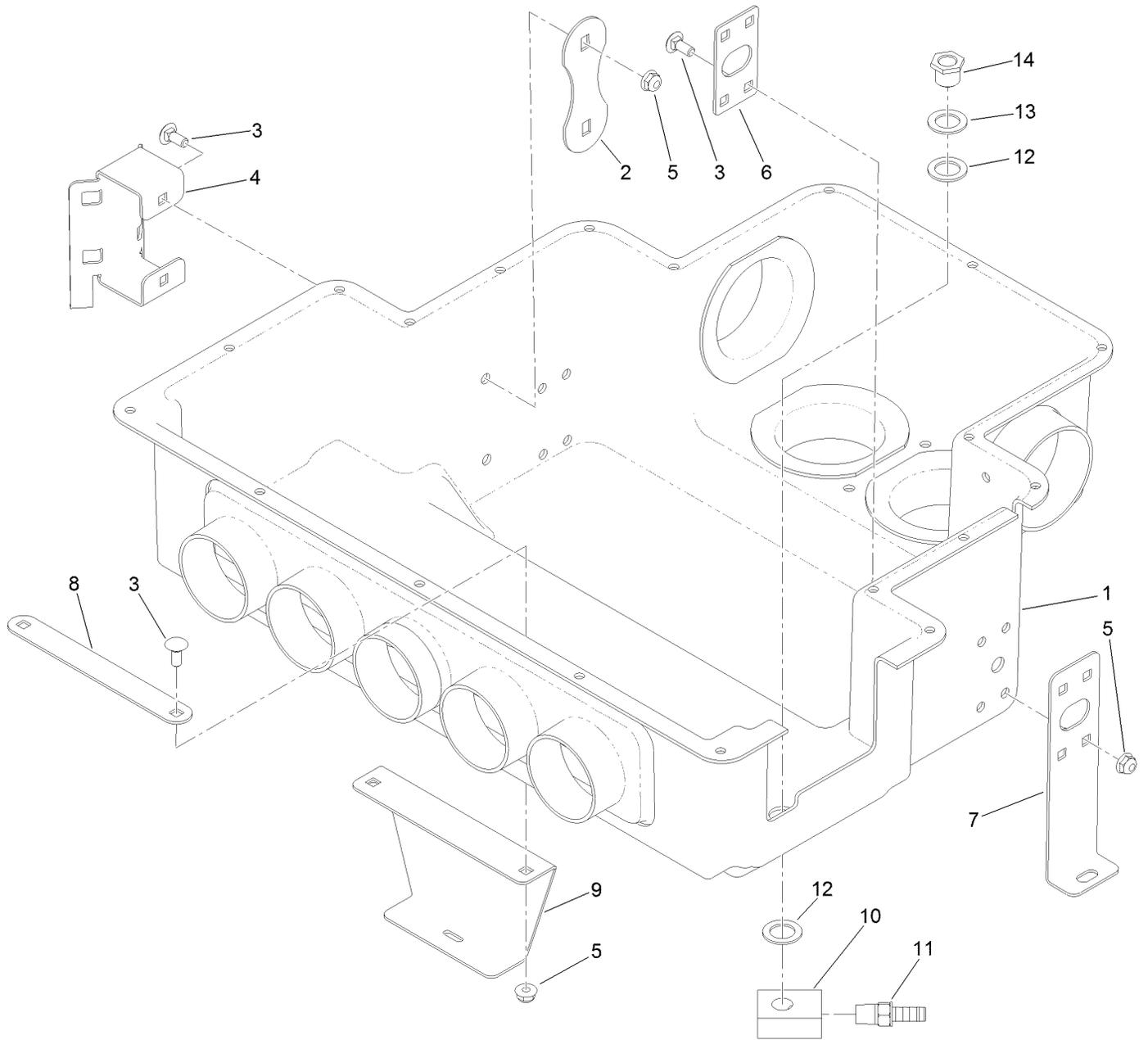

Heat/Air Conditioner Housing Assembly (continued)

<i>Ref.</i>	<i>Part Number</i>	<i>Qty.</i>	<i>Description</i>	<i>Ref.</i>	<i>Part Number</i>	<i>Qty.</i>	<i>Description</i>
1	130-5830	1	Housing-Heat/AC	8	125-7504	1	Plate-Backer, Center
2	121-8491	1	Plate-Support	9	130-0554	1	Bracket-Airbox, Center
3	3229-11	12	Screw-CARR	10	130-5601	2	Drain-Lower
4	121-8490	1	Bracket-Mount, Drier	11	108-0342	2	Fitting-Straight
5	104-7201	12	Nut-HF, NI	12	121-6840	4	Washer-Rubber
6	130-5834	2	Bracket-Support	13	107-3041	2	Washer-Flat
7	130-5821	2	Bracket-Airbox, Side	14	130-0293	2	Drain-Upper

Air Diverter and Expansion Valve Assembly

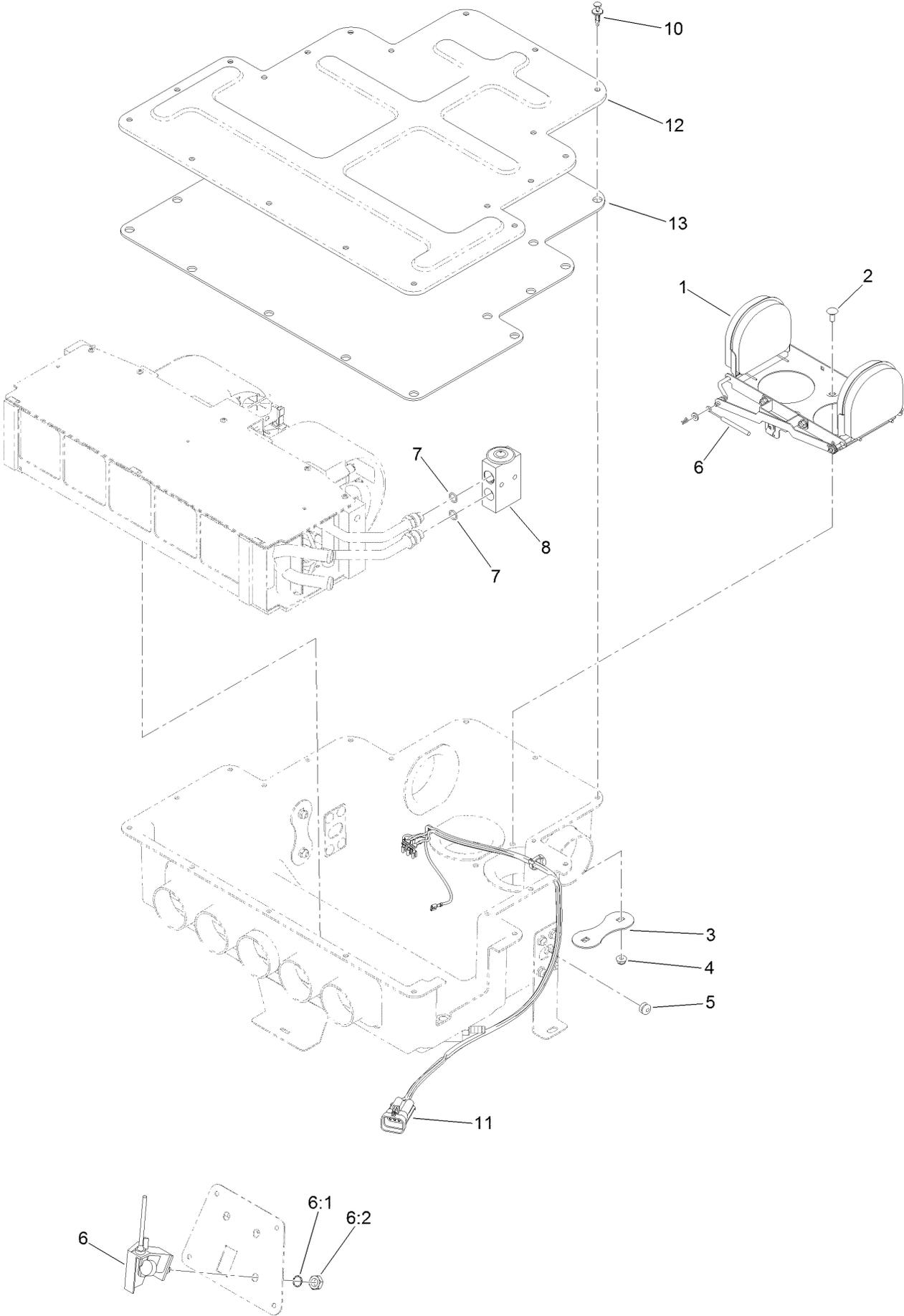

Air Diverter and Expansion Valve Assembly (continued)

<i>Ref.</i>	<i>Part Number</i>	<i>Qty.</i>	<i>Description</i>	<i>Ref.</i>	<i>Part Number</i>	<i>Qty.</i>	<i>Description</i>
1	121-8369	1	Air Diverter ASM	7	125-9524	2	O-Ring
2	3229-11	2	Screw-CARR	8	121-8384	1	Valve-Expansion
3	121-8491	1	Plate-Support	10	125-9622	19	Rivet-Blind
4	104-7201	2	Nut-HF, NI	11	122-0153	1	Harness-Wire, Heat/AC Blower
5	125-7528	1	Grommet-Cable	12	121-8449	1	Housing-Ventilation, Upper
6	125-9678	1	Control-Rotary, Linear	13	130-5614	1	Insulation-Cover
6:1	3254-20	1	Washer-Lock, Int				
6:2	3220-4	1	Nut-Jam				

Air Diverter Assembly No. 121-8369

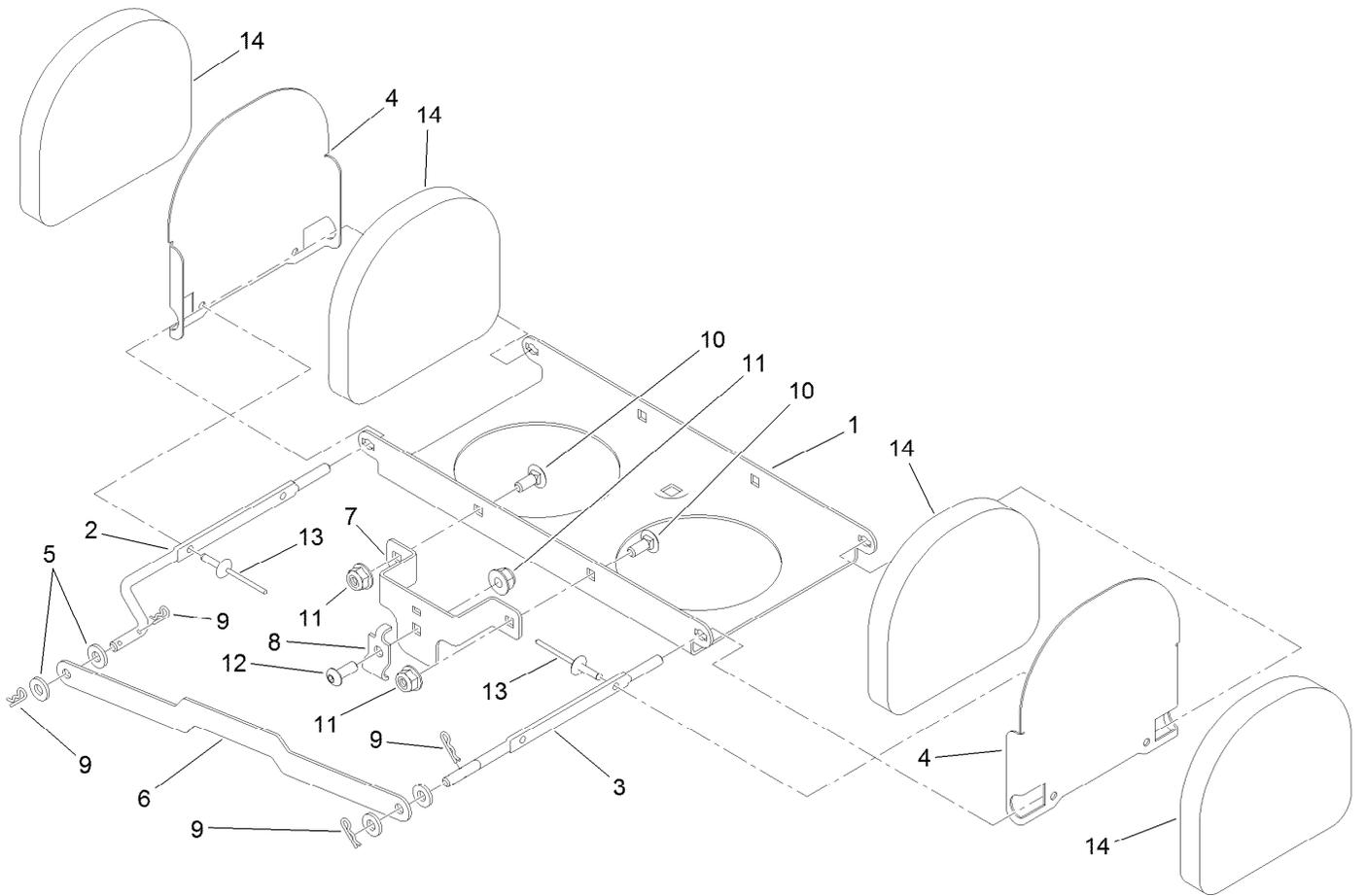

Air Diverter Assembly No. 121-8369 (continued)

<i>Ref.</i>	<i>Part Number</i>	<i>Qty.</i>	<i>Description</i>	<i>Ref.</i>	<i>Part Number</i>	<i>Qty.</i>	<i>Description</i>
1	125-9697	1	Base-Mount	8	121-8256	1	Clamp-Conduit
2	121-8381	1	Shaft-Baffle, RH	9	108-2992	4	Pin-Hair
3	121-8382	1	Shaft-Baffle, LH	10	1-807513	2	Bolt-CARR
4	125-9698	2	Baffle-Air	11	120-4578	3	Nut-HF
5	3256-51	4	Washer-Flat	12	115-9830	1	Screw-HSBH
6	125-9696	1	Link-Baffle	13	3290-271	4	Rivet-Pop
7	121-8374	1	Mount-Cable	14	125-9699	4	Damper-Foam

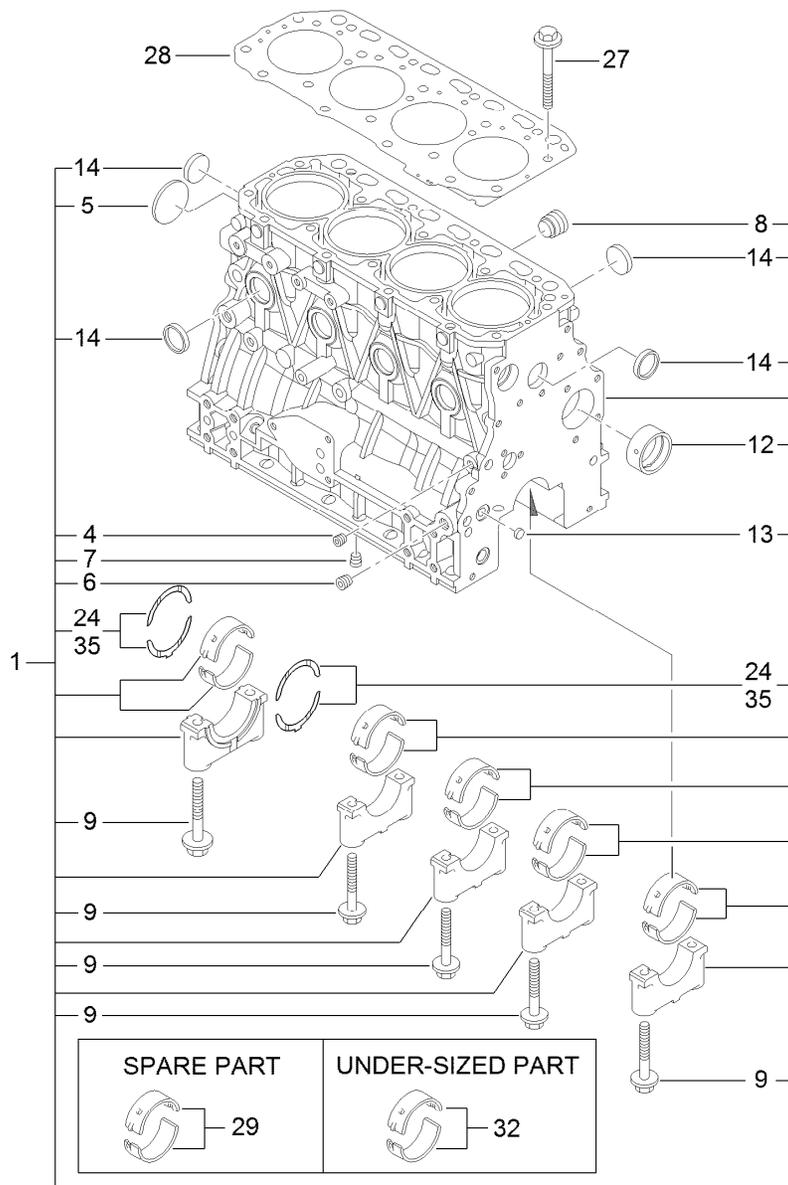

Cylinder Block Assembly

<i>Ref.</i>	<i>Part Number</i>	<i>Qty.</i>	<i>Description</i>	<i>Ref.</i>	<i>Part Number</i>	<i>Qty.</i>	<i>Description</i>
1	125-7244	1	Cylinder Block ASM	13	125-7237	2	Plug
4	125-6969	1	Plug	14	125-7239	8	Plug
5	125-6980	1	Plug	24	125-7010	2	Metal-Thrust
6	125-6973	1	Plug	27	125-7006	18	Bolt
7	125-6973	1	Plug	28	125-7049	1	Gasket-Head
8	125-7170	1	Plug	29	125-6981	5	Metal-Main
9	125-7007	10	Bolt	32	125-7009	5	Metal-Main (0.25)
12	125-7108	1	Bushing	35	125-7011	1	Metal-Thrust (0.25)

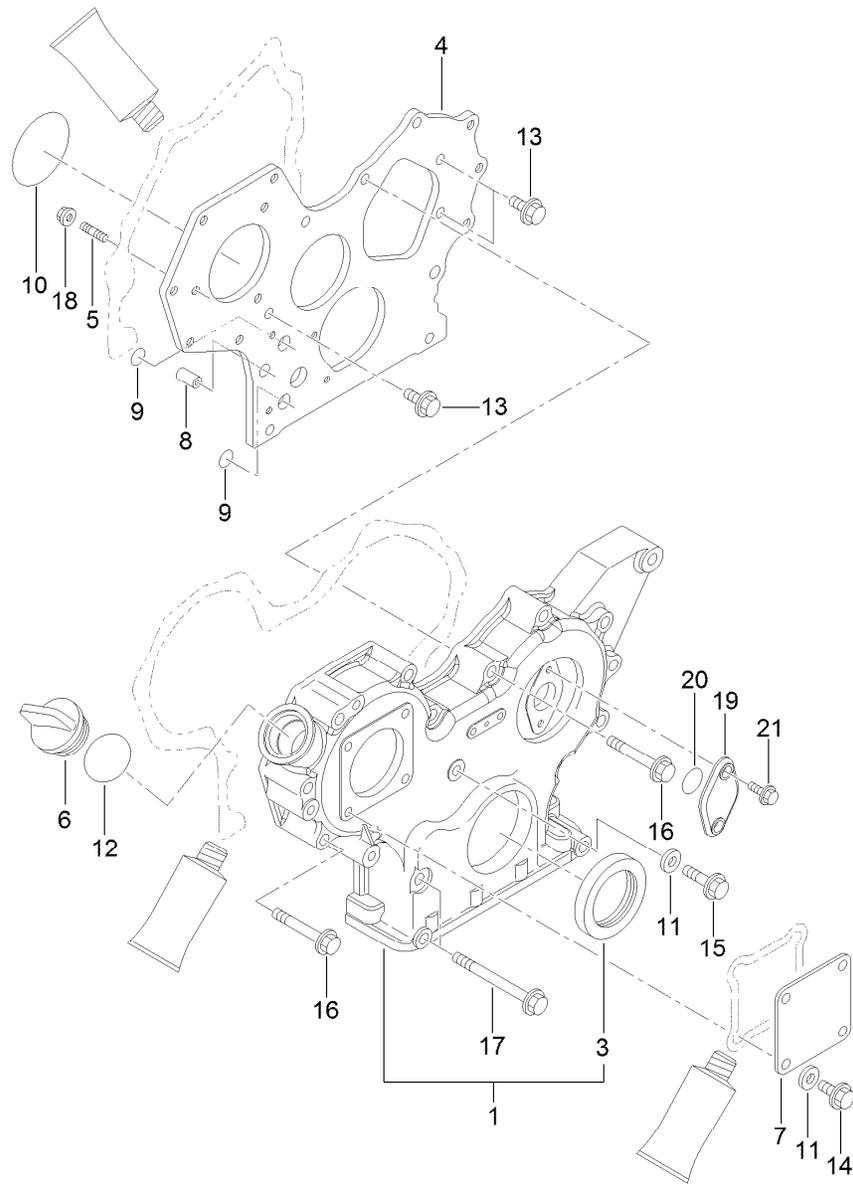

Gear Housing Assembly

<i>Ref.</i>	<i>Part Number</i>	<i>Qty.</i>	<i>Description</i>	<i>Ref.</i>	<i>Part Number</i>	<i>Qty.</i>	<i>Description</i>
1	125-7247	1	Case ASM	12	125-7197	1	O-Ring
3	125-6944	1	Seal-Oil	13	125-7214	3	Bolt
4	125-6936	1	Flange	14	125-7214	4	Bolt
5	125-6919	3	Stud	15	125-7216	1	Bolt
6	125-6972	1	Cover-Filler	16	125-7221	12	Bolt
7	125-6977	1	Cover	17	125-7224	3	Bolt
8	125-7107	2	Pipe	18	125-7229	3	Nut
9	125-6909	2	O-Ring	19	125-6950	1	Cover
10	125-6957	1	O-Ring	20	125-7199	1	O-Ring
11	125-7174	5	Washer-Seal	21	125-7208	2	Bolt

Cylinder Head and Bonnet Assembly

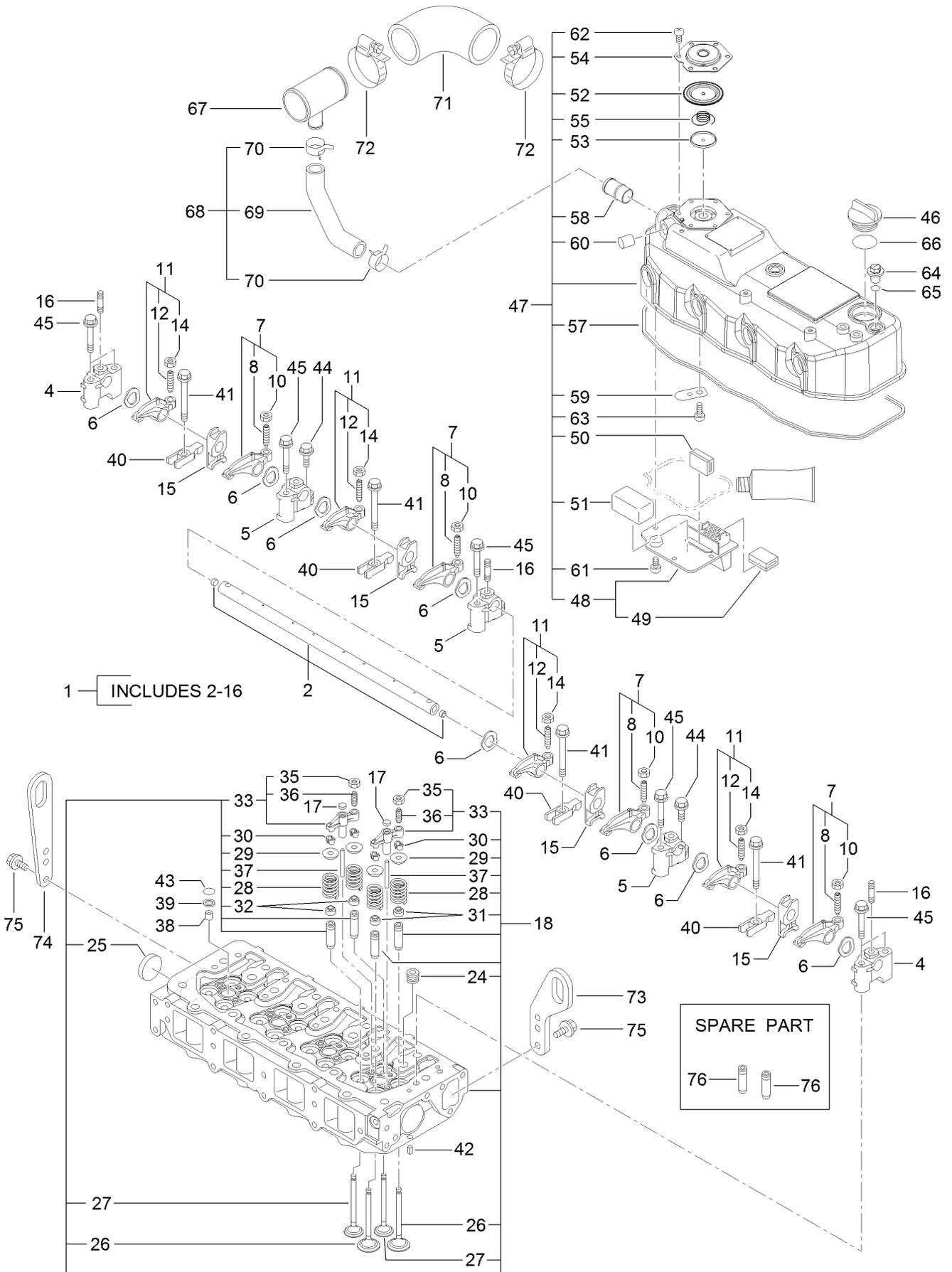

Cylinder Head and Bonnet Assembly (continued)

<i>Ref.</i>	<i>Part Number</i>	<i>Qty.</i>	<i>Description</i>	<i>Ref.</i>	<i>Part Number</i>	<i>Qty.</i>	<i>Description</i>
1	125-7055	1	Shaft ASM	43	93-0418	4	O-Ring
2	125-7056	1	Shaft	44	125-7215	3	Bolt
4	125-7057	2	Support	45	125-7220	7	Bolt
5	125-7058	3	Support	46	125-6972	1	Cover-Filler
6	125-7059	8	Washer	47	125-7099	1	Bonnet ASM
7	125-7061	4	Arm-Rocker	48	125-7050	1	Plate
8	125-7013	4	Screw-Adjust, Valve	49	125-6920	1	Baffle
10	125-7014	4	Nut	50	125-7012	1	Baffle
11	125-7062	4	Arm-Rocker	51	125-7118	1	Baffle-Breather
12	125-7013	4	Screw-Adjust, Valve	52	125-6959	1	Diaphragm
14	125-7014	4	Nut	53	125-6960	1	Plate
15	125-7593	1	Retainer	54	125-6961	1	Plate-Breather
16	125-7228	3	Stud	55	125-6962	1	Spring-Diaphragm
17	125-6963	8	Seat-Bridge, Valve	57	125-7060	1	Gasket
18	125-7089	1	Cylinder Head ASM	58	125-6982	1	Pipe
24	125-7196	4	Plug	59	125-6994	1	Spring
25	125-7240	2	Plug	60	125-6913	1	Plug
26	125-7051	8	Valve	61	125-7186	4	Screw
27	125-7052	8	Valve	62	125-7186	6	Screw
28	125-7053	16	Spring	63	125-7186	1	Screw
29	125-7054	16	Retainer	64	125-6974	3	Knob
30	125-6914	32	Cotter	65	93-0418	3	O-Ring
31	125-6915	8	Seal-Stem, Valve	66	125-7197	1	O-Ring
32	125-6916	8	Seal-Stem, Valve	67	125-7086	1	Joint
33	125-7104	8	Bridge ASM	68	125-7087	1	Hose ASM
35	125-7014	8	Nut	69	125-7088	1	Hose
36	125-6965	8	Adjuster	70	125-7040	2	Clip-Hose
37	125-7063	8	Guide	71	125-7090	1	Hose
38	125-6921	4	Protector	72	125-7190	2	Clamp-Hose
39	125-6911	4	Seat-Valve	73	125-7046	1	Lifter
40	125-7064	4	Retainer	74	125-7111	1	Lifter
41	125-7119	4	Bolt	75	125-7214	4	Bolt
42	125-7184	2	Pin-Spring	76	125-6917	16	Guide

Fuel Injection Pump Assembly

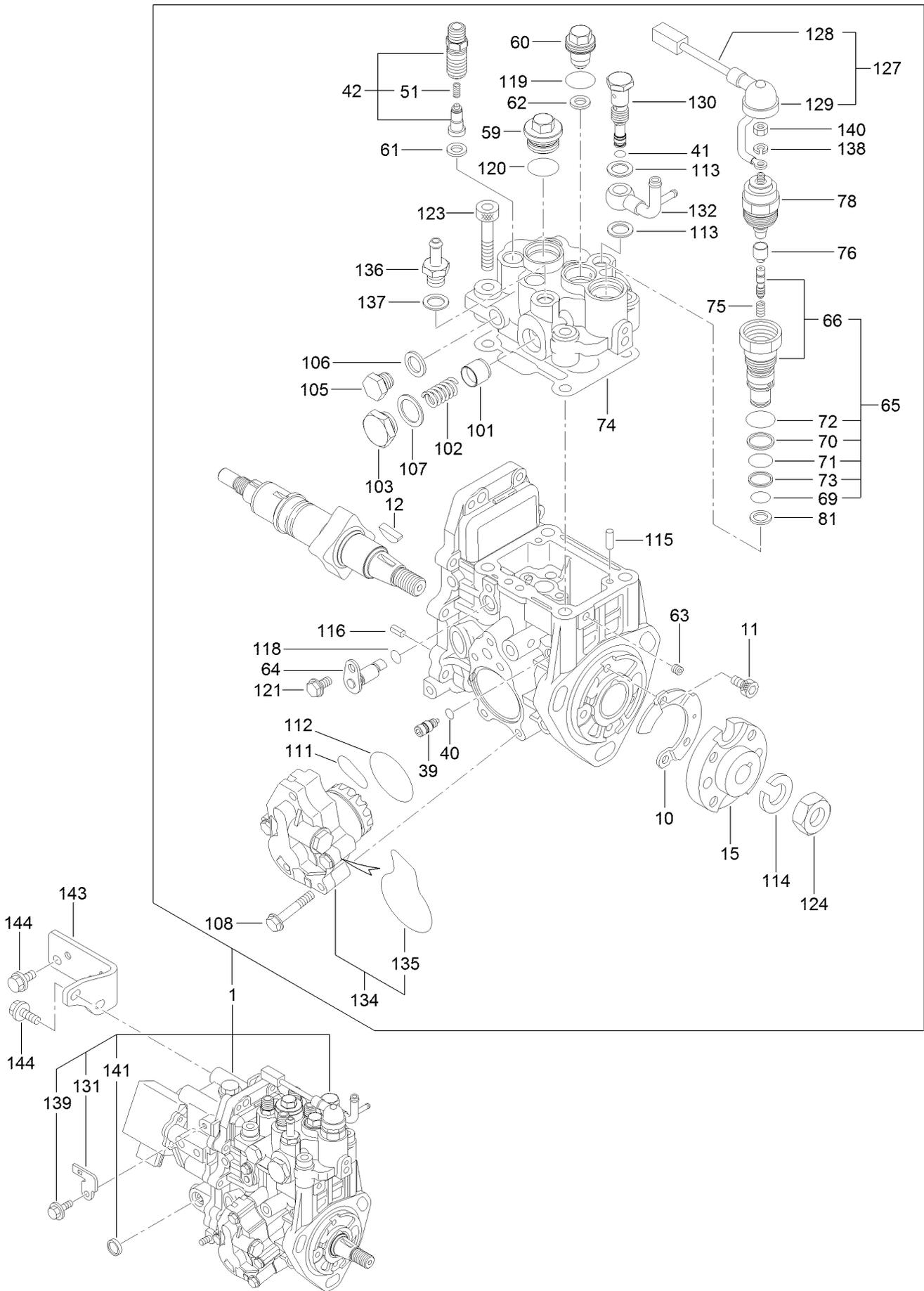

Fuel Injection Pump Assembly (continued)

<i>Ref.</i>	<i>Part Number</i>	<i>Qty.</i>	<i>Description</i>	<i>Ref.</i>	<i>Part Number</i>	<i>Qty.</i>	<i>Description</i>
1	125-7246	1	Fie ASM	106	125-7176	1	Washer-Seal
10	125-6991	1	Cover	107	125-7591	1	Washer-Seal
11	125-6992	2	Bolt	108	125-7147	4	Bolt
12	125-6932	1	Key	111	125-7142	1	O-Ring
15	125-7135	1	Flange	112	125-7143	1	O-Ring
39	125-7156	1	Stopper	113	125-7176	2	Washer-Seal
40	125-7154	1	O-Ring	114	125-7179	1	Washer-Spring
41	125-7154	1	O-Ring	115	125-7181	2	Pin-Parallel
42	125-7092	4	Valve ASM	116	125-7183	2	Pin-Spring
51	125-7155	4	Spring	118	93-0400	1	O-Ring
59	125-7157	1	Plug	119	125-7201	1	O-Ring
60	125-6933	1	Plug	120	125-7202	1	O-Ring
61	125-7136	4	Gasket	121	125-7205	1	Bolt
62	125-7136	1	Gasket	123	125-7233	4	Bolt
63	125-7151	1	Plug	124	125-7236	1	Nut
64	125-7137	1	Lifter	127	125-7125	1	Harness ASM
65	125-7102	1	Timer Set	128	125-7126	1	Harness
66	125-7103	1	Timer ASM	129	125-7033	1	Cap
69	125-7145	1	O-Ring	130	125-7158	1	Joint
70	125-6934	1	Ring	131	125-7127	1	Bracket
71	125-6935	1	O-Ring	132	125-7139	1	Joint
72	125-7202	1	O-Ring	134	125-7141	1	Feed Pump ASM
73	125-7203	1	Ring-Back Up	135	125-7144	1	O-Ring
74	125-7138	1	Gasket	136	125-6945	1	Joint
75	125-6940	1	Spring	137	125-7176	1	Washer-Seal
76	125-6941	1	Cap	138	125-7178	1	Washer-Spring
78	125-6942	1	Solenoid Valve ASM	139	125-7207	1	Bolt
81	125-7146	1	Gasket	140	125-7235	1	Nut
101	125-7159	1	Piston	141	125-7238	1	Plug
102	125-7140	1	Spring	143	125-7032	1	Retainer
103	125-7160	1	Plug	144	125-7214	4	Bolt
105	125-7148	1	Plug				

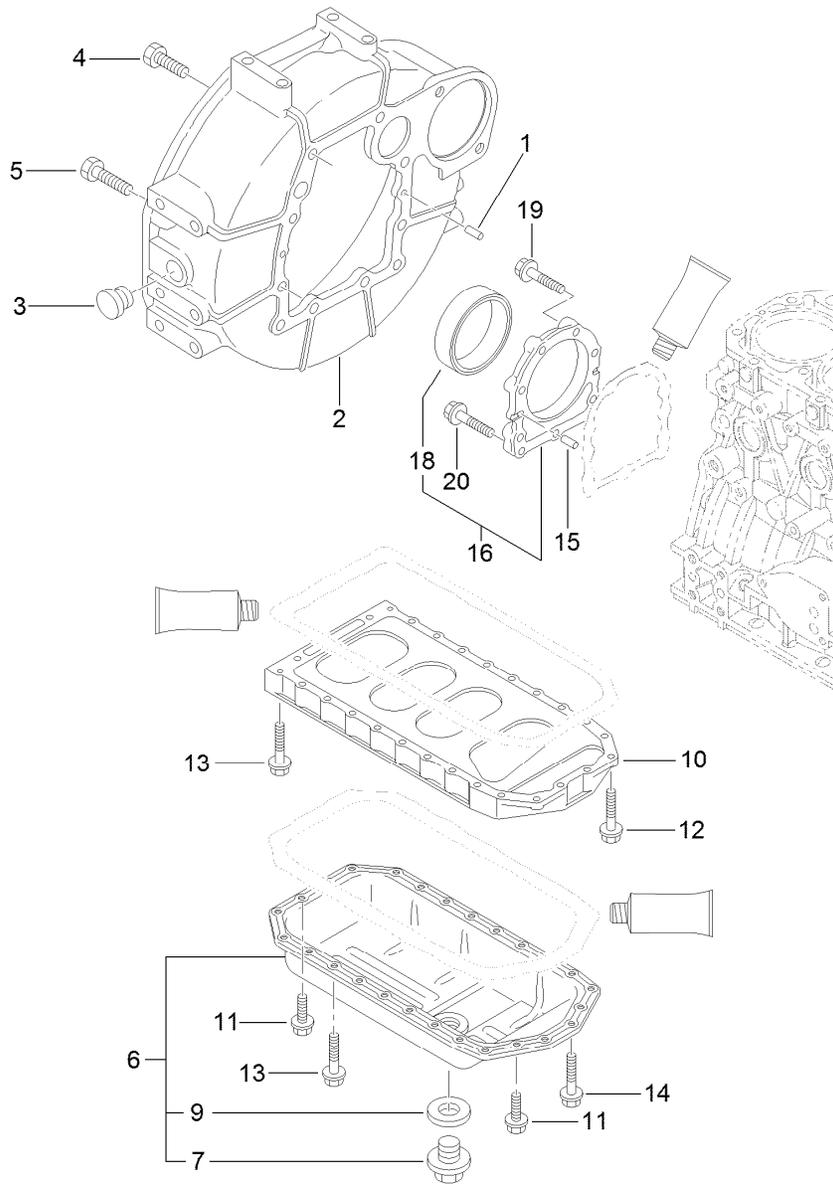

Flywheel Housing and Oil Sump Assembly

Ref.	Part Number	Qty.	Description
1	125-6995	2	Pin
2	125-7100	1	Housing
3	125-6910	1	Cap
4	125-7226	6	Bolt
5	125-7227	4	Bolt
6	125-7241	1	Oil Sump ASM
7	125-6912	1	Plug-Drain
9	125-7177	1	Washer-Seal
10	125-7035	1	Spacer

Ref.	Part Number	Qty.	Description
11	125-7214	4	Bolt
12	125-7215	2	Bolt
13	125-7219	20	Bolt
14	125-7220	4	Bolt
15	125-6995	2	Pin
16	125-6996	1	Case ASM
18	125-7106	1	Seal-Oil
19	125-7045	6	Bolt
20	125-7217	3	Bolt

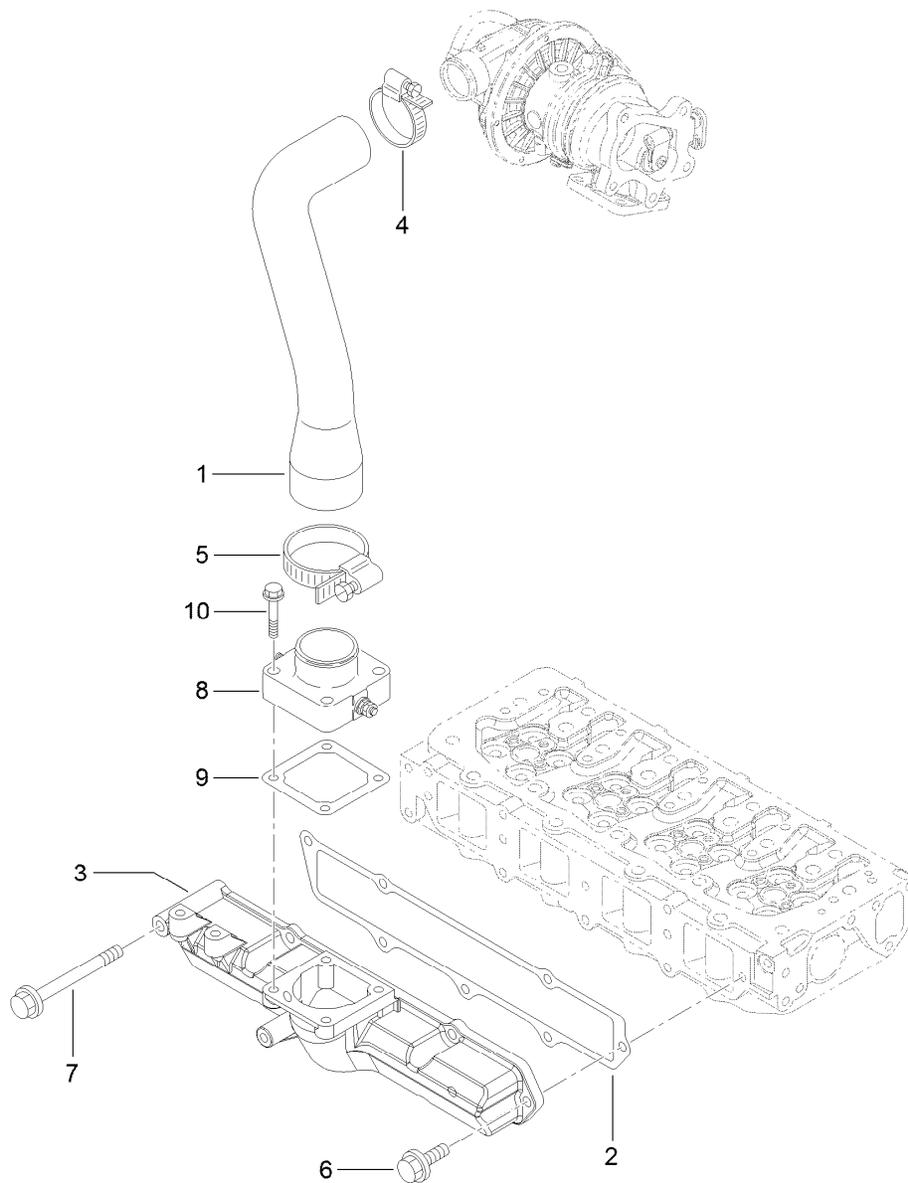

Suction Manifold Assembly

<i>Ref.</i>	<i>Part Number</i>	<i>Qty.</i>	<i>Description</i>
1	125-7065	1	Pipe
2	125-7066	1	Gasket
3	125-7067	1	Manifold-Intake
4	125-7189	1	Clamp-Hose
5	125-7190	1	Clamp-Hose
6	125-7595	6	Bolt
7	125-7223	1	Bolt
8	125-7002	1	Heater
9	125-7028	1	Gasket
10	125-7217	4	Bolt

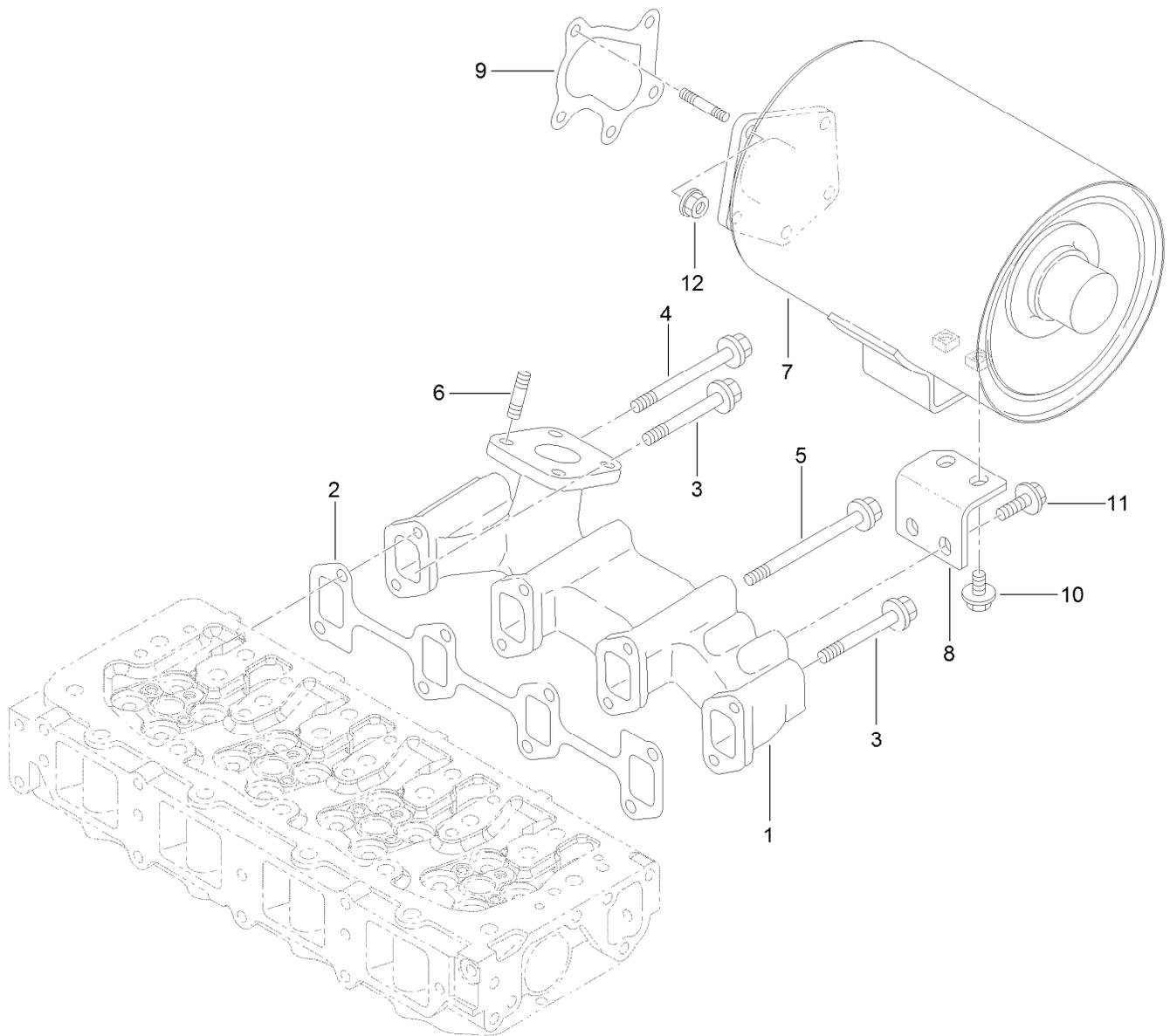

Exhaust Manifold and Silencer Assembly

<i>Ref.</i>	<i>Part Number</i>	<i>Qty.</i>	<i>Description</i>
1	125-7093	1	Manifold-Exhaust
2	125-7096	1	Gasket
3	125-6922	3	Bolt
4	125-6923	1	Bolt
5	125-6924	4	Bolt
6	125-6906	4	Stud
7	125-7094	1	Silencer
8	125-7095	1	Support-Silencer
9	125-7071	1	Gasket
10	125-7213	2	Bolt
11	125-7595	2	Bolt
12	125-7229	5	Nut

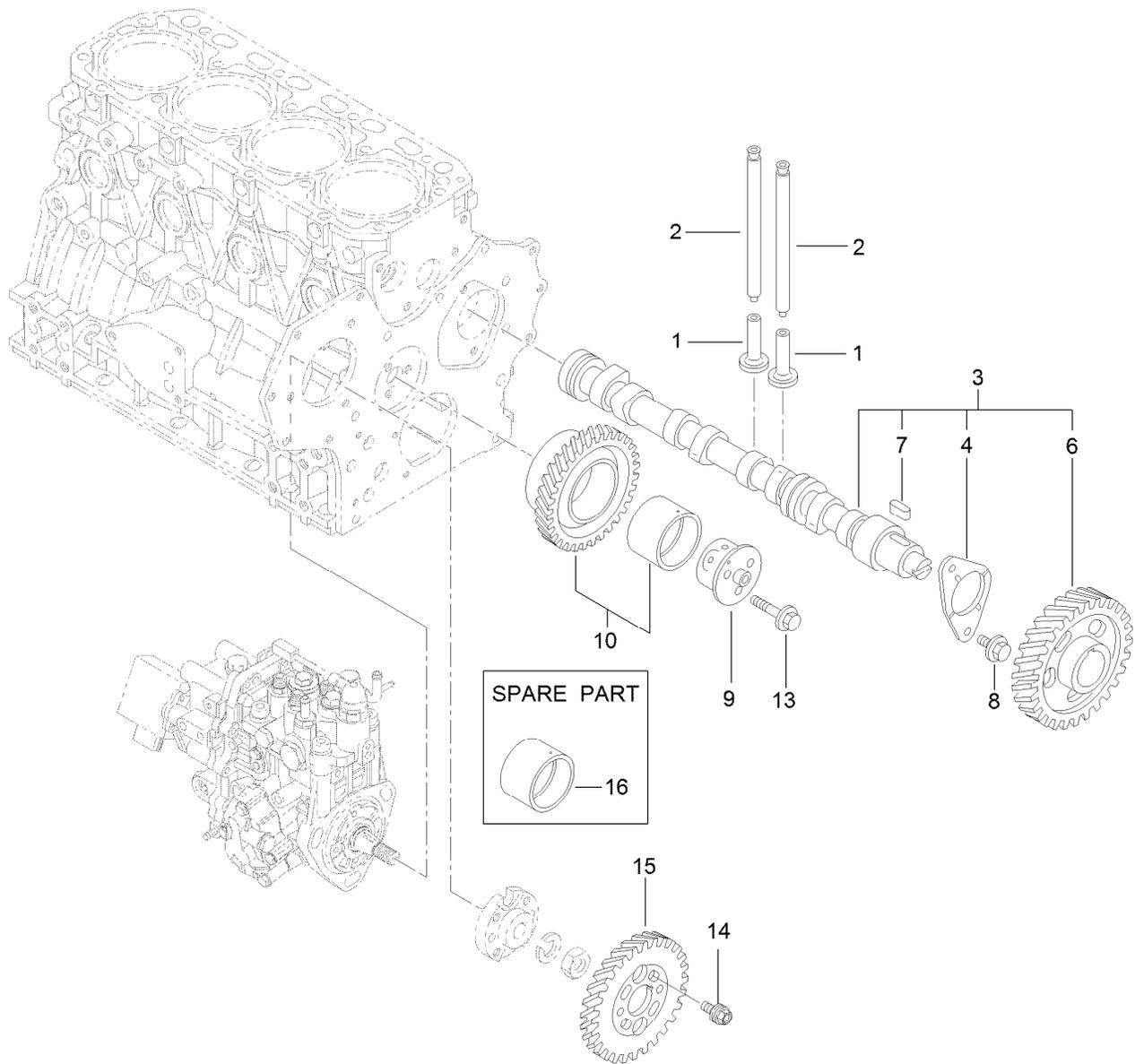

Camshaft and Driving Gear Assembly

Ref.	Part Number	Qty.	Description
1	125-7016	8	Tappet
2	125-7017	8	Rod-Push
3	125-7068	1	Camshaft ASM
4	125-7008	1	Metal-Thrust
6	125-7015	1	Gear
7	125-7185	1	Key
8	125-7213	2	Bolt
9	125-6938	1	Shaft
10	125-6928	1	Gear ASM
13	125-7218	3	Bolt
14	125-7020	4	Bolt
15	125-6929	1	Gear
16	125-6927	1	Bushing

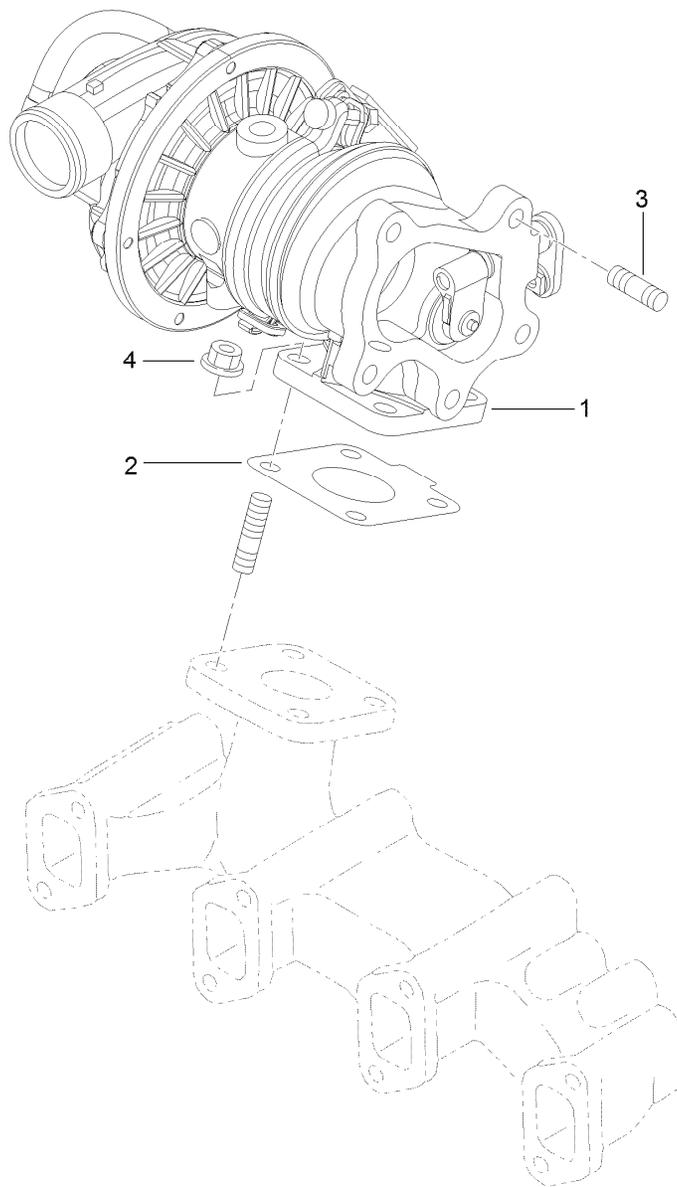

Turbine Assembly

<i>Ref.</i>	<i>Part Number</i>	<i>Qty.</i>	<i>Description</i>
1	125-7069	1	Turbine
2	125-7070	1	Gasket
3	125-7043	5	Stud
4	125-7229	4	Nut

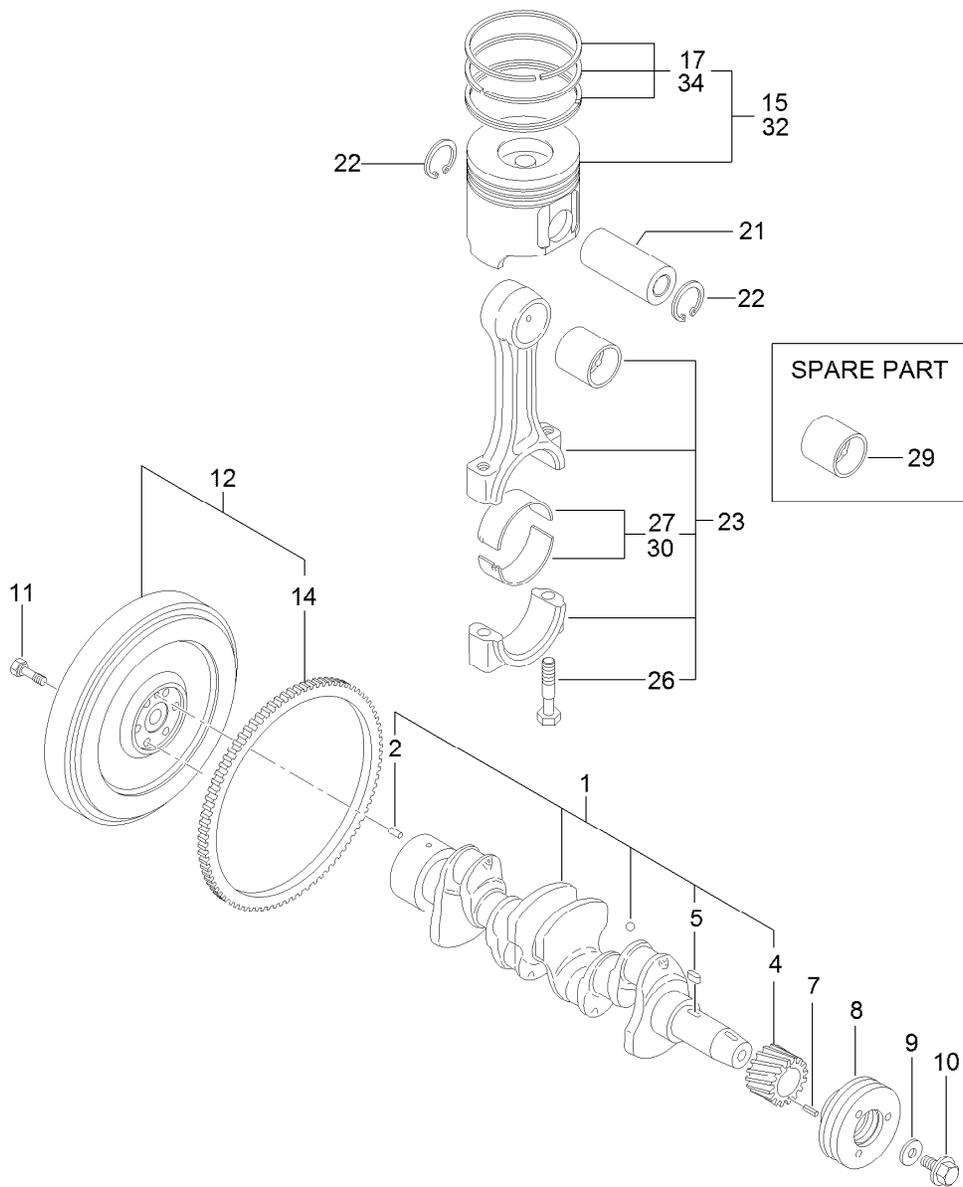

Crankshaft and Piston Assembly

<i>Ref.</i>	<i>Part Number</i>	<i>Qty.</i>	<i>Description</i>	<i>Ref.</i>	<i>Part Number</i>	<i>Qty.</i>	<i>Description</i>
1	125-7091	1	Crankshaft ASM	15	125-7072	4	Piston ASM
2	125-6995	1	Pin	17	125-6983	4	Piston Ring Set
4	125-6937	1	Gear	21	125-7030	4	Pin
5	125-7185	1	Key	22	125-7180	8	Ring
7	125-7182	1	Pin-Spring	23	125-7242	4	Connecting Rod ASM
8	125-6925	1	V-Pulley	26	125-6955	8	Bolt
9	125-7109	1	Washer	27	125-7018	4	Pin-Crank
10	125-6956	1	Bolt	29	125-6997	4	Pin-Piston
11	125-6951	6	Bolt	30	125-7019	4	Pin-Crank (.25)
12	125-7172	1	Flywheel ASM	32	125-7073	4	Piston ASM (0.25 Os)
14	125-6943	1	Gear	34	125-6985	4	Piston Ring Set (.25)

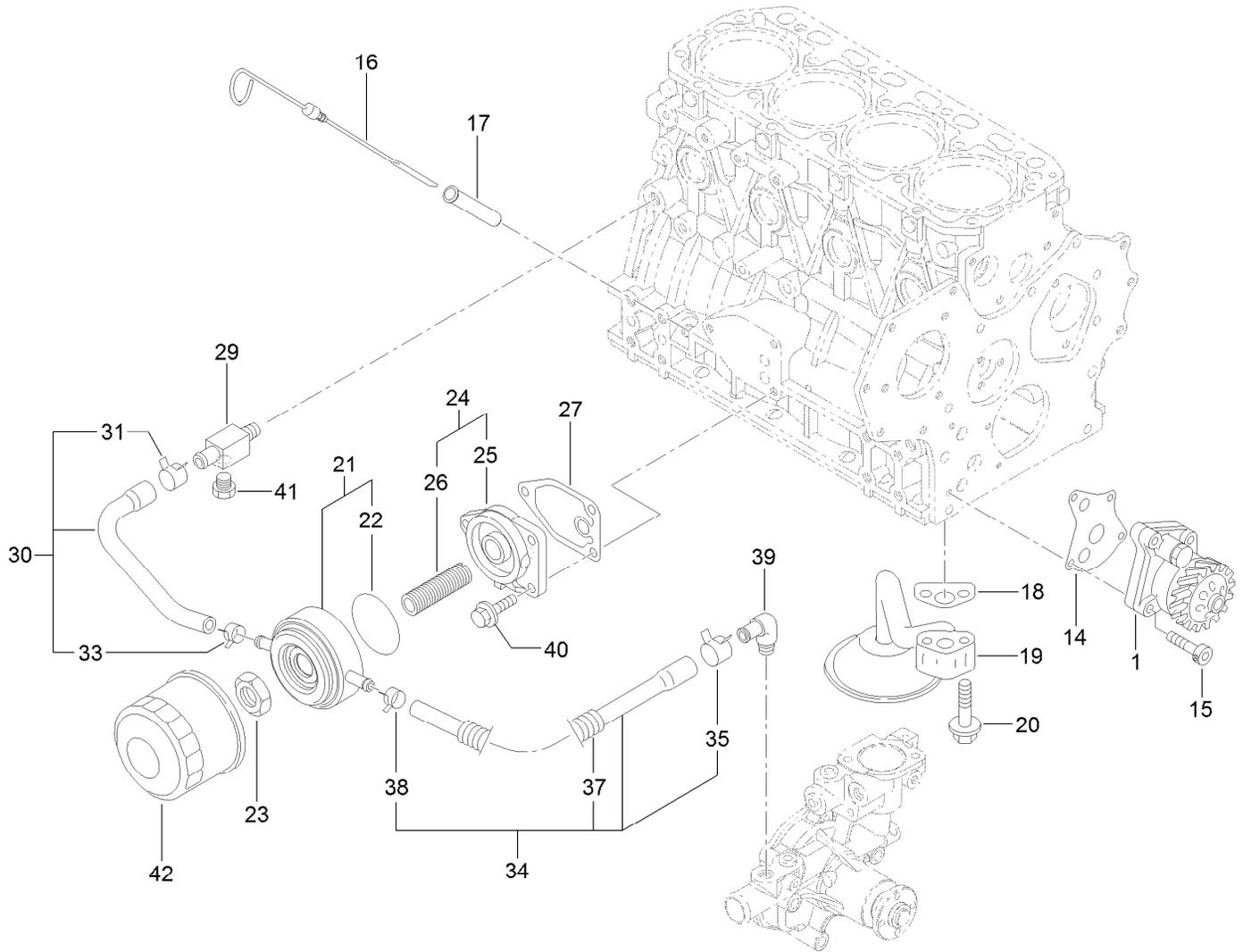

Lubrication and Oil System Assembly

<i>Ref.</i>	<i>Part Number</i>	<i>Qty.</i>	<i>Description</i>	<i>Ref.</i>	<i>Part Number</i>	<i>Qty.</i>	<i>Description</i>
1	125-7044	1	Oil Pump ASM	27	125-7024	1	Gasket
14	125-7021	1	Gasket	29	125-6990	1	Joint
15	125-7232	4	Bolt	30	125-7078	1	Pipe ASM
16	125-6987	1	Dipstick	31	125-7162	1	Clip
17	125-6954	1	Guide-Dipstick	33	125-7191	1	Clamp-Hose
18	125-7022	1	Gasket	34	125-7079	1	Pipe ASM
19	125-7023	1	Pipe ASM	35	125-7162	1	Clip
20	125-7217	2	Bolt	37	125-6946	1	Tube
21	125-7074	1	Cooler ASM	38	125-7191	1	Clamp-Hose
22	125-7075	1	O-Ring	39	125-7001	1	Elbow
23	125-7041	1	Nut-Cooler, Oil	40	125-7595	3	Bolt
24	125-6989	1	Bracket ASM	41	125-7171	1	Plug-Drain
25	125-6930	1	Bracket	42	125-7025	1	Filter-Engine, Oil
26	125-7042	1	Stud				

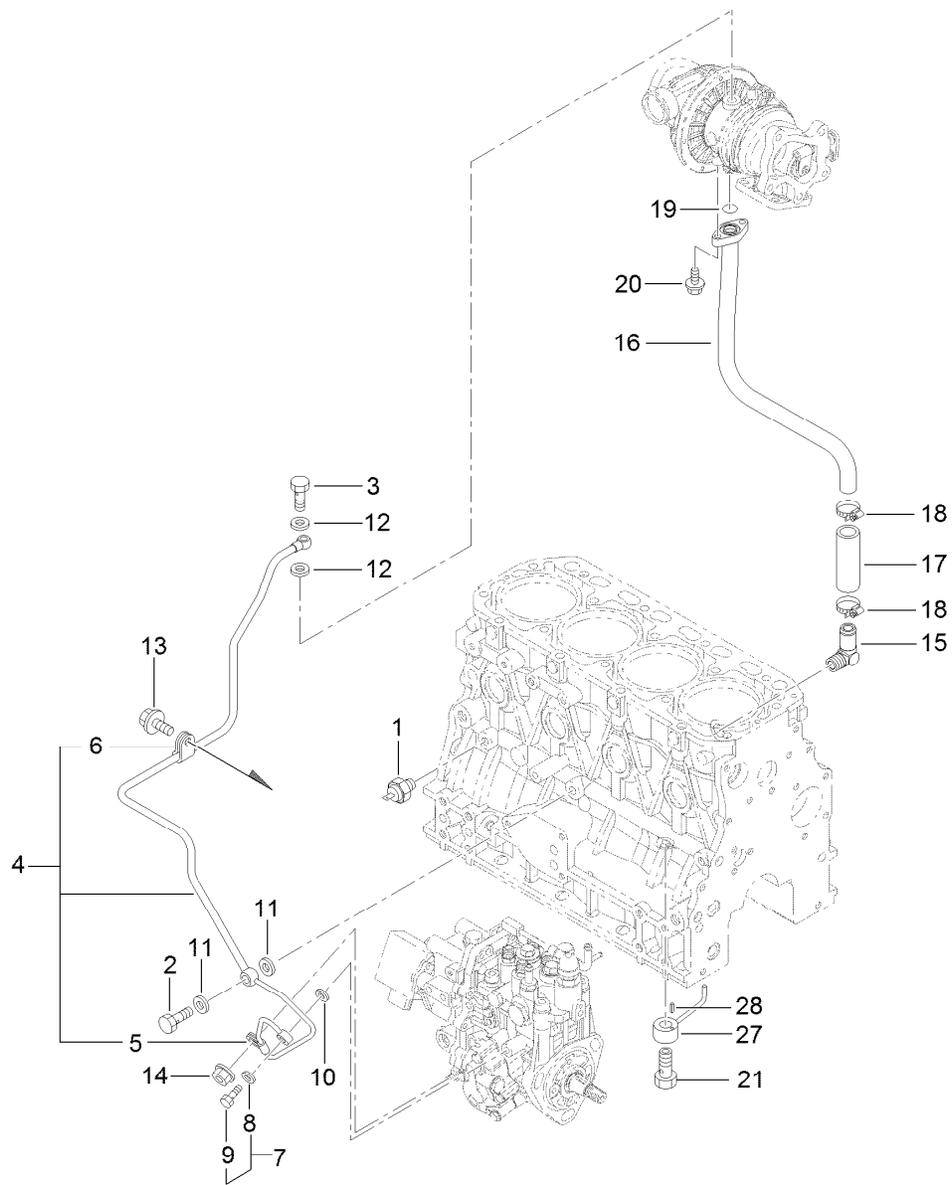

Lubrication Oil Line Assembly

Ref.	Part Number	Qty.	Description
1	125-6918	1	Switch-Oil
2	125-6975	1	Bolt-Joint, Pipe
3	125-6952	1	Bolt-Joint, Pipe
4	125-7076	1	Pipe ASM
5	125-6931	1	Retainer
6	125-6976	1	Retainer
7	125-6988	1	Joint Bolt ASM
8	125-7174	1	Washer-Seal
9	125-7194	1	Bolt-Joint
10	125-7174	1	Washer-Seal
11	125-7175	2	Washer-Seal
12	125-7193	2	Gasket

Ref.	Part Number	Qty.	Description
13	125-7212	1	Bolt
14	125-7231	1	Nut
15	125-6971	1	Elbow
16	125-7077	1	Pipe
17	125-6958	1	Hose
18	125-7188	2	Clamp-Hose
19	125-7198	1	O-Ring
20	125-7208	2	Bolt
21	125-7105	4	Check Valve ASM
27	125-7098	4	Nozzle
28	125-7182	4	Pin-Spring

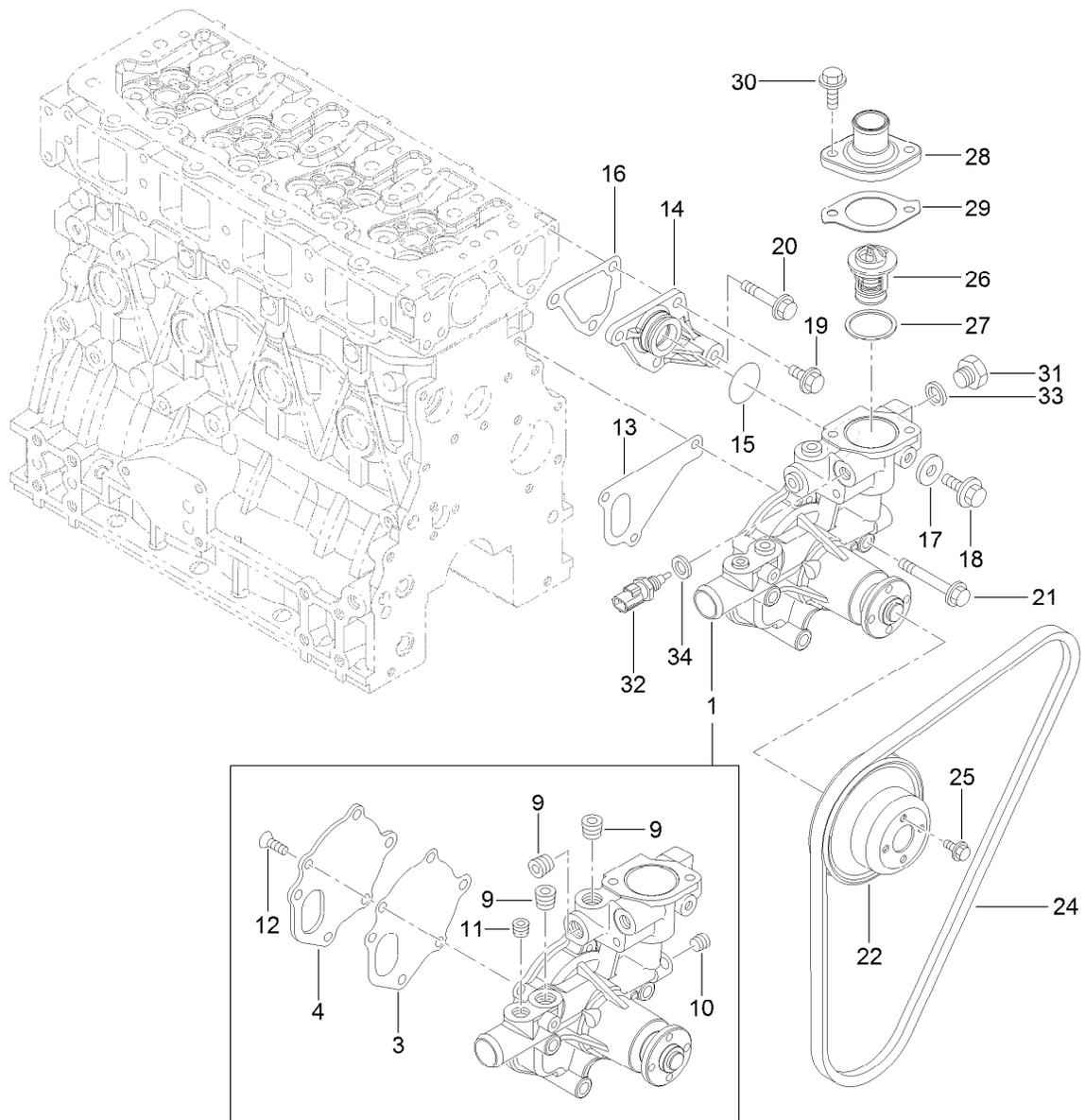

Cooling Water System Assembly

Ref.	Part Number	Qty.	Description	Ref.	Part Number	Qty.	Description
1	125-7031	1	CW Pump ASM	20	125-7219	1	Bolt
3	125-6998	1	Gasket	21	125-7222	3	Bolt
4	125-6999	1	Plate	22	125-7039	1	V-Pulley
9	125-7123	3	Plug	24	125-7204	1	V-Belt
10	125-7195	1	Plug	25	125-7206	4	Bolt
11	125-7196	1	Plug	26	125-7029	1	Thermostat
12	125-7234	3	Screw	27	125-7026	1	Gasket
13	125-7047	1	Gasket	28	125-7034	1	Cover
14	125-6986	1	Joint	29	125-7110	1	Gasket
15	125-7048	1	O-Ring	30	125-7594	2	Bolt
16	125-6978	1	Gasket	31	125-6953	1	Plug
17	125-7192	1	Gasket	32	125-7124	1	Sensor-Thermostat, CW
18	125-7212	1	Bolt	33	125-6979	1	Gasket
19	125-7214	3	Bolt	34	125-7176	1	Washer-Seal

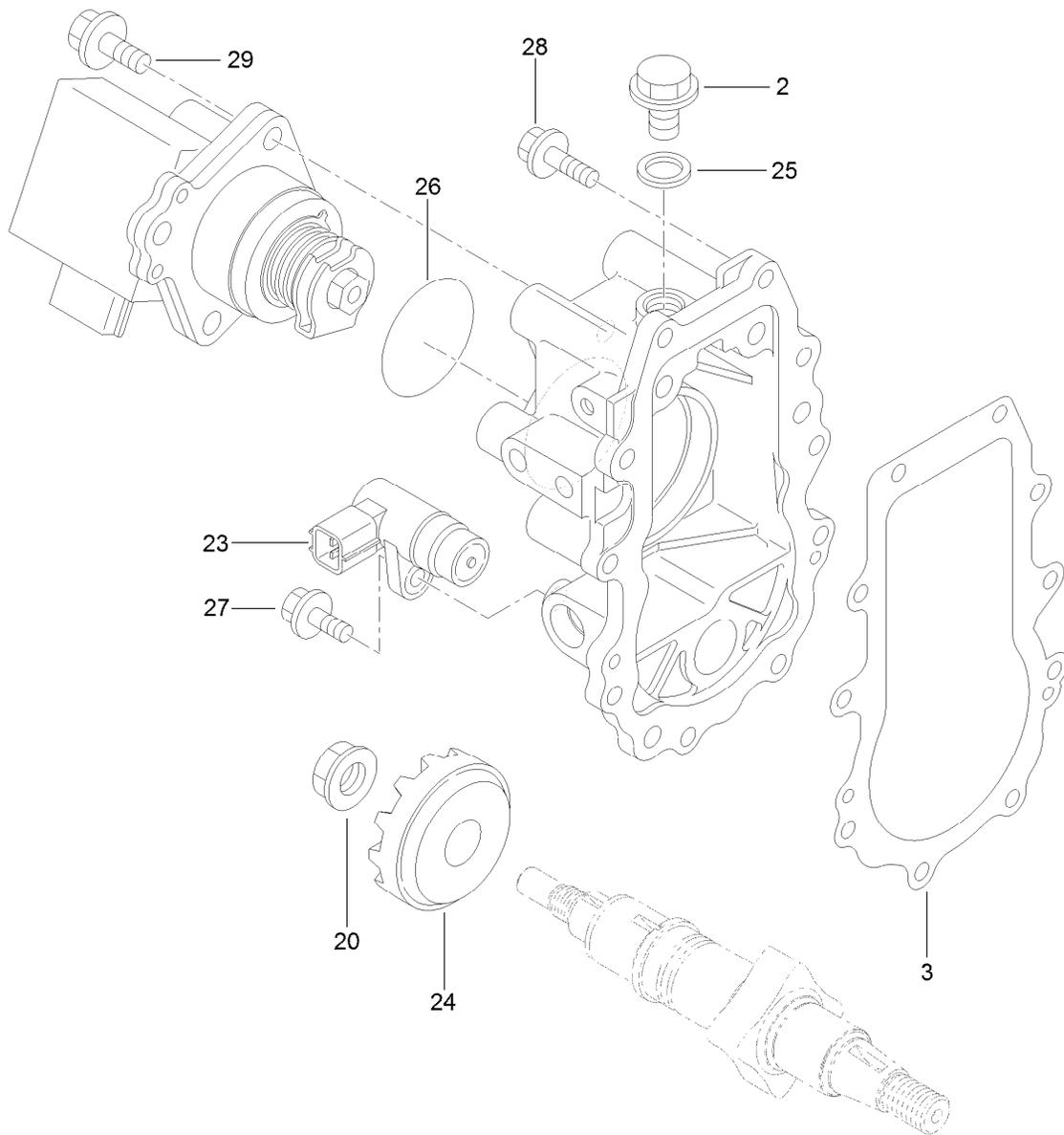

Governor Assembly

<i>Ref.</i>	<i>Part Number</i>	<i>Qty.</i>	<i>Description</i>
2	125-7148	1	Plug
3	125-7149	1	Gasket
20	125-6993	1	Nut
23	125-7152	1	Sensor
24	125-7150	1	Gear
25	125-7176	1	Washer-Seal
26	125-7200	1	O-Ring
27	125-7208	1	Bolt
28	125-7209	10	Bolt
29	125-7215	3	Bolt

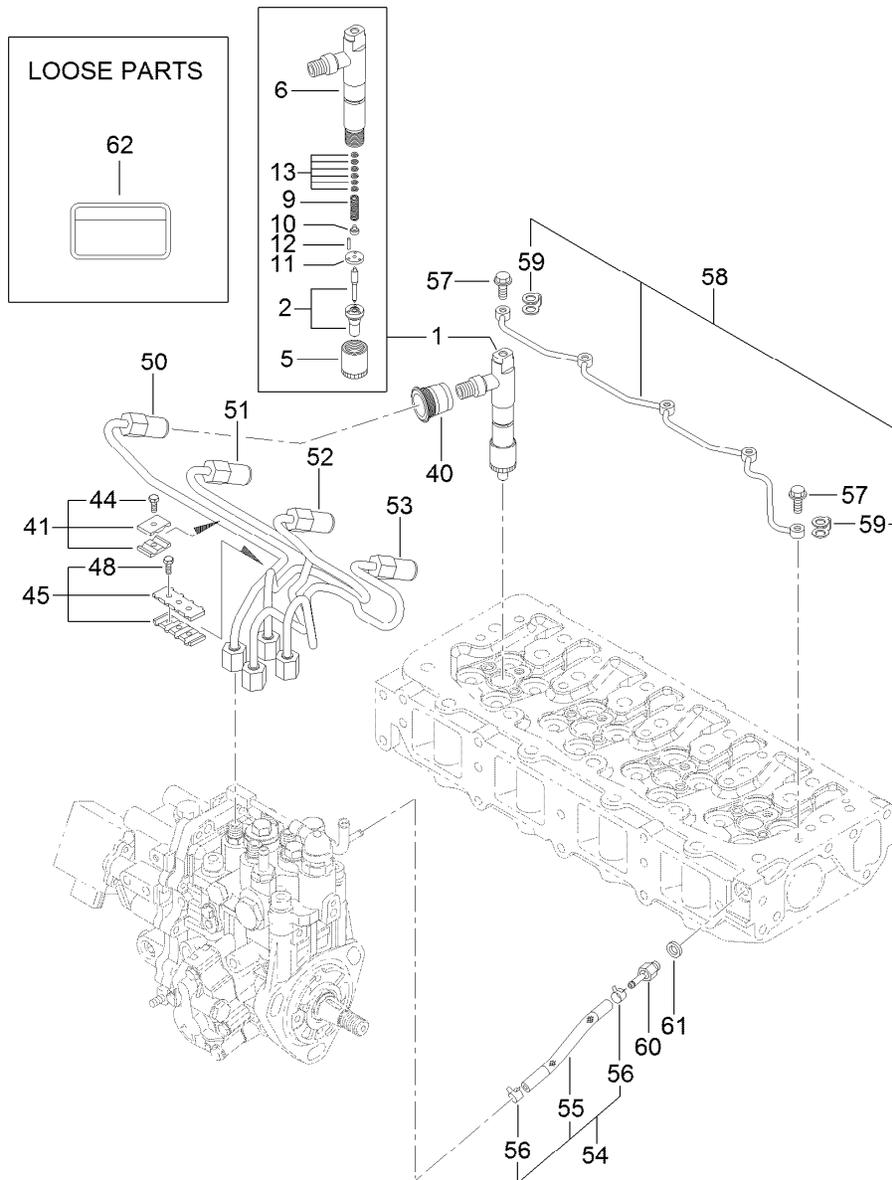

Fuel Injection Valve Assembly

Ref.	Part Number	Qty.	Description	Ref.	Part Number	Qty.	Description
1	125-7245	4	Injection Valve ASM	50	125-7082	1	Injection Pipe ASM
2	125-7133	4	Nozzle ASM	51	125-7083	1	Injection Pipe ASM
5	125-6901	4	Nut	52	125-7084	1	Injection Pipe ASM
6	125-7080	4	Holder ASM	53	125-7085	1	Injection Pipe ASM
9	125-6902	4	Spring	54	125-6948	1	Pipe ASM
10	125-6903	4	Seat-Spring	55	125-6949	1	Pipe
11	125-6904	4	Plate	56	125-6970	2	Clip
12	125-6905	8	Pin	57	125-6966	5	Bolt-Joint, Pipe
13	125-6939	4	Shim Set	58	125-7081	1	Pipe ASM
40	125-6964	4	Seal	59	125-6967	5	Gasket
41	125-6907	2	Retainer	60	125-6968	1	Joint
44	125-7027	2	Bolt	61	125-7174	1	Washer-Seal
45	125-7097	1	Retainer	62	125-6900	1	Label-Caution, Fuel Oil
48	125-7027	2	Bolt				

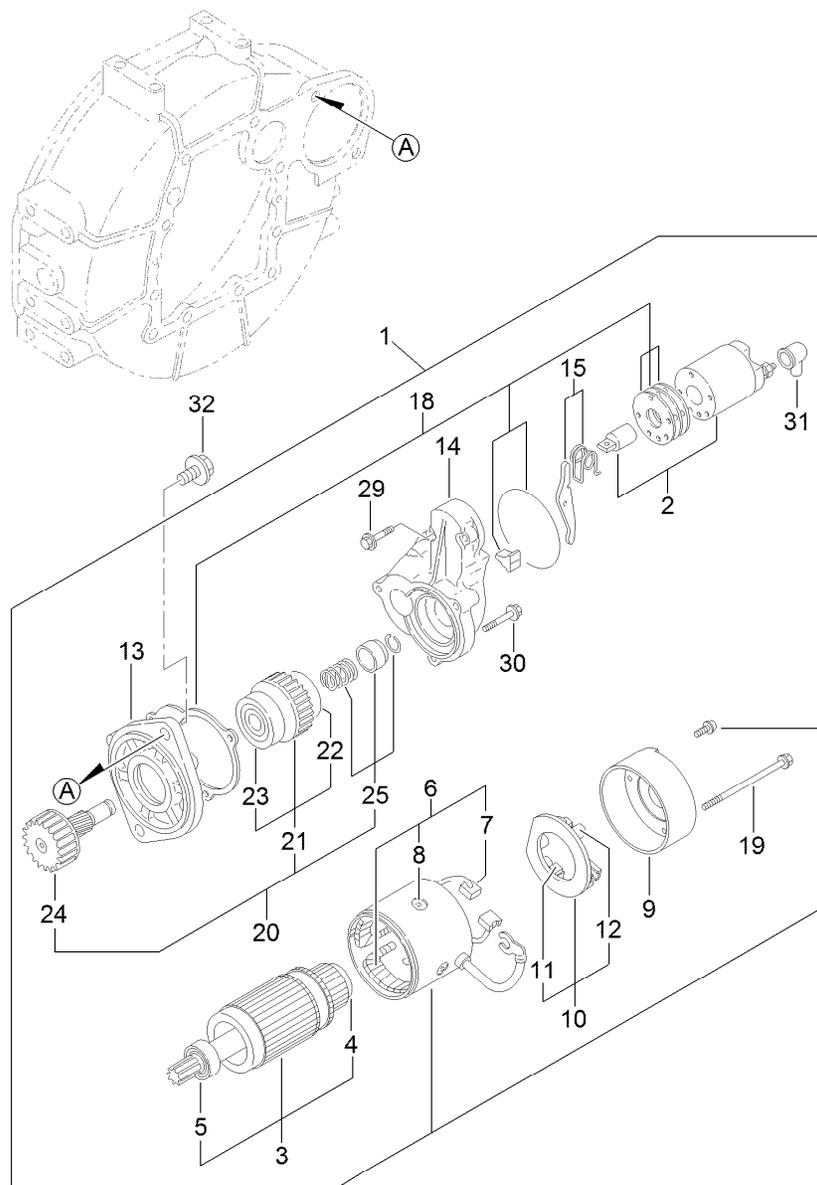

Starting Motor Assembly

<i>Ref.</i>	<i>Part Number</i>	<i>Qty.</i>	<i>Description</i>	<i>Ref.</i>	<i>Part Number</i>	<i>Qty.</i>	<i>Description</i>
1	125-7003	1	Starter	15	125-7165	1	Lever Set
2	125-7004	1	Switch ASM	18	125-7037	1	Dust Cover ASM
3	125-7112	1	Armature ASM	19	125-7117	2	Bolt-Through
4	125-7252	1	Bearing-Ball	20	125-7166	1	Pinion ASM
5	125-7249	1	Bearing, Ball	21	125-7250	1	Clutch ASM
6	125-7113	1	Field Coil ASM	22	125-7251	1	Bearing-Ball
7	125-7114	2	Brush	23	125-7253	1	Bearing-Ball
8	125-7163	4	Screw	24	125-7167	1	Shaft
9	125-7115	1	Cover	25	125-7168	1	Stopper Set
10	125-7116	1	Brush Holder ASM	29	125-7210	2	Bolt
11	125-7114	2	Brush	30	125-7211	3	Bolt
12	125-7036	4	Spring	31	125-7169	1	Cover
13	125-7164	1	Case-Gear	32	125-7225	2	Bolt
14	125-7005	1	Housing				

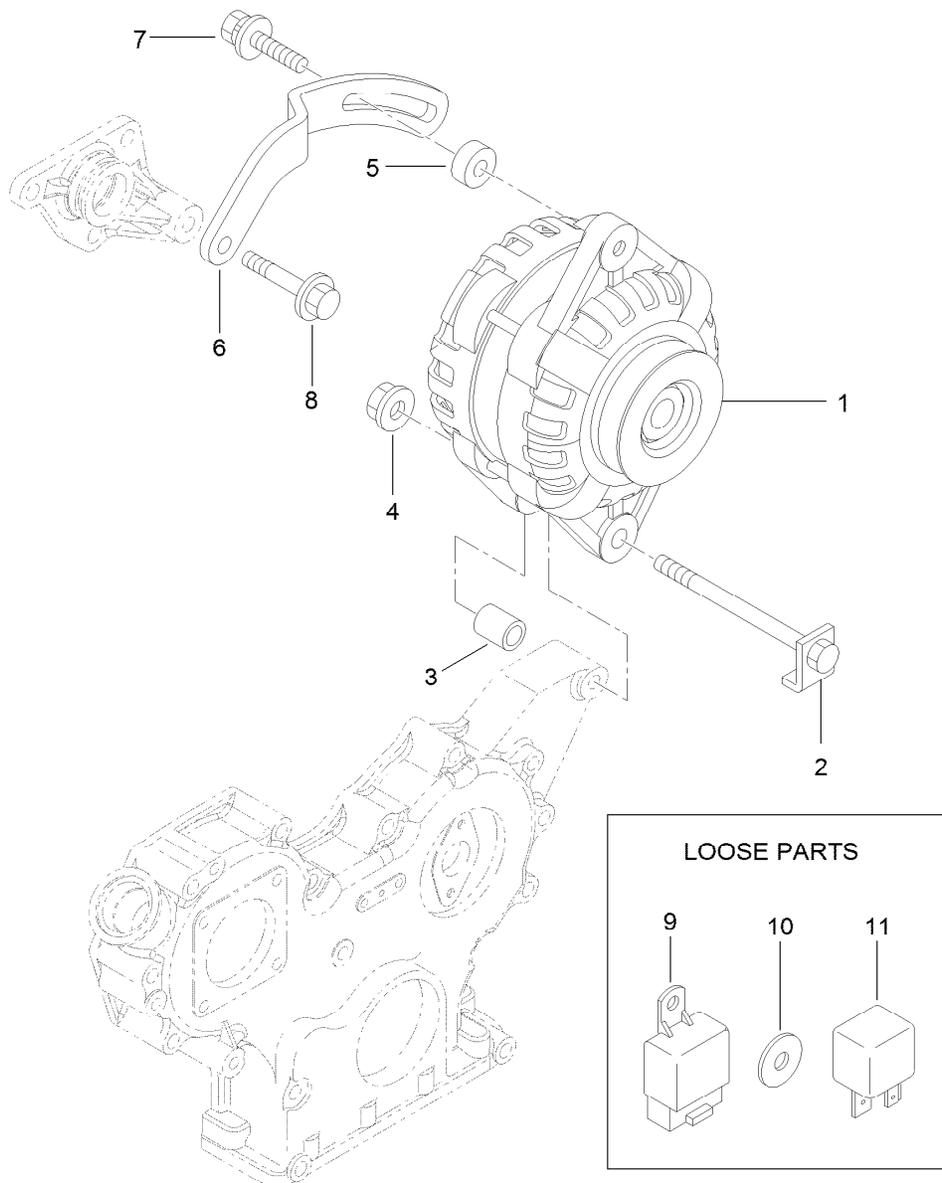

Generator Assembly

<i>Ref.</i>	<i>Part Number</i>	<i>Qty.</i>	<i>Description</i>
1	125-7120	1	Alternator-12V
2	125-7121	1	Bolt-Stopper
3	125-7122	1	Piece-Distance
4	125-7230	1	Nut
5	125-6947	1	Spacer
6	125-7101	1	Adjuster-Belt
7	125-7134	1	Bolt
8	125-7219	1	Bolt
9	125-7173	2	Relay
10	125-7131	3	Washer
11	125-7132	2	Relay

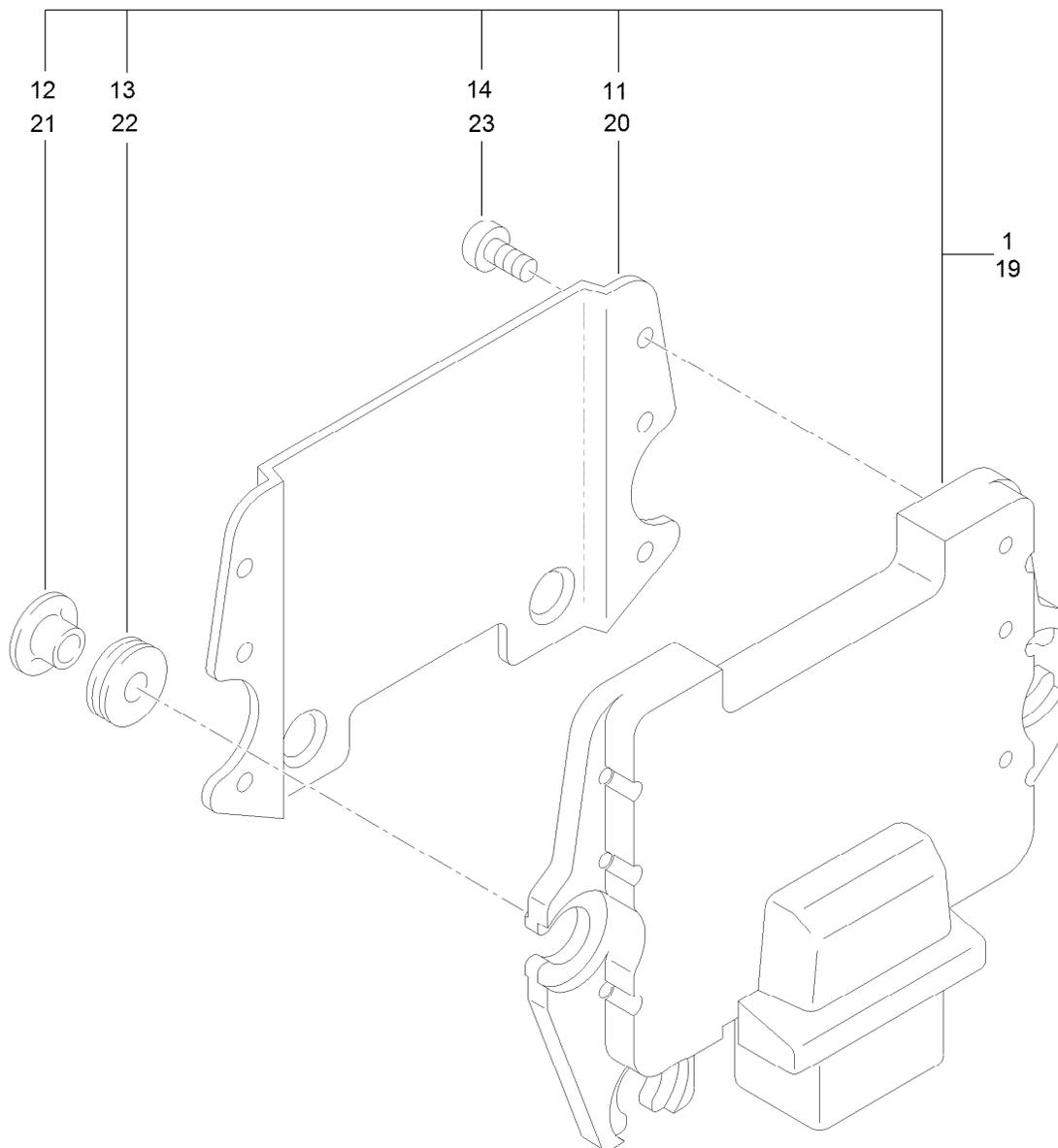

Electronic Control Unit Assembly

<i>Ref.</i>	<i>Part Number</i>	<i>Qty.</i>	<i>Description</i>
1	135-4281	1	Ecu
11	125-7129	1	Shield
12	125-7130	3	Collar
13	125-6908	3	Absorber
14	125-7187	6	Screw
19	125-7128	1	Ecu
20	125-7129	1	Shield
21	125-7130	3	Collar
22	125-6908	3	Absorber
23	125-7187	6	Screw

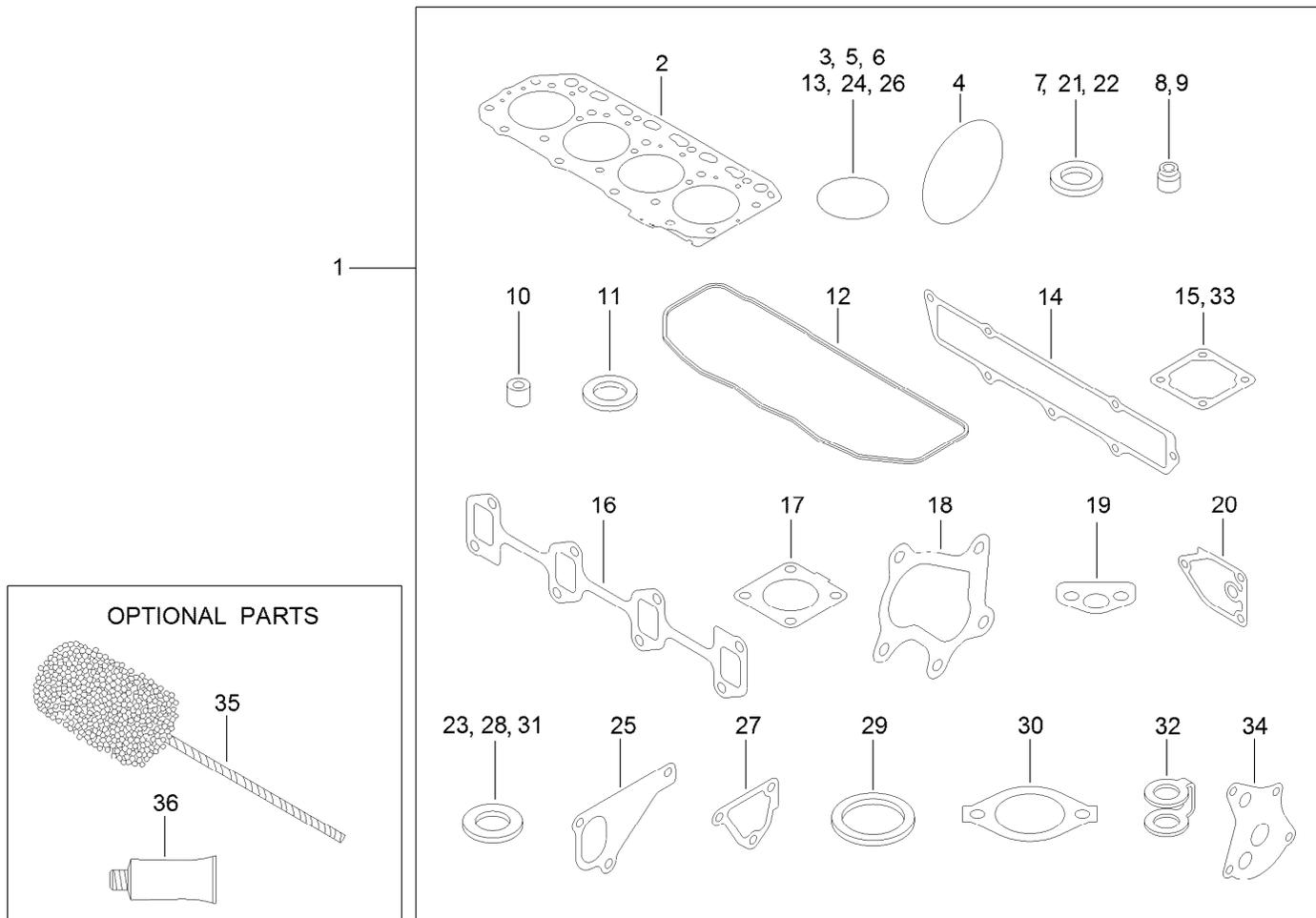

Gasket Set

Ref.	Part Number	Qty.	Description	Ref.	Part Number	Qty.	Description
1	125-7243	1	Gasket Set	19	125-7022	1	Gasket
2	125-7049	1	Gasket-Head	20	125-7024	1	Gasket
3	125-6909	2	O-Ring	21	125-7174	7	Washer-Seal
4	125-6957	1	O-Ring	22	125-7175	2	Washer-Seal
5	125-7197	2	O-Ring	23	125-7193	2	Gasket
6	125-7199	1	O-Ring	24	125-7198	1	O-Ring
7	125-7177	1	Washer-Seal	25	125-7047	1	Gasket
8	125-6915	8	Seal-Stem, Valve	26	125-7048	1	O-Ring
9	125-6916	8	Seal-Stem, Valve	27	125-6978	1	Gasket
10	125-6921	4	Protector	28	125-7192	1	Gasket
11	125-6911	4	Seat-Valve	29	125-7026	1	Gasket
12	125-7060	1	Gasket	30	125-7110	1	Gasket
13	93-0418	7	O-Ring	31	125-6979	2	Gasket
14	125-7066	1	Gasket	32	125-6967	5	Gasket
15	125-7028	1	Gasket	33	125-7000	1	Gasket
16	125-7096	1	Gasket	34	125-7021	1	Gasket
17	125-7070	1	Gasket	35	125-7038	1	Hone
18	125-7071	1	Gasket	36	125-7248	1	Gasket-Liquid

Attachments and Accessories

For 30635 Groundsmaster 4010 Rotary Mower

Product Name	Model/Part
Bumper Weight Assembly	106-4278-03
Blade-Atomic (21.75in)	107-0214-03
Atomic Blade Service Pack (7 Pack).....	108-1450
Blade-Flat Sail (21.75in)	110-6115-03
Flat Blade Service Pack (7 Pack).....	110-6130
MVP Blade Kit.....	117-2722
Backrest Extension Kit.....	119-7719
Large Seat Cover.....	120-5179
Castor Wrench.....	121-3874
Premium Engine Oil 10w30 (55 Gallon Drum)	121-6392
Premium Engine Oil 10w30 (5 Gallon Pail)	121-6393
Premium Engine Oil 15w40 (55 Gallon Drum)	121-6394
Premium Engine Oil 15w40 (5 Gallon Pail)	121-6395
Roller Assembly.....	132-6113
Pivot Caster Scraper Kit.....	132-6114
PX Hydraulic Fluid (5 Gal)	133-8086
PX Hydraulic Fluid (55 Gal).....	133-8087
Skid Plate Kit	136-4360
Blade-Rotary, Medium Sail	136-4370-03
Tire-High Traction (20x10-10).....	136-4440
Tire-High Traction (26x12-12).....	136-4442
MVP Blade Kit.....	137-5500
8in Semi-Pneumatic Wheel ASM.....	137-5529
MVP Filter Kit.....	30089
Guardian Recycler Conversion Kit.....	30420
Leaf Mulcher Kit.....	30422
CE Kit	30453
Right-Hand Replacement Mower.....	30476
Left-Hand Replacement Mower	30477
Front Deck	30479
Beacon Kit	30661
Light Adapter Kit	30691
North American Cab Light Kit, 2015 and After Groundsmaster 5910/4010/4110 Series Traction Unit	30706
Horn Kit.....	31511
Backup Alarm Kit	31512
4WD Manual Override Kit	31522
EU Light Kit.....	31543
Blade (21.75in)	92-5608-03
8in Foam Filled Wheel ASM	93-5974

Notes:

Notes:



Count on it.