



Count on it.

Software Guide

GeoLink® Global Precision Spray System Kit

Multi Pro® 1750 or 5800 Turf Sprayer

Model No. 41691

Model No. M2M-RETRO

Model No. 41713—Serial No. 323000000 and Up

Model No. 41394GK—Serial No. 400000000 and Up

Note: Software Version 5.02 and Up **Contact your authorized Toro distributor, Toro GeoLink Support at 1-844-GEOLINK (1-844-436-5465), or GeoLink@toro.com for customer service.**



Introduction

Refer to your machine *Operator's Manual* for more information.

Contents

Setup	3
1 Converting the Data	3
2 Verifying the Software Version	5
3 Adding a Vehicle	5
4 Updating the NTRIP Settings	6
5 Selecting the Units of Measure	6
6 Creating a New Product and Application Rate	7
7 Verifying the Cellular Status	9
8 Clearing the NVRAM	9
9 Calibrate the Compass	10
10 Checking the Spray System	11
11 Balancing the Agitation Bypass Valve	13
12 Calibrating the Flow Meter	14
13 Creating a Field	16
14 Creating a Boundary	17
15 Creating a Spray Task	17
Product Overview	18
Controls	20
Operation	21
Operating the Spray System of the Machine	21
Selecting a Language and Accepting the License Agreement	22
Using the Master Switch on the Control Console	22
Information, Urgent, Caution, and Warning Messages	23
Using the Inventory Manager	25
Managing Task Data	29
Managing Field Information	32
Setting the Tank Volume	40
ASC Boom Control	41
Choosing a Spraying Method	43
Configuring the Sprayer Controls for a New Task	47
MachineLink	50
Configuring Skybridge Settings	53
Technical Assistance	54
Operating Tips	57
Troubleshooting	58

Setup

1

Converting the Data

No Parts Required

Procedure

This topic explains how to convert Version 4.XX.XX legacy data using the Version 5.02.24.28 or newer Inventory Manager.

1. Place the 4.xx.xx legacy data you wish to convert into a folder labeled CLIENTS onto the root directory of a formatted USB.



Figure 1

2. Insert the USB into the console
3. Select the Inventory Manager and select External Inventory.
4. Select Convert Legacy Data from the drop-down menu.

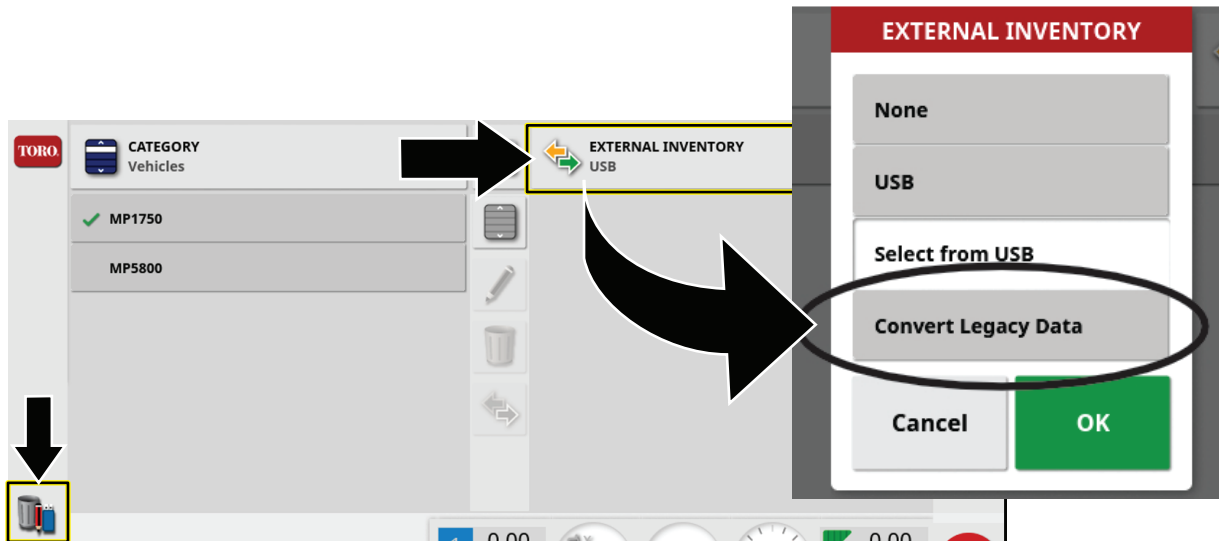

Figure 2

5. Once the console has recognized the legacy data on the USB, select OK for the data to be converted.



Figure 3

g494607

-
6. Transfer the data from the USB to the console.

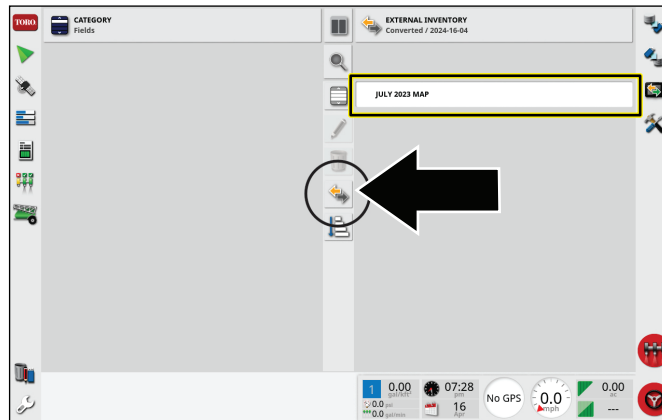

Figure 4

g494608

-
7. Once the client data has been successfully converted, you will see the green check mark window.

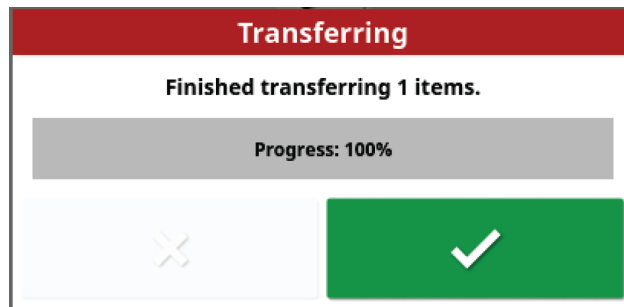

Figure 5

g494609

2

Verifying the Software Version

No Parts Required

Procedure

Contact Toro GeoLink Support for software updates.



Figure 6

g429840

3

Adding a Vehicle

No Parts Required

Procedure

- 1. Go to the SETUP menu.
- 2. Press VEHICLE then press NEW and select the vehicle you are using..

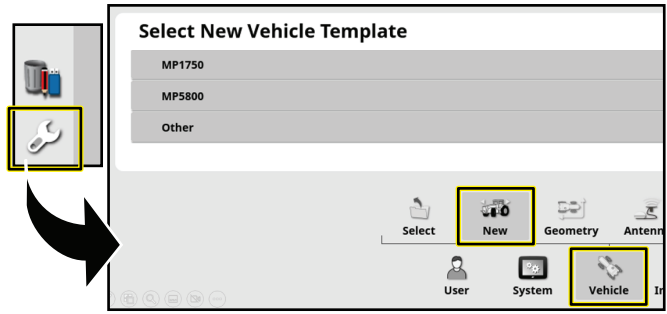

Figure 7

g442998

4

Updating the NTRIP Settings

No Parts Required

Procedure

1. Fill out the [Geolink Activation Form](https://www.toro.com/en/customer-support/contact/geolink-signup).

<https://www.toro.com/en/customer-support/contact/geolink-signup>

An auto-reply is sent to confirm the form has been submitted.

Another e-mail is sent out with the NTRIP information upon activation of the RTK subscription.
2. Navigate to NTRIP SETUP in the SETTINGS menu.
3. Enter the information provided to you in the e-mail.

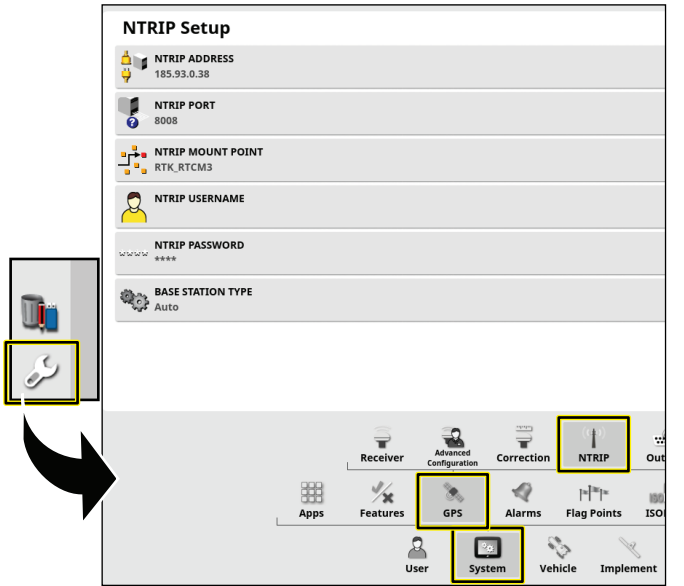

Figure 8

5

Selecting the Units of Measure

No Parts Required

Procedure

1. Press the SETUP icon on the main screen.
2. Press the USER icon.

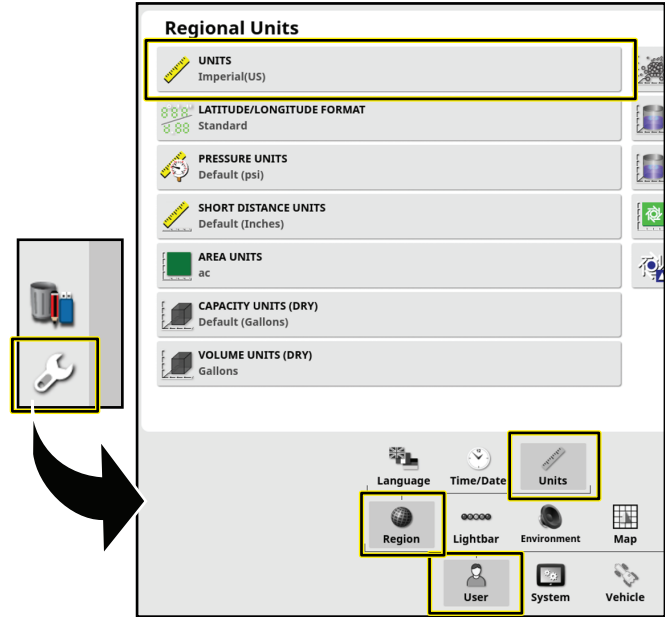

Figure 9

3. Press the REGION icon.
4. Press the UNITS icon.
5. As needed, select the desired units and application rate, and press the confirm icon.

6

Creating a New Product and Application Rate

No Parts Required

Procedure

1. Press the SPRAYER CONTROLLER icon and press the full screen icon.



Figure 10

g429984

2. Press the product icon.

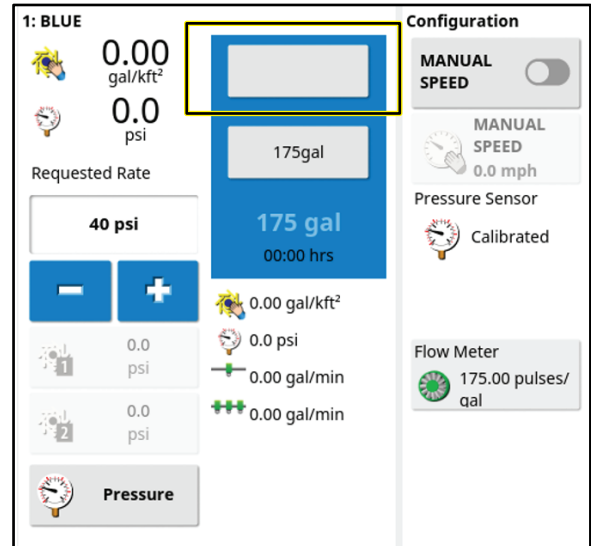

Figure 11

g429985

3. In the product configuration window, press the PRODUCT NAME icon.
4. Select NEW PRODUCT.

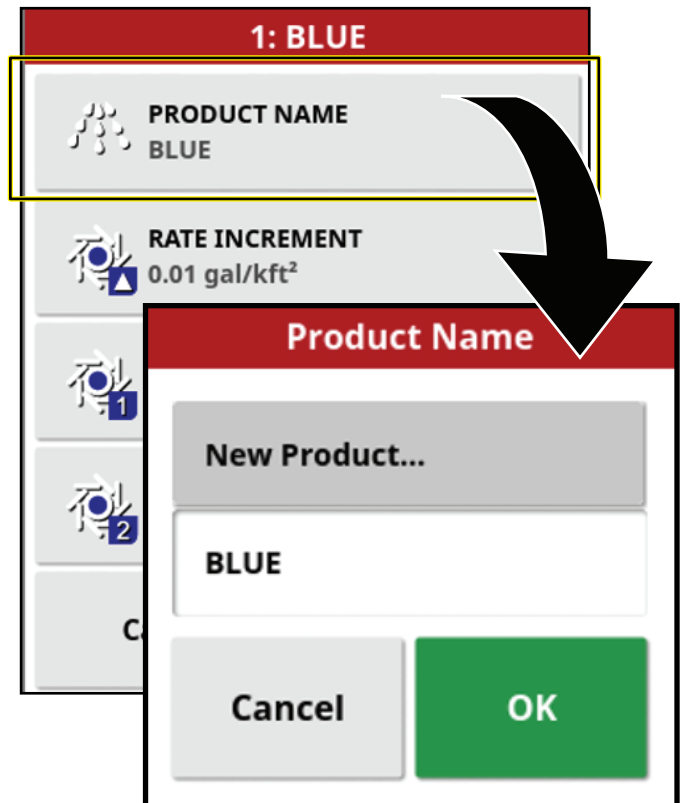

Figure 12

g429986

5. Press CUSTOM PRODUCT to name the product.

Note: Create a custom product for each nozzle color (size).

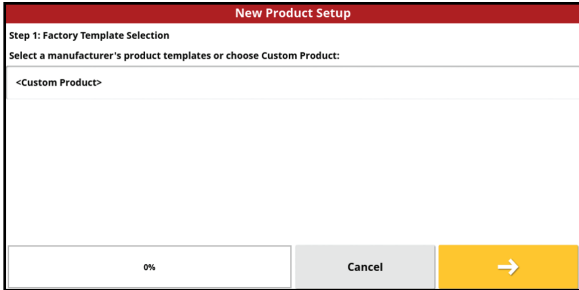

Figure 13

g429987

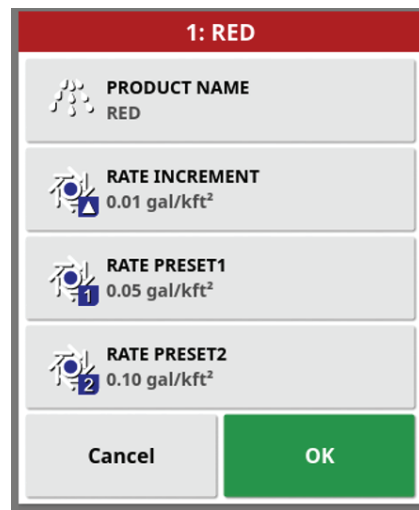

Figure 15

g429989

6. Go through the New Product wizard to set the product rate increment and preset values.

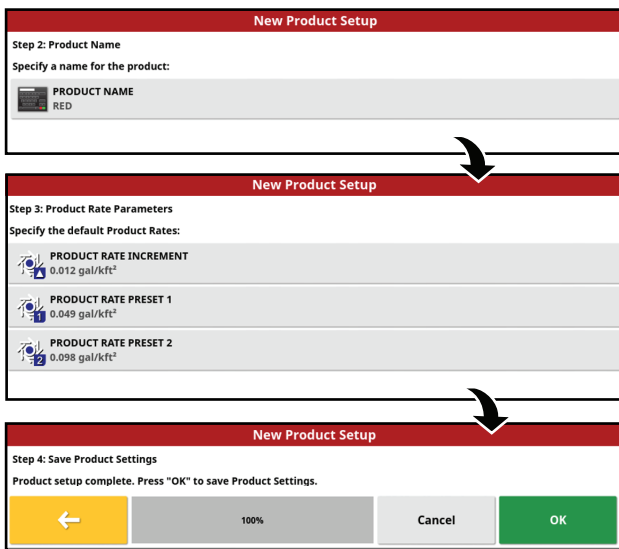

Figure 14

g429988

7. Press the confirmation box to verify the settings are correct.

7

Verifying the Cellular Status

No Parts Required

Procedure

1. Press the SYSTEM MENU icon and press the full screen icon.

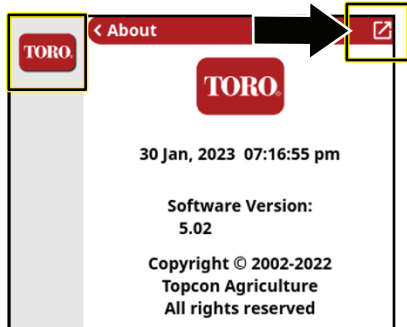

Figure 16

g431462

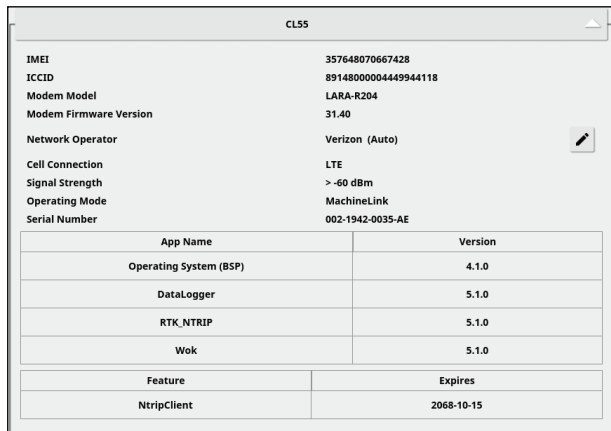

Figure 17

g431463

2. Scroll down to CL-55 to display the signal strength information and verify that the modem signal strength is between -60 dBm and -99 dBm.

Note: If the modem signal is equal to or less than -100 dBm, Contact your authorized Toro distributor or Toro GeoLink Support.

8

Clearing the NVRAM

No Parts Required

Changing the Setup Screen for Dealer Access

Note: You must clear the nonvolatile RAM at the customer location.

1. Contact Toro support to request the dealer access level password.
2. Press the SETUP icon on the main screen.
3. In the setup screen, press the USER icon and the ACCESS LEVEL icon.

Note: Switch to standard mode if the machine is in easy mode.

4. Press the PASSWORD icon
5. Use the on-screen keyboard to enter the password and press the confirm icon

Note: The user access level screen displays the DEALER icon.

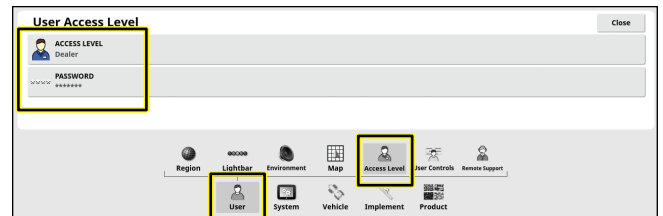

Figure 18

g431230

Erasing the Nonvolatile RAM

1. Turn the machine on.
2. In the setup screen, press the SYSTEM icon, GPS icon, and ADVANCED CONFIGURATION icon

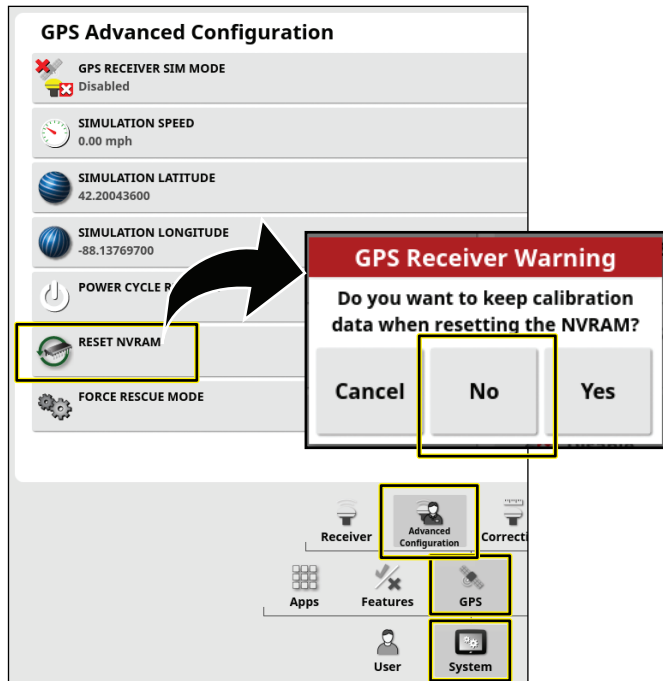

Figure 19

g431231

3. In the GPS Advanced Configuration screen, press the RESET NVRAM icon
4. In the GPS receive warning dialog box, press the No icon

Note: The receiver disconnected warning displays briefly.

5. Wait 2 minutes for the satellite receiver and modem startup.
6. Press the CLOSE icon.

9

Calibrate the Compass

No Parts Required

Procedure

1. Press the RECEIVER CALIBRATION icon.
2. Press the COMPASS icon.

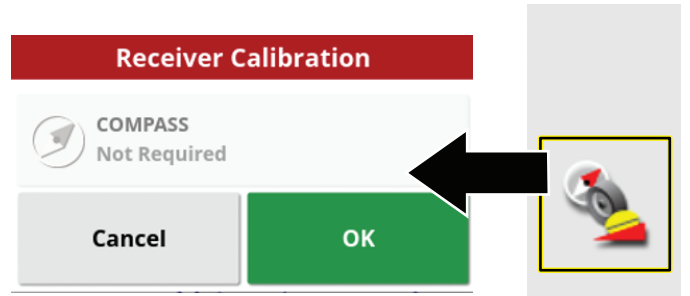

Figure 20

g446888

3. Drive the machine 1–1/2 revolutions in a circle that is **at least** 6 m (20 ft) diameter.
4. Press the next icon.
5. Drive straight for 92 m (100 yd).

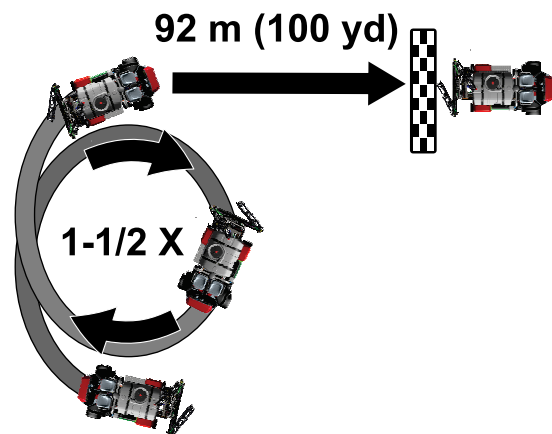

Figure 21

g209126

6. Check the display for the compass calibration confirmation message.

10

Checking the Spray System

No Parts Required

Procedure

Note: The self-test feature simulates machine ground speed so that you can test the system without moving. This feature clears itself when the speed sensor detects that the vehicle is in motion. The self-test feature of the GeoLink system serves the similar function as the test speed feature of the Multi Pro 1750 and Multi Pro 5800 machines.

1. Engage the parking brake.
2. Add 200 L (50 US gallon) of water into the spray tank; refer to the *Operator's Manual* for your machine.
3. Start the engine and set the engine speed to fast.
4. On the display, press the SPRAY RATE CONTROLLER icon.
5. In the spray rate controller dialog box, select PRESSURE mode.
6. Adjust the spray system pressure to 8.27 bar (120 psi).

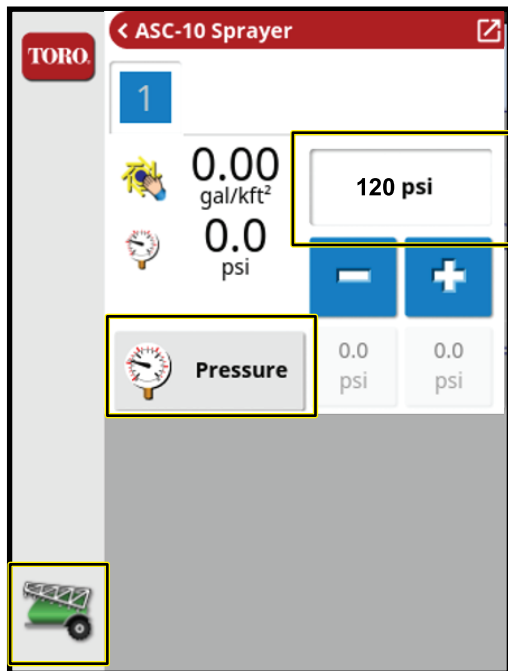



Figure 22

g448366

7. On the machine, turn the pump and master section switch to the ON position.
8. On the display, turn the MASTER SWITCH icon to ON (green) .
9. On the display, press the ASC icon and turn the ASC OFF.

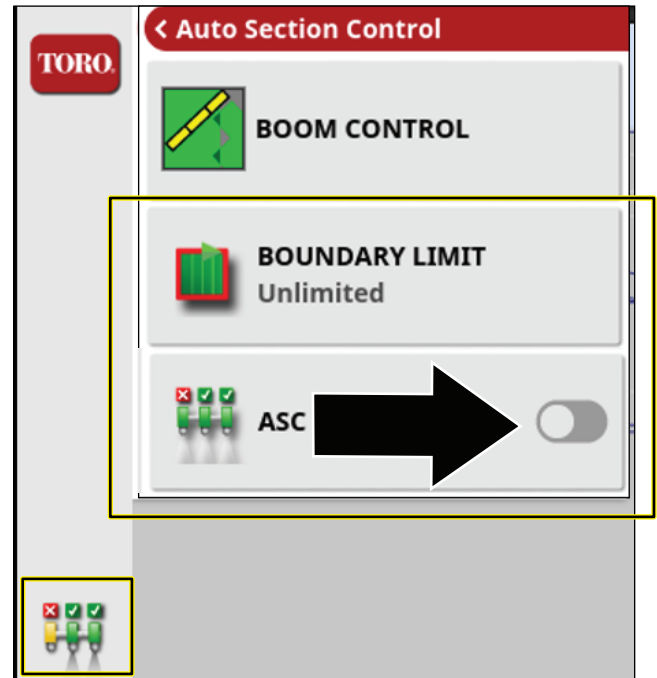

Figure 23

g431464

10. Press the sprayer-controller icon.
11. Press the full screen icon in the sprayer controller menu.

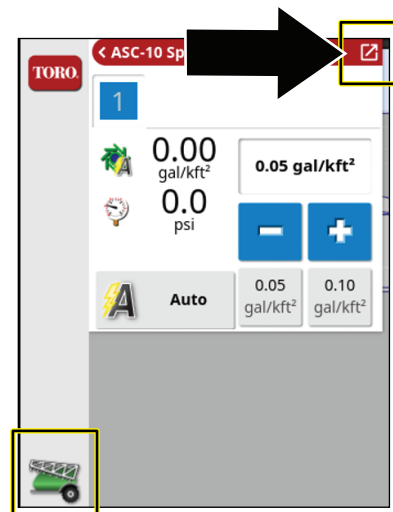

Figure 24

g431472

12. Press the configuration icon in the sprayer controller submenu to display the configuration menu.

Note: If you find any leaks, shut off the engine and repair the fitting or component.

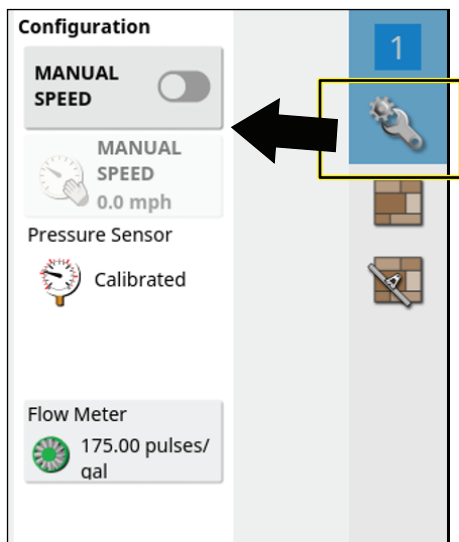

Figure 25

g431471

13. Press the MANUAL SPEED icon.

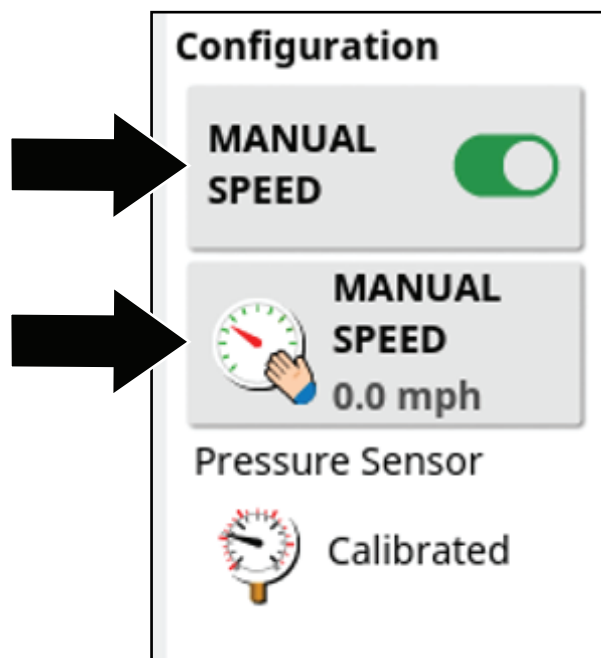

Figure 26

g430985

14. Enter the simulated speed.
15. Press the full screen icon to return sprayer controller menu.
16. Enter the desired application rate by using the pre-sets, increase or decrease icons, or by selecting the current-target application rate icon.
17. Check all sprayer fittings and components for leaks.

11

Balancing the Agitation Bypass Valve

No Parts Required

Checking System and Agitation Bypass Pressure

1. Engage the parking brake, start the engine, set the throttle to the mid range.
Note: Allow the engine and hydraulic system to warm for 10 minutes.
2. Ensure that the master section switch to the OFF position  .
3. Set the spray-pump switch and the tank agitation switch to the ON position.
4. Set the left, center, and right section switches to the ON position.
5. Set the engine speed to fast.
6. On the display, press the SPRAY RATE CONTROLLER icon.
7. In the spray rate controller dialog box, press the RATE CONTROL MODE icon until PRESSURE mode displays.
8. Press the decrement icon (-) or increment icon (+) to adjust the spray system pressure to 6.9 bar (100 psi).

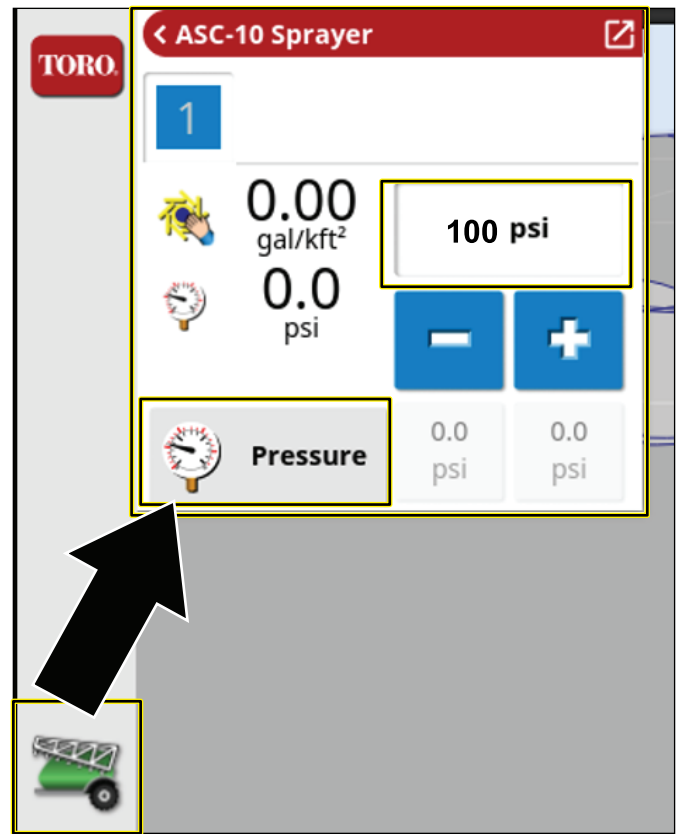

Figure 27

g446899

9. On the machine, set the tank agitation switch to the OFF position.
10. Observe the spray system pressure. If the spray system pressure is 6.9 bar (100 psi), the agitation valve is correctly adjusted.
11. If the spray system pressure changed, adjust the agitation bypass valve; refer to your *Operator's Manual*.

12

Calibrating the Flow Meter

No Parts Required

Preparing for the Calibration

Customer provided equipment:

- A graduated catch container (graduated in 0.01 ml (1/2 fl. oz) increments is preferred)
- A stopwatch capable of measuring $\pm 1/10$ second.
 1. Ensure that the sprayer tank is clean.
 2. Fill the sprayer tank with at least 150 gallons of fresh water.
 3. Ensure that the nozzles that you intend to test are in the active spray (down) position.
 4. Engage the parking brake and start the engine.

Note: Allow the engine and hydraulic system to warm for 10 minutes.

Performing the Pretest Priming

1. On the command console, press the SPRAY RATE CONTROLLER icon.
2. Set the rate controller to PRESSURE MODE.

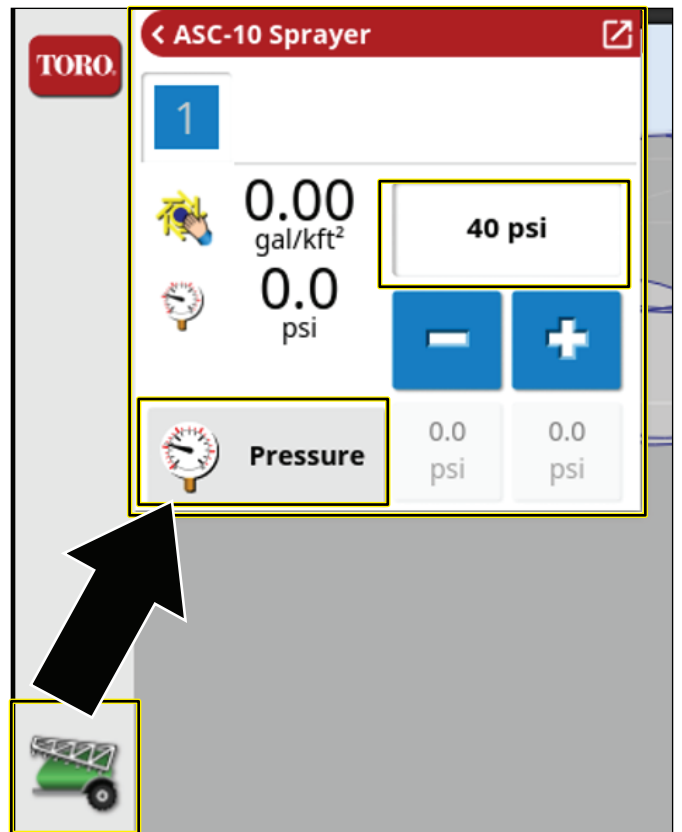



Figure 28

g435476

3. On the machine, set the sprayer pump switch to the ON position; refer to [Operating the Spray System of the Machine \(page 21\)](#).
4. Set all the 3 spray section switches to the ON position.
5. Set the throttle to the FAST position.
6. On the display, press the MASTER SWITCH icon .
7. On the machine, set the master section switch to the ON position.
8. Set the pressure to 2.75 bar (40 psi).
9. On the machine, set the master section switch to the OFF position.

Running the Catch Test and Entering the Information

1. On the machine, set the throttle to the FAST position.
Allow the spray pressure to stabilize.
2. Ensure that the 3 spray section switches are in the ON position.

3. In the control console, ensure that the MASTER SWITCH icon indicates green (system ready)



4. Press the FLOW METER icon.

Note: The auto flow calibration wizard displays.

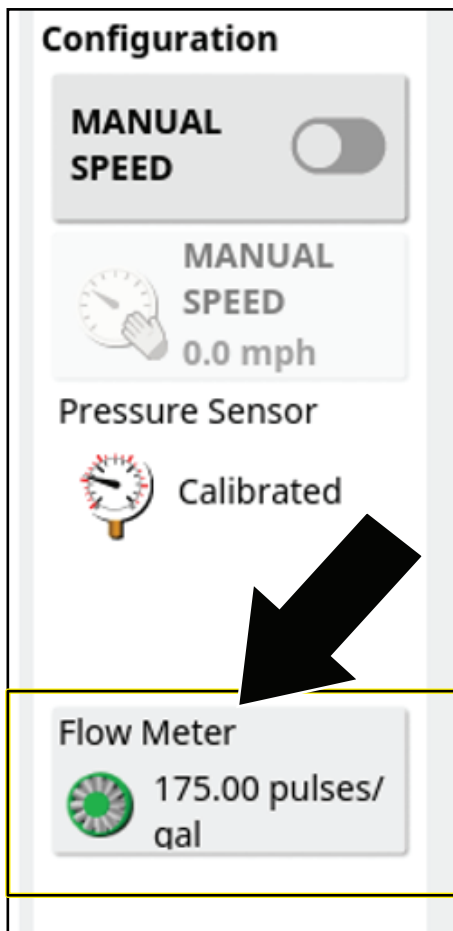

Figure 29

g430702

Performing the 15-Second Catch Test

Auto Flow Calculation Steps 1 and 2

1. In step 1 of 4 of the auto flow calibration wizard, press the next button.
2. On the machine, set the master section switch to the ON position.

Note: The pulse counter, time counter, and estimated volume counter run.

3. Move to the back of the machine, place the catch container under 1 of the end nozzles, and start the stopwatch.

Important: Ensure the catch container is collecting fluid from only 1 nozzle.

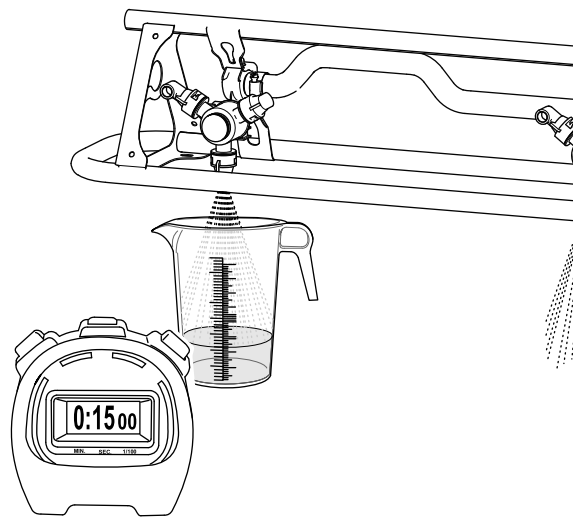

Figure 30

g306656

4. At 15-seconds, remove the catch container from the nozzle, and move to the operator's seat.
5. On the control console in step 2 of 4 in the auto flow calibration wizard, when the time counter reaches 60-seconds—set the master section switch of the machine to the OFF position.

Note: The pulse counter and estimated volume counter stop. The time counter runs until you move to step 3 of 4 in the auto flow calibration wizard.

6. Set the throttle to the slow position, and shut off the spray pump.
7. In step 2 of 4 in the auto flow calibration wizard, press the next icon.

Calculating the 60-Second Sprayer Volume

1. Set the graduated container on a level surface, allow the fluid to settle, and note the fluid volume

Important: Ensure that the graduated container is on a level surface.

Small errors reading the fluid volume in the graduated container will significantly impact the accuracy of the sprayer calibration.

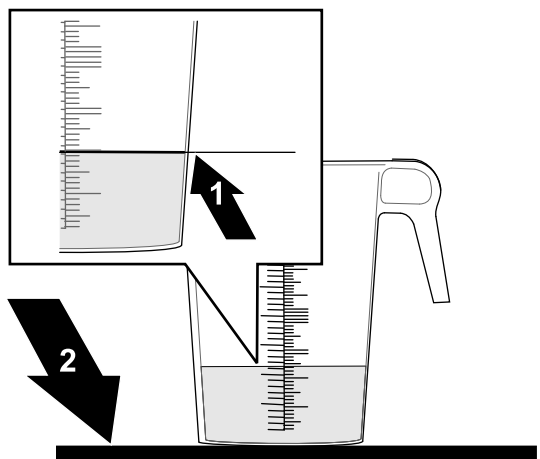

Figure 31

g306657

1. Fluid level
2. Level surface

2. Using the fluid amount collected from the 1 nozzle, multiply 12 (the number of nozzles), to calculate the 15-second sprayer volume.

Step 1 Measurement		15-Second Sprayer Volume
(ml or oz)	x 12 =	(ml or oz)

Example: 44 fl oz X 12 nozzles = 528 fl oz

3. Multiple the 15-second sprayer volume that you calculated in step 2 by 4 to calculate the 60-second sprayer volume.

15-Second Sprayer Volume		60-Second Sprayer Volume
(ml or oz)	x 4 =	(ml or oz)

Example: 528 fl oz X 4 = 2112 fl oz

4. Convert that 60-second sprayer volume into liters or gallons (33.8 oz equals 1 liter; 128 fl oz equals 1 US gallon).

Record the converted volume here:
 _____ (L or US gal).

Example: 2112 fl oz / 128 = 16.5 US gal

Entering the Converted 60-second Sprayer Volume

Auto Flow Calculation Steps 3 and 4

1. In step 3 of 4 in the auto flow calibration wizard, press the VOLUME CAPTURED icon, enter the fluid volume that you converted above with the on-screen keypad, and press the confirm icon.
2. Press the next icon.
3. In step 4 of 4 in the auto flow calibration wizard, press the confirm icon.

The 'pulses/gal' should be less than 400. If the value is higher, run the test again.

13

Creating a Field

No Parts Required

Procedure

Note: Create 1 field per course with all field boundaries for that course within that field.

1. Press the FIELD MENU icon, and press the NEW FIELD icon.

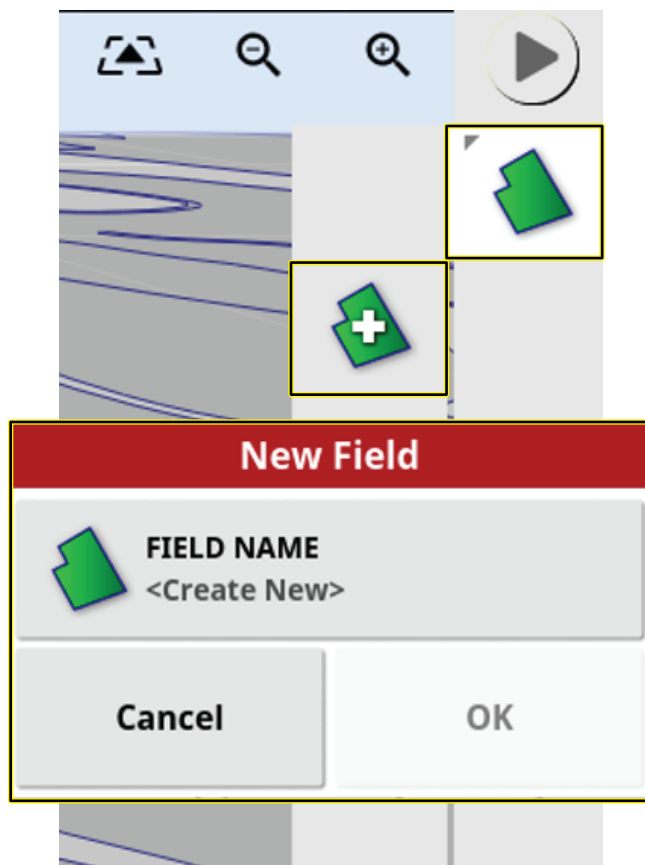

Figure 32

g429983

2. Press the FIELD NAME icon.
3. Enter the field name with the on-screen keyboard, and press the confirm icon.
4. In the new field dialog box, press the confirm icon.

Note: The new field becomes the active field.

14

Creating a Boundary

No Parts Required

Procedure

Refer to [Recording a Field Boundary](#) (page 32).

15

Creating a Spray Task

No Parts Required

Procedure

A spray task only relates with 1 field. A spray task cannot spray boundaries between multiple fields.

1. Press the TASK MENU icon and then the CREATE TASK icon.

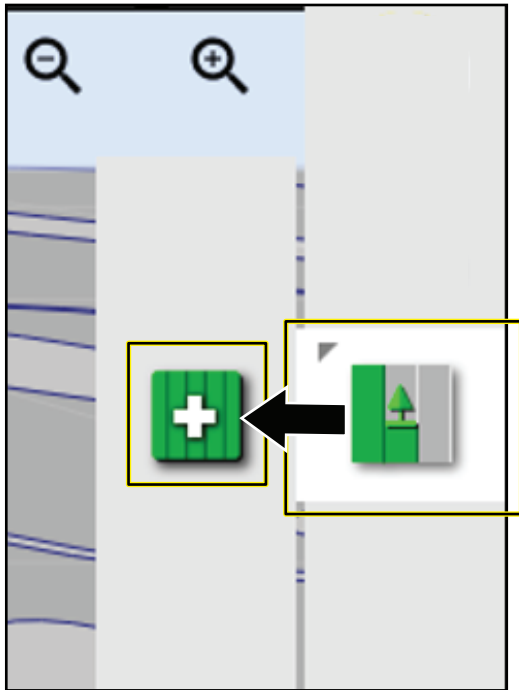

Figure 33

g430287

2. In the new task window:
 - A. Select TASK NAME to update the new task name (optional).

A screenshot of the "New Task" dialog box. The dialog has a red header with the text "New Task". Below the header are several input fields: "TASK NAME" with the value "MP1750 20230130", "Field" with the value "TORO CC" and a plus icon, "NOZZLE" with the value "None Selected", and "TASK REGIONS" with a plus icon. At the bottom are "Cancel" and "OK" buttons.

Figure 34

g430288

- B. Choose a field or create a new one.
Note: It will default to the active field.
- C. Select a nozzle.
- D. Configure the task region; refer to [Configuring a New Task Region](#) (page 29).

Product Overview

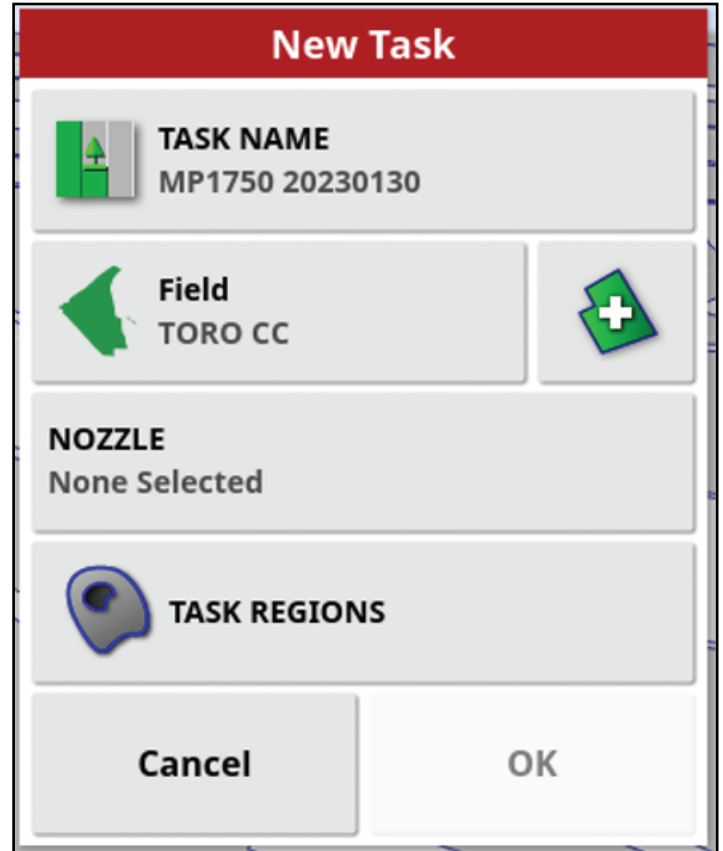
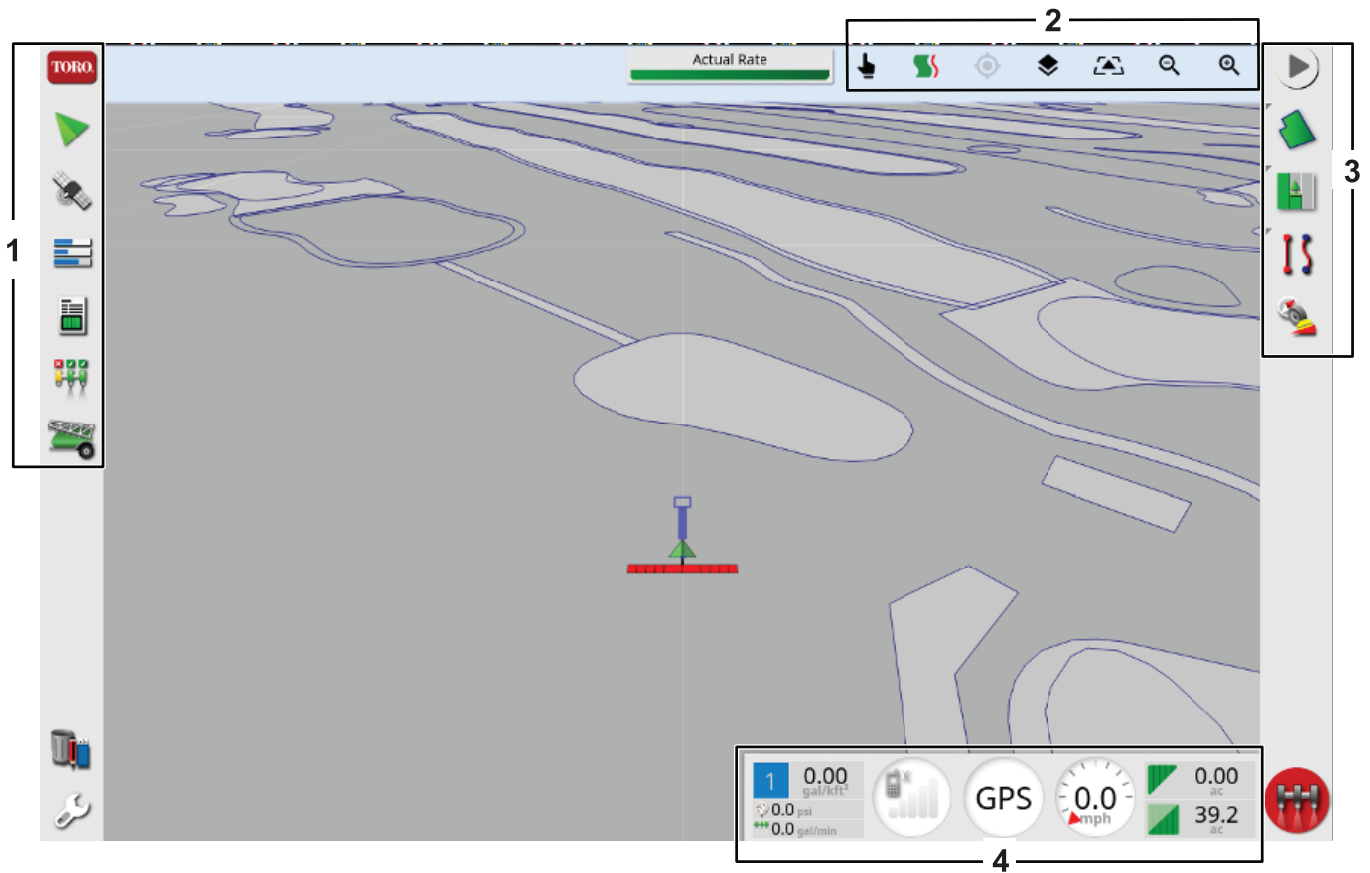
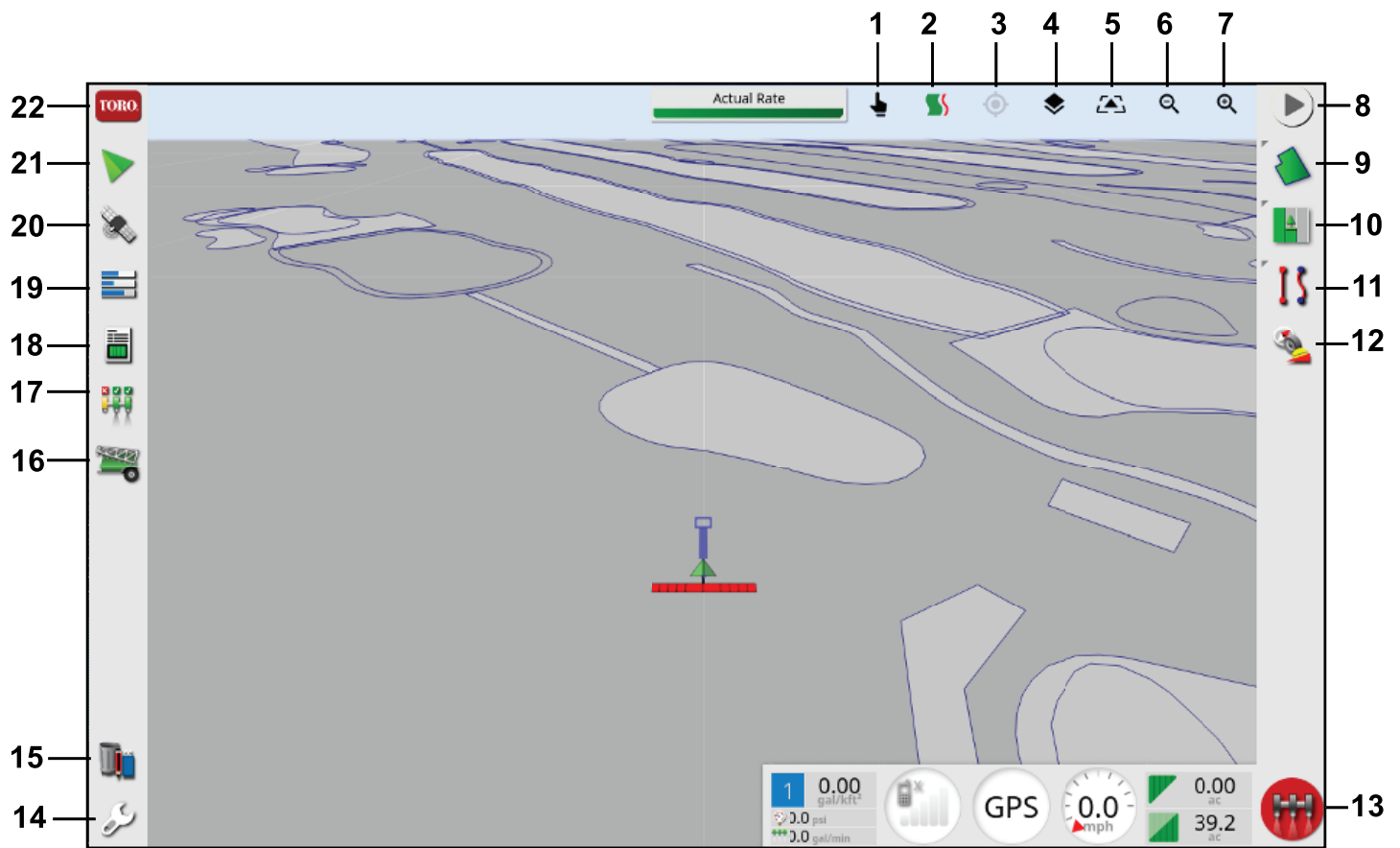

Figure 35

g431529

1. Navigation toolbar
2. View controls
3. Guidance toolbar
4. Dashboard



g429991

Figure 36

- | | |
|-----------------------------------------------------------------|----------------------------------|
| 1. Boundary select | 12. Compass/Receiver calibration |
| 2. Guidelock | 13. Master switch |
| 3. Re-center | 14. Setup |
| 4. Map layers | 15. Inventory manager |
| 5. Display view | 16. Sprayer menu |
| 6. Zoom out | 17. Auto Section Control (ASC) |
| 7. Zoom in | 18. Task information |
| 8. Task options | 19. Console menu |
| 9. Field menu | 20. GPS menu |
| 10. Task menu | 21. Guidance menu |
| 11. Guideline menu (expert mode for use with the AutoSteer kit) | 22. System information menu |

Controls

Select anywhere on the dashboard to customize what is shown.



Figure 37
Dashboard











g435461

Swipe up from the bottom of the screen to access this control panel.



Figure 38

g430723

Icon	Icon Description	Icon	Icon Description
	Turns the display off and on.		Press this icon to view screen layout options.
	Displays the name of each icon. A question mark will display next to each icon. Touch an icon to see the icon name.		Press this icon to see the list of saved global home screens or to toggle between saved screens.
	Press this icon before removing the USB from the display.		Lowens the brightness of the screen
	Press this icon to take a screenshot.		Brightens the screen
	Press this icon to capture a video.		Press this icon to choose between day, night (dark), and auto display options. Auto mode will set the display option automatically, depending on the light conditions.

Operation

The computer in the automatic section controller (ASC) controls the spray application rate for varying vehicle speeds. You set the target volume per unit area to spray, and the ASC automatically maintains the flow within the proper range of the vehicle speed and continually displays the actual volume of material per area sprayed. The X console also monitors the area sprayed, the speed of the vehicle, and the total volume of material sprayed.

Note: Ensure that the sprayer is calibrated correctly before starting to spray.

Note: Ensure that the InfoCenter is set to GeoLink before using the display to spray.

Operating the Spray System of the Machine

1. Set the 3 section switches (located in the control console of the machine) to the ON position.

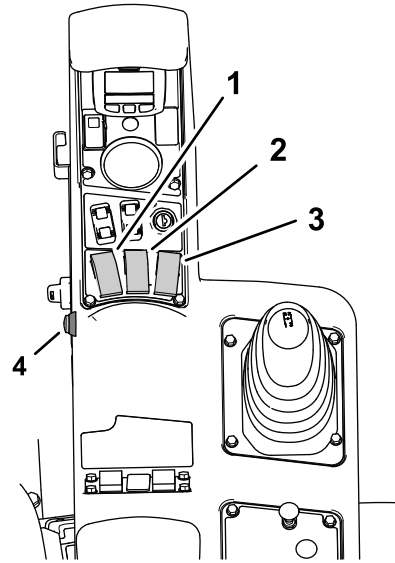

g305273

Figure 39
Multi-Pro 1750

- | | |
|--------------------------|--------------------------|
| 1. Left section switch | 3. Right section switch |
| 2. Center section switch | 4. Master section switch |

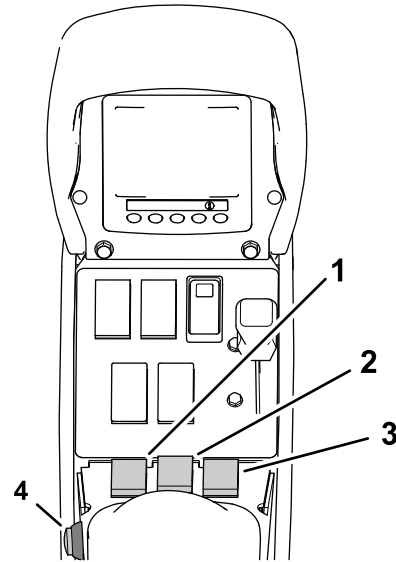

g305272

Figure 40
Multi-Pro 5800

- | | |
|--------------------------|--------------------------|
| 1. Left section switch | 3. Right section switch |
| 2. Center section switch | 4. Master section switch |

2. Press the master-section switch on the machine.

3. Press the master-switch icon in the control-console display (Multi Pro 5800 turf sprayers only).
4. Drive into the spray area.

Note: The machine starts spraying when the sprayer crosses into the defined spray area with the ASC control mode set the FIELD BOUNDARY position.

Note: The display shows areas you will spray as light gray and non-spray areas as dark gray. If the display shows all light gray, you can spray every area.

Selecting a Language and Accepting the License Agreement

The screen that follows the splash screen displays the language selection and the EULA (end user license agreement).

1. If needed, press the languages icon to change the display to a different language.

Note: Setting the language in the EULA screen changes the language setting throughout the user interface. You can also change the language in the User settings.

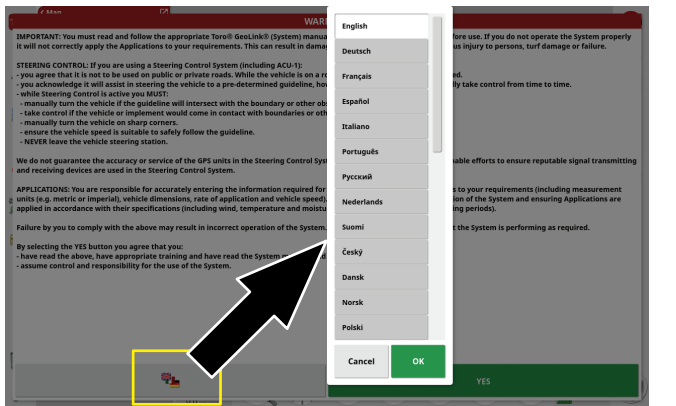

Figure 41

2. Read the EULA.
Use the scroll bar to navigate to the bottom of the screen. The YES icon will change to green.
3. Press the YES icon to move to the home screen.

Using the Master Switch on the Control Console

Note: The master switch is connected to the task button. Select or create a task to enable to master switch; refer to [Understanding the Task Button \(page 29\)](#).

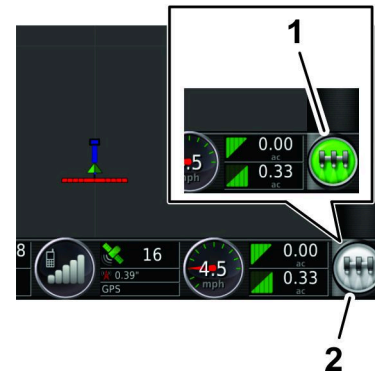

Figure 42

1. Green MASTER SWITCH icon (system ready, sprayer controller enabled)
2. White MASTER SWITCH icon (standby)

g203807

The MASTER SWITCH icon indicates the readiness of the system by the following colors:

- Green—indicates that the system is ready, and the sprayer controller is enabled and able to spray.
- White—sprayer controller is in standby.
- Red—indicates that the system is not ready, the sprayer controller is disabled and unable to spray.

When the MASTER SWITCH icon is red, press the icon to display the master switch status dialog box, which shows the number of active alarms.

At any time, press the confirm icon to return to the main screen and complete the necessary corrective action.

Using the Master Switch Multi Pro 1750 Turf Sprayer

The MASTER SWITCH icon on the home screen indicates the sprayer system is on or off.



Using the Master Switch Multi Pro 5800 Turf Sprayer

The MASTER SWITCH icon on the home screen turns the sprayer system on or off. This switch does not work if the master-section switch or the left, center, and right section switches of the machine are in the OFF position; refer to the *Operator's Manual* for information about the master-section switch and the 3 section switches.

- Press the MASTER SWITCH icon to run the sprayer system (the icon turns green).
- Press the MASTER SWITCH icon to shut off the sprayer system (the icon turns white).

Information, Urgent, Caution, and Warning Messages

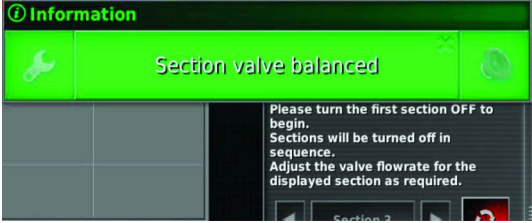
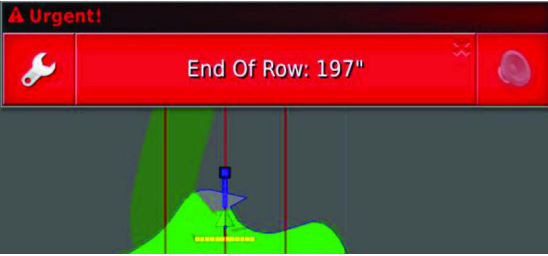
Messages table

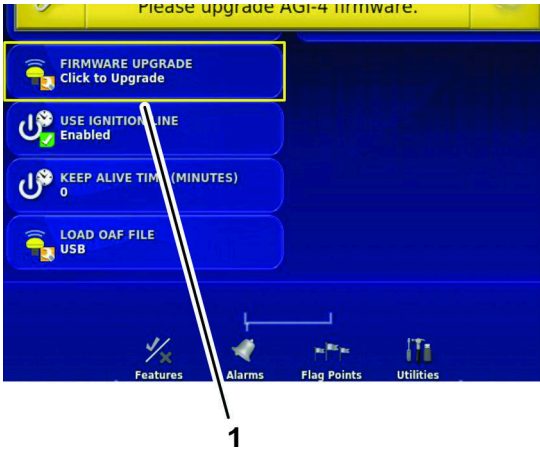
	<p>Information messages tell you the status of a process.</p>
	<p>Urgent messages tell you that you need to act.</p>
 <p>1. SETTINGS LINK icon 2. CLOSE icon 3. ALARM AUDIO SHUTOFF icon</p>	
 <p>1. Icon linked to the settings-menu screen</p>	<p>Caution messages tell you that you should to perform a corrective action before operating the machine.</p>

Messages table (cont'd.)

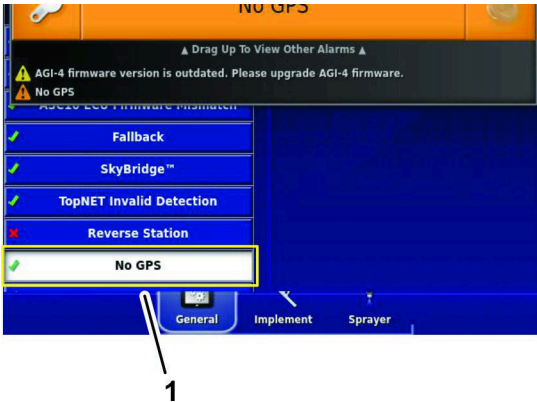
 <p>1. Corrective action information 2. Details icon (swipe down) 3. Message details</p>	<p>Warning messages tell you that you must to perform a corrective action before operating the machine.</p>
 <p>1. Linked to the settings-menu screen</p>	

Using the Inventory Manager

USB Storage Device Specification

- USB 3.0
- 8 GB or larger
- Linux compatible

Using a USB Storage Device

1. Insert a USB storage device into the USB port.
2. Save or transfer information to and from the USB storage device using the inventory manager.
3. At the bottom of the control console screen, swipe up to access the floating-menu bar.

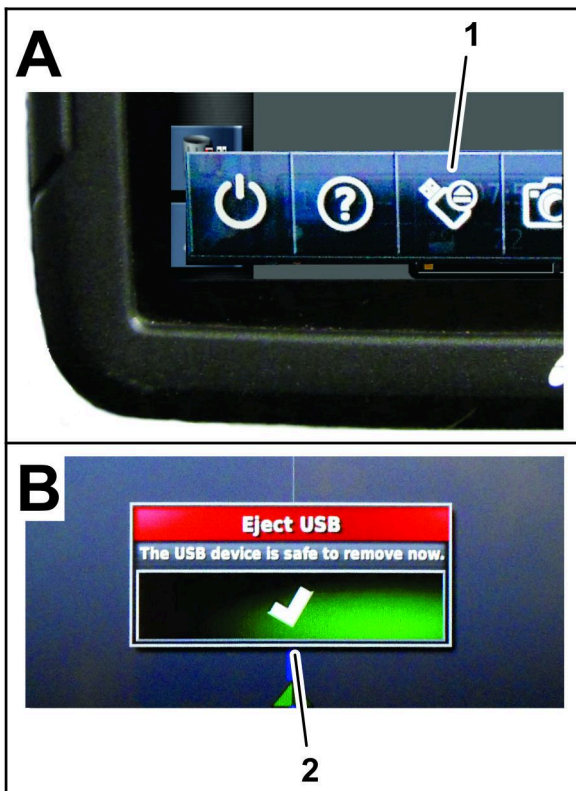

g203571

Figure 43

1. Eject USB icon
2. Confirm icon (eject USB dialog box)

-
4. Press the eject USB icon.
 5. At the eject USB dialog box, press the confirm icon and remove the USB storage device from the display.

Importing and Exporting

Open the INVENTORY MANAGER to import and export information. Press CATEGORIES to see what information can be exported.

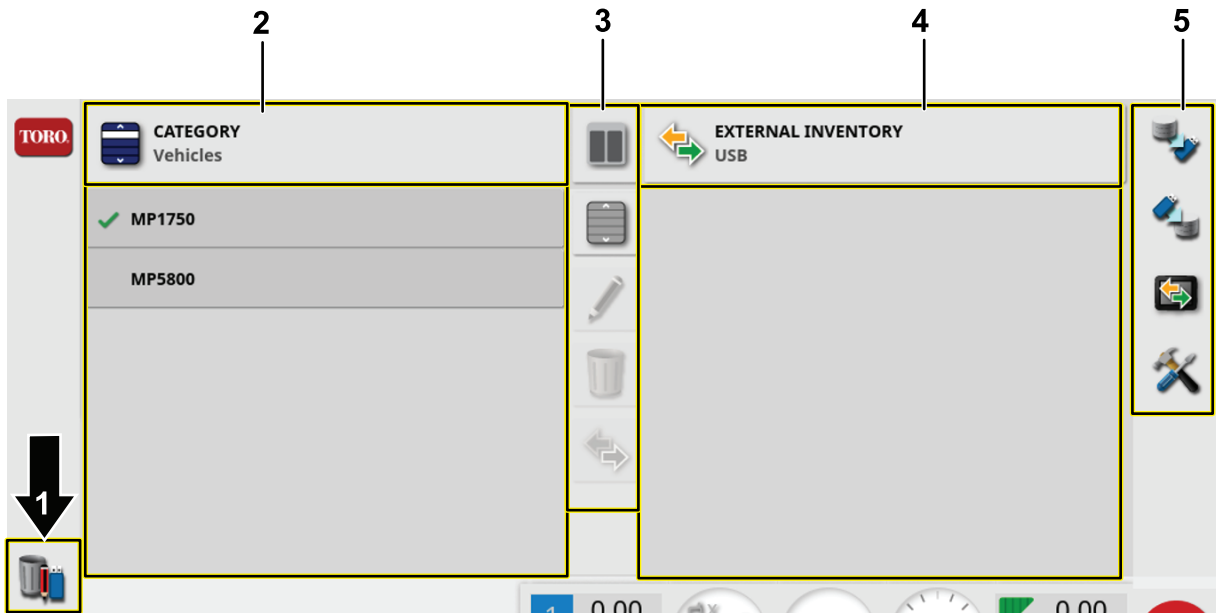

Figure 44

g431748

- | | |
|------------------------------------|----------------------|
| 1. Inventory manager icon | 4. USB data |
| 2. Display data | 5. Mass data actions |
| 3. Data modify and display options | |

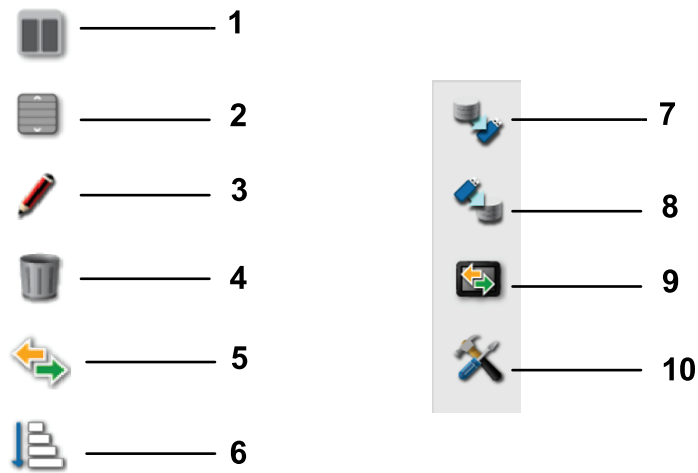

Figure 45

g431746

- | | |
|---------------|-----------|
| 1. Split view | 4. Delete |
| 2. Select all | 5. Copy |
| 3. Rename | 6. Sort |

Exporting Tasks and Task Reports

1. Select tasks from the category drop down list.
2. Select the tasks in the list on the left.
3. Select the copy icon.

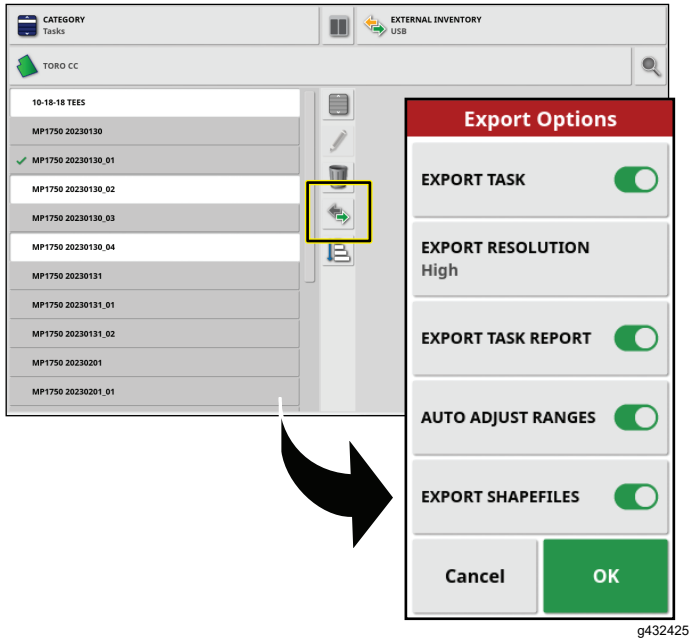

Figure 46

4. Choose which task data you want to export.

Note: Selecting export shapefiles will generate coverage, guideline group, and boundary shapefiles. These are saved in D:\Reports file under a time stamped folder.

Select Auto adjust ranges if required: If data exists that used a color legend, the colors used in the report map shading are altered so that the maximum variation in colors is used to illustrate yield rates.

Creating a Backup

This option will back up all inventory items or user settings onto a USB.

Select the BACKUP icon.

Note: Existing data on the USB will be deleted.



Figure 47

g432783

Restoring a Backup File (All inventory)

This option restores all inventory items or user settings.

This function is typically used for service.

Select the RESTORE icon.

Note: This action will overwrite any data on the control console and is used to restore content from a backup USB.



Figure 48

g432787

Exchanging Task Data

This function will copy or move all task data from the control console onto the USB.

1. Select the EXCHANGE TASK DATA icon.

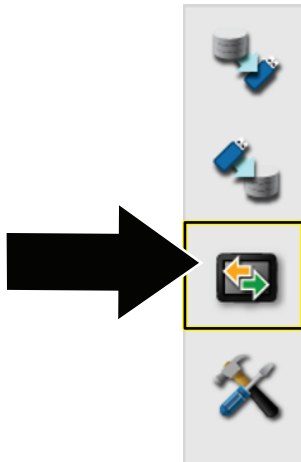

Figure 49

g432784

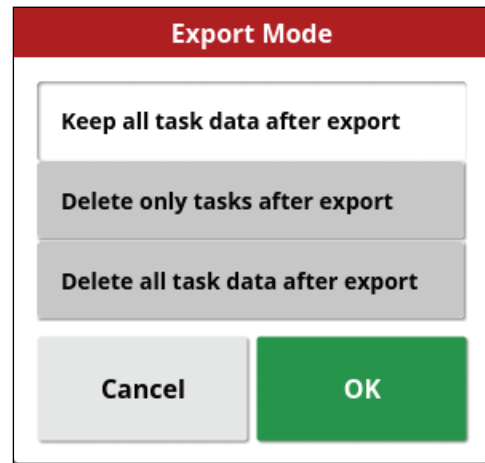

Figure 51

g432786

2. Select the export mode:

- Keep all task data after export: All of the task data is saved on the control console.
- Delete only tasks after export: All tasks are deleted from the control console but data such as fields, products, and implements is retained.
- Delete all task data after export: All of the task data is deleted from the control console.

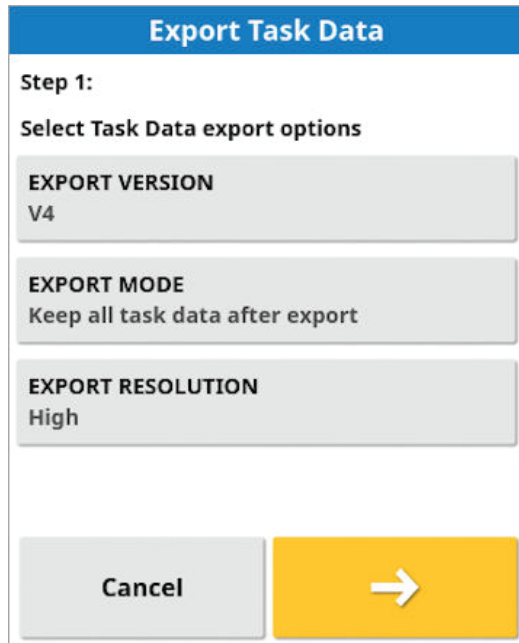

Figure 50

g432785

Managing Task Data

The task menu selects or sets up specific task information associated with the chosen area. Use this menu to store information, and record and report activity.

Understanding the Task Button

Icon	Description	Master Switch Status
	Press this icon to create and start a new task.	
	Press this icon to start a task that is selected.	
	Press to display errors that are preventing the task from running.	
	A task is currently running and the data is being recorded.	
	Press this icon to pause a task.	
	Press this icon to complete a task.	

The master switch is connected to the task button. Select or create a task to enable the master switch to start spraying.

Creating a Spray Task

Refer to [15 Creating a Spray Task \(page 17\)](#)

Selecting an Existing Task

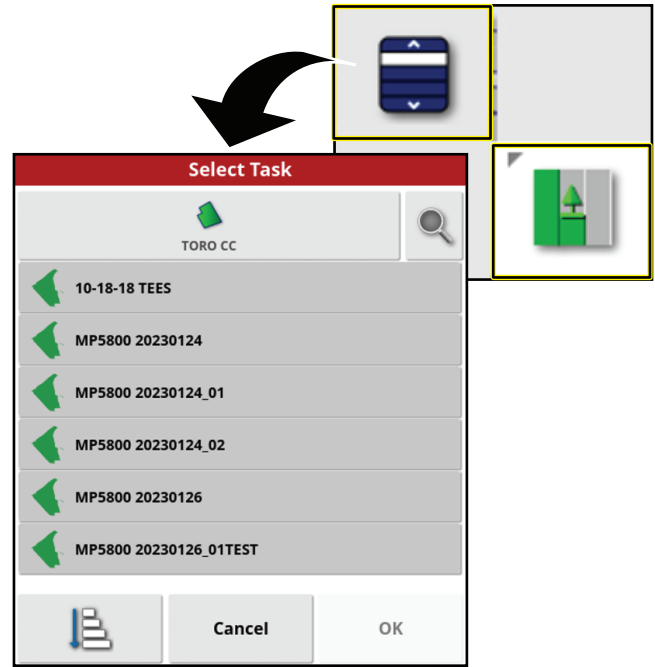

Figure 52

g432011

Configuring a New Task Region

1. Select a field, ensure that you have a boundary in the field, and the boundary is categorized.
2. Press the TASK MENU icon.
3. Press the CONFIGURE TASK REGIONS icon.

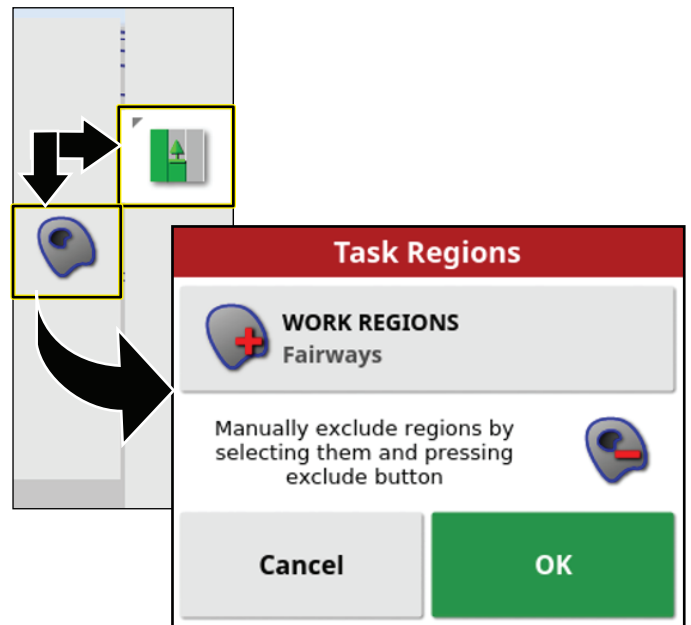

Figure 53

g431466

4. In the task region menu, select 1 of the following region types:

- Press the WORK REGIONS icon that you are spraying (i.e., fairways, greens, or tees).
- Press the EXCLUDED REGIONS icon that are not to be sprayed (bunkers, trees, hazards, etc.).

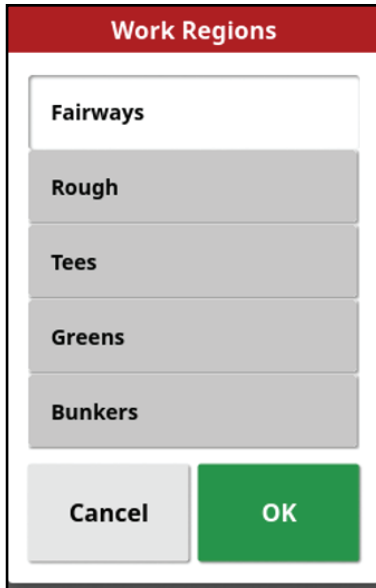

Figure 54

g431465

5. Press the confirm icon.

Recording Task Details

1. Select or create a new task.
2. Press the TASK MENU icon.

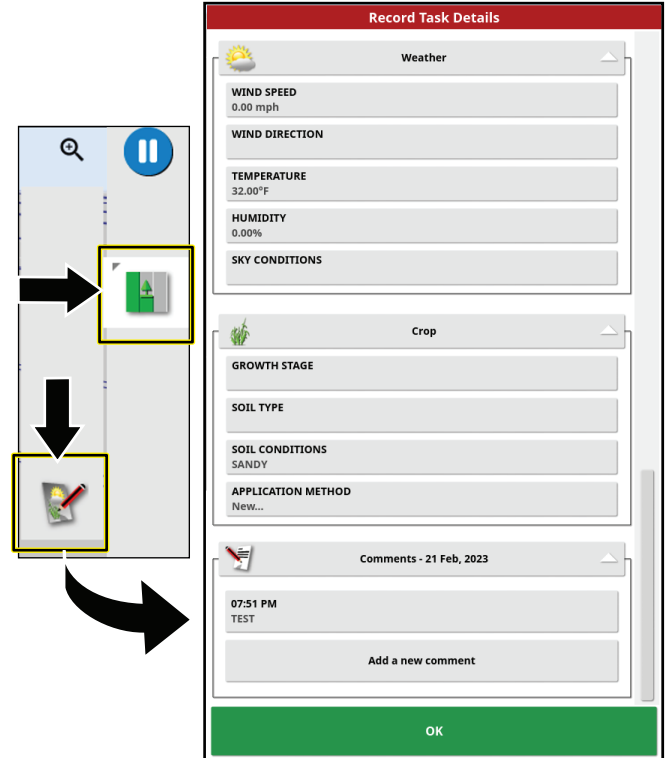

Figure 55

g431232

3. Press the task information icon.
4. Press the icons for the types of task information, enter the specific information, and press the confirm icon.

Information Types

Weather	Crop
Wind speed	Growth stage
Wind direction	Soil type
Temperature	Soil conditions
Humidity	Application method
Sky conditions	

Clearing Task Information

You can clear information for the active task, including notes and counter data; the control console keeps the record-task information.

Note: Shared task information cannot be cleared.

1. Press the TASK MENU icon.

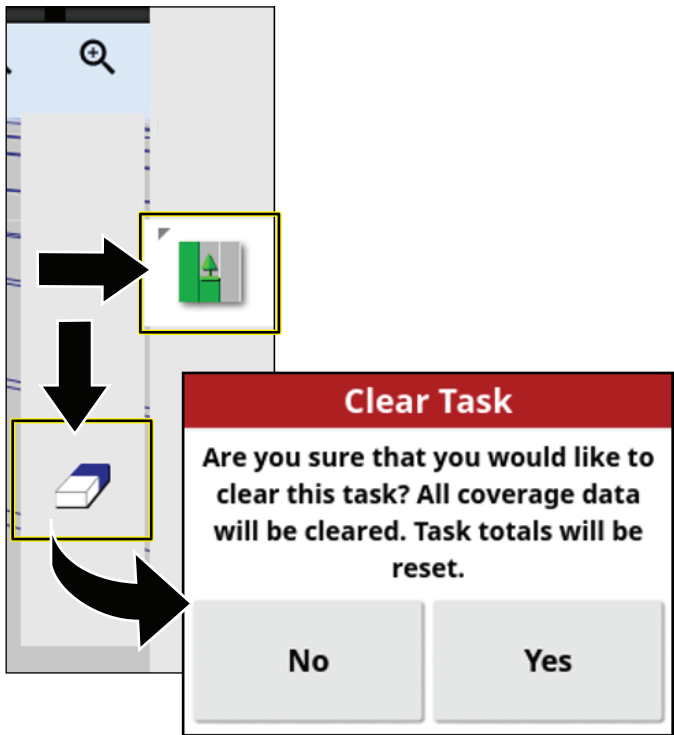

Figure 56

g430971

2. Press the CLEAR TASK DATA icon.
3. Press the Yes icon in the clear task dialog box.

Managing Field Information

Selecting a Field

1. Press the FIELD MENU icon and press the SELECT FIELD icon.

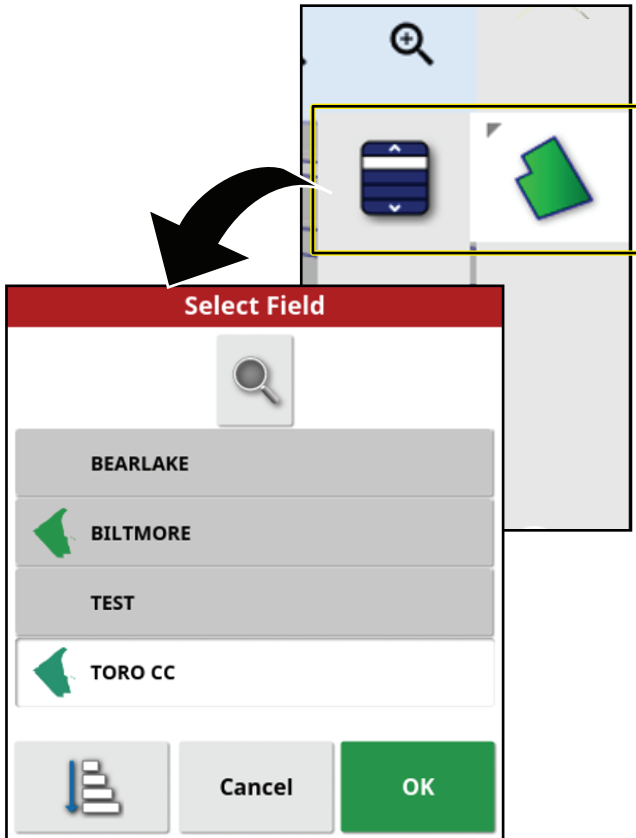

Figure 57

g430984

2. In the select field list, press the Field icon for the field you are spraying, and press the confirm icon.

Note: Unload the selected field by pressing the FIELD MENU icon and press the UNLOAD FIELD icon.

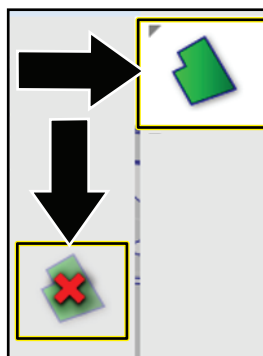

Figure 58

g432026

Recording a Field Boundary

Important: The boundaries that you create and save are accurate and repeatable only if the boundary is created while operating with a fully-fixed RTK correction.

Starting the Record Boundary

1. Drive the machine to the active field for job site.
2. Align the outside, center part of the left front tire at the starting point of the new field boundary.

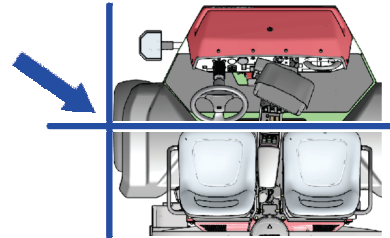

Figure 59

g294392

3. Press the FIELD MENU icon, and press the RECORD FIELD BOUNDARY icon.

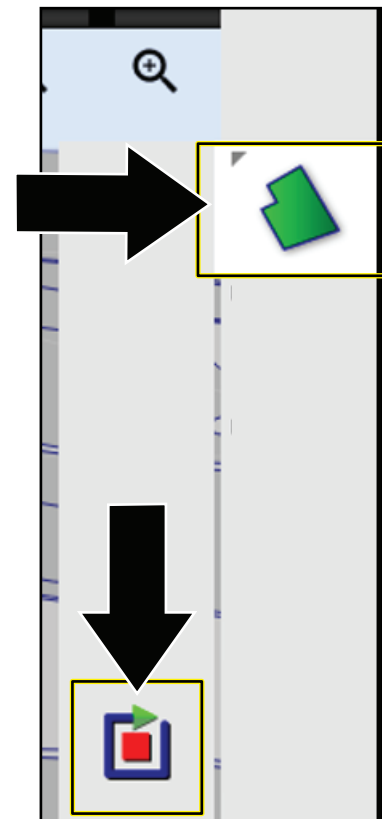

Figure 60

g430981

4. Drive the machine around the field to define the field boundary perimeter.

Note: You can drive as slow as needed and stop the machine as needed while recording the field boundary.

Pausing the Record Boundary

You can pause recording the field boundary if you need to move the machine into an area with limited space.

1. Stop the machine.
2. Press the PAUSE FIELD BOUNDARY RECORDING icon.

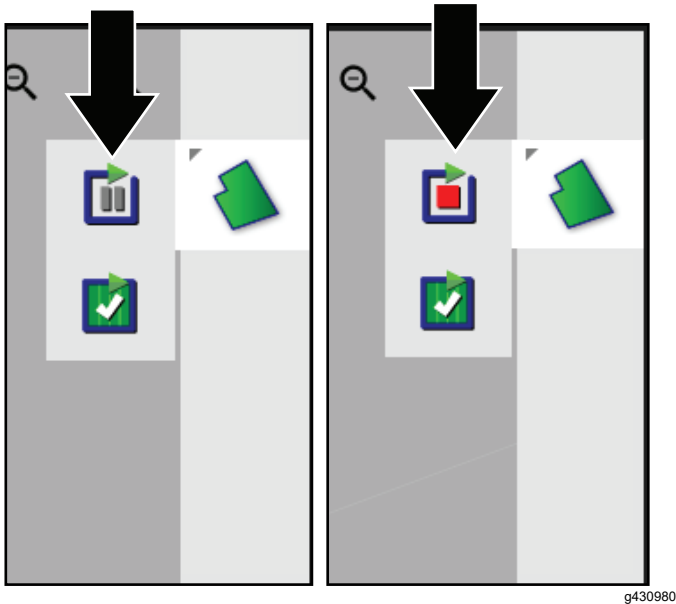

Figure 61

3. Align the machine into position.
4. Press the RECORD FIELD BOUNDARY icon to begin recording again, and continue driving the machine to define the boundary perimeter.

Note: When you resume recording the boundary, the system draws a straight line from the location where you paused recording to the location where you resumed recording the boundary.

Completing a Boundary

1. When you are close to the beginning point of the field boundary, stop the machine.
2. Press the COMPLETE FIELD BOUNDARY RECORDING icon.

Note: The control console connects the beginning and end points with a straight line.

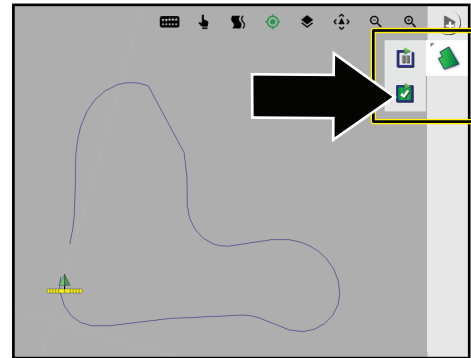

Figure 62

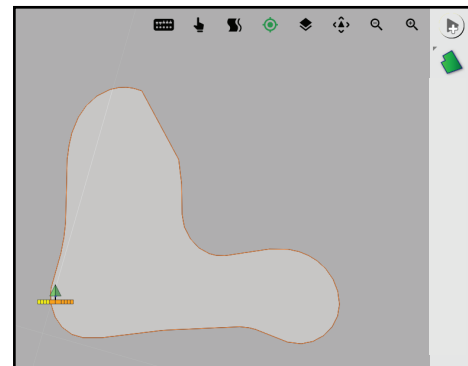

Figure 63

Creating a Boundary with All Straight Sides

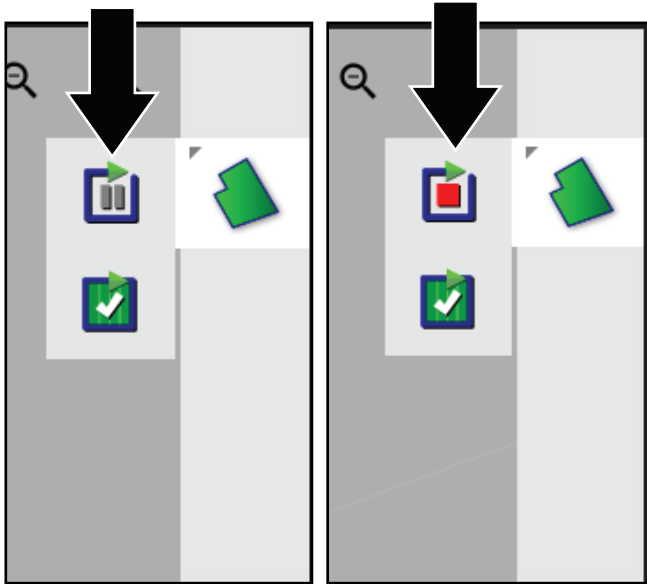

Figure 64

1. Align the outside, center part of the left front tire at the first point of the straight sided field boundary, and stop the machine.
2. Without moving the machine, press the RECORD FIELD BOUNDARY icon, and press the PAUSE FIELD BOUNDARY RECORDING icon.

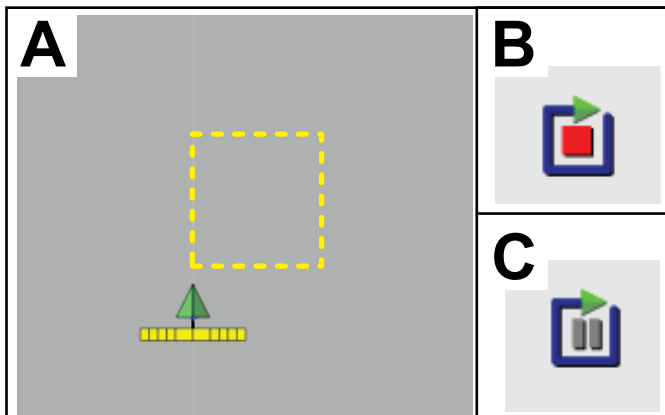

Figure 65

3. Move the machine, and align the outside, center part of the left front tire at the next point of the straight sided field boundary, and stop the machine.
4. Press the RECORD FIELD BOUNDARY icon, and press the PAUSE FIELD BOUNDARY RECORDING icon.

Note: The control console connects the 2 points with a straight line.

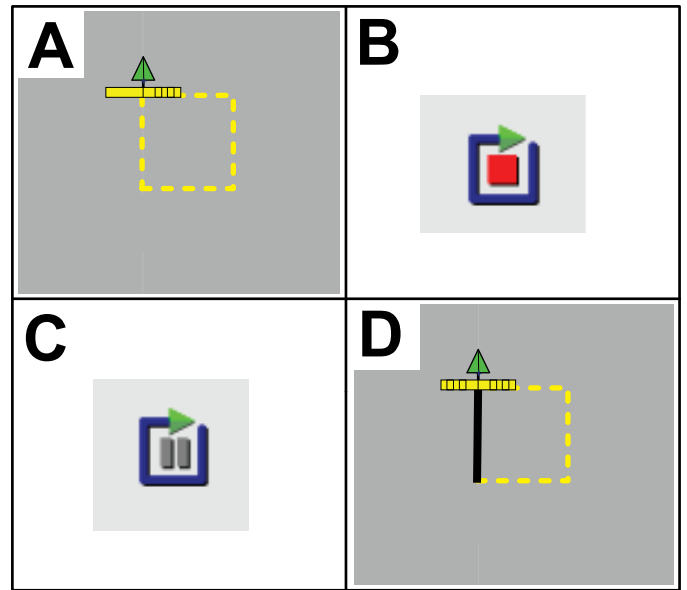

Figure 66

5. Repeat steps 3 and 4 for all the remaining points except for the last open point.
6. Align the outside, center part of the left front tire at the last point, and stop the machine.
7. Press the COMPLETE FIELD BOUNDARY RECORDING icon.

Note: The control console connects the beginning and end points with a straight line.

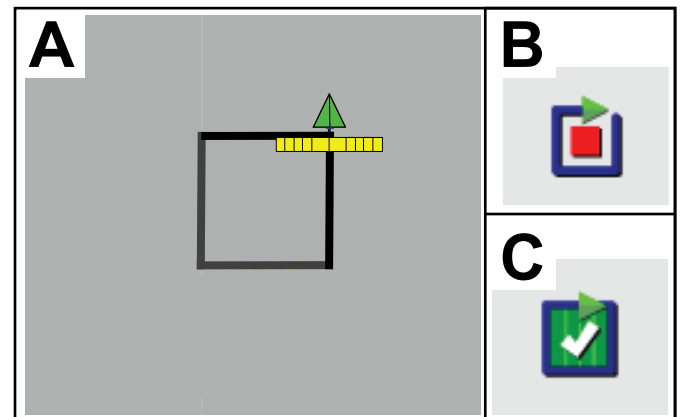

Figure 67

Creating a Boundary from Coverage

This procedure describes how to create boundaries from areas of previously recorded coverage. With only the center spray section spraying water, you can use this procedure to create exclusion boundaries for golf cart paths.

1. Park the machine near the coverage area from which you are creating a field boundary.
2. Press the Field icon and press Create Boundary from Coverage icon.

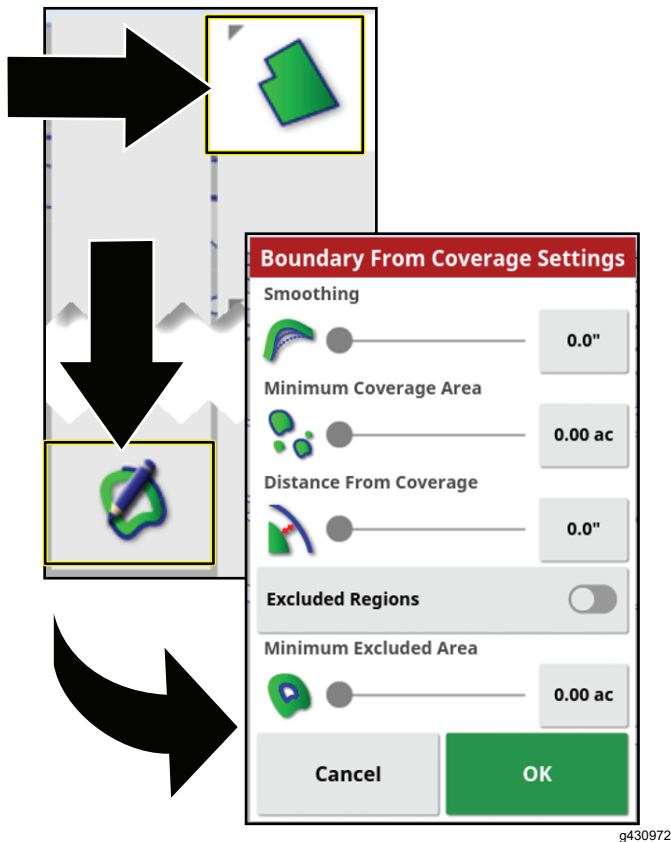

Figure 68

3. Press the number icon or sliders to update the settings.
 - The smoothing setting controls the minimum gap size that is automatically filled when creating a field boundary from coverage.
 - The minimum coverage area setting to exclude coverage smaller than the area specified (not included in the field boundary).
 - The distance from coverage setting to expand the created field boundary the specified distance away from the coverage.
 - The minimum excluded area setting is used to control exclude regions are not created from gaps smaller than the area you specify in minimum exclude area setting.

4. Press the EXCLUDED REGIONS icon to create boundaries for coverage areas that are not sprayed.

Note: Enabling exclude regions creates exclude regions from gaps within the coverage area.

Editing Field Boundary Attributes

Field boundary attributes are used to uniquely identify the boundaries within a field, and indicate to the system areas where product is applied or not applied.

- **Work Region**—work regions indicate to the system areas where product is always applied if you use auto section control. Use work regions for areas such as fine and course turf grass.
- **Excluded Region**—excluded regions indicate to the system areas where product is never applied if you use auto section control. Use excluded regions for areas such as water features, sand features, and walking or cart paths.
- **Categorized Region**
 - Categorized regions are used for fields with many boundaries.
 - Assigning each boundary to a category is useful when including boundaries when applying a product or excluding a boundary when applying another product.
 - You can use categorized regions to define work regions and excluded regions for the current task.
 - In addition to the preset categorized regions, you can create new categorized application regions for unique boundary-product application or unique boundary-product exclusion.

After creating the boundary, press your finger on the control console screen next to the boundary line until the boundary-selection icon illuminates, and slid your finger to the boundary line. Remove your finger from the screen, and the edit boundary dialog box opens.

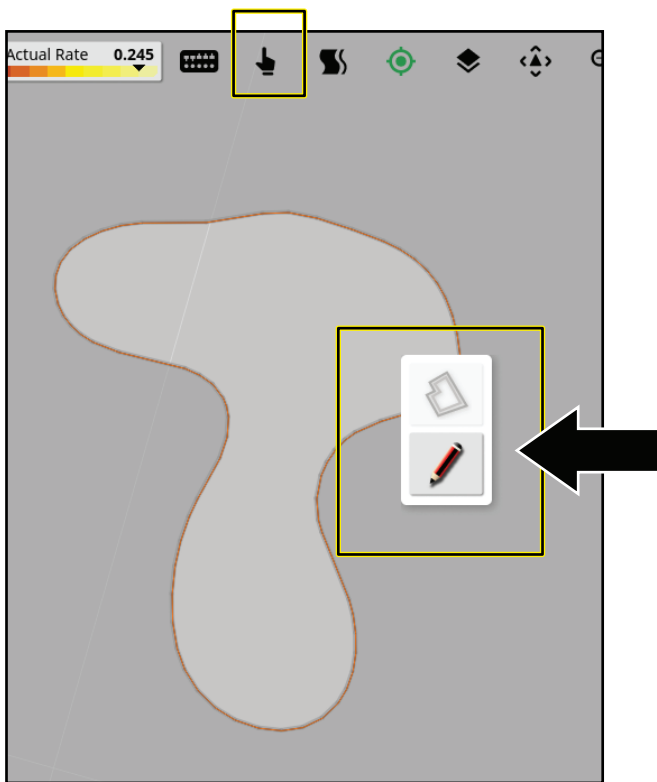

Figure 69

g430976

Naming a Field Boundary

Press the name icon, use the on-screen keyboard to type in the boundary name, and press the confirm icon.

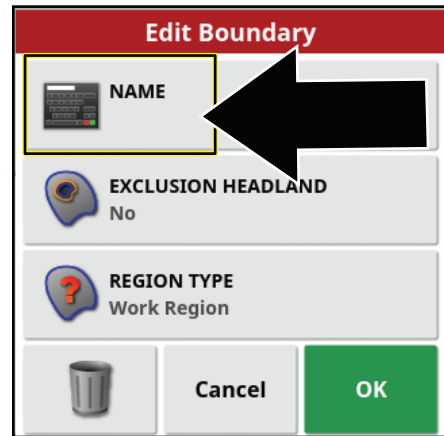

Figure 71

g435477

Setting a Work Region Field Boundary

1. In the edit boundary dialog box, press the REGION TYPE icon.

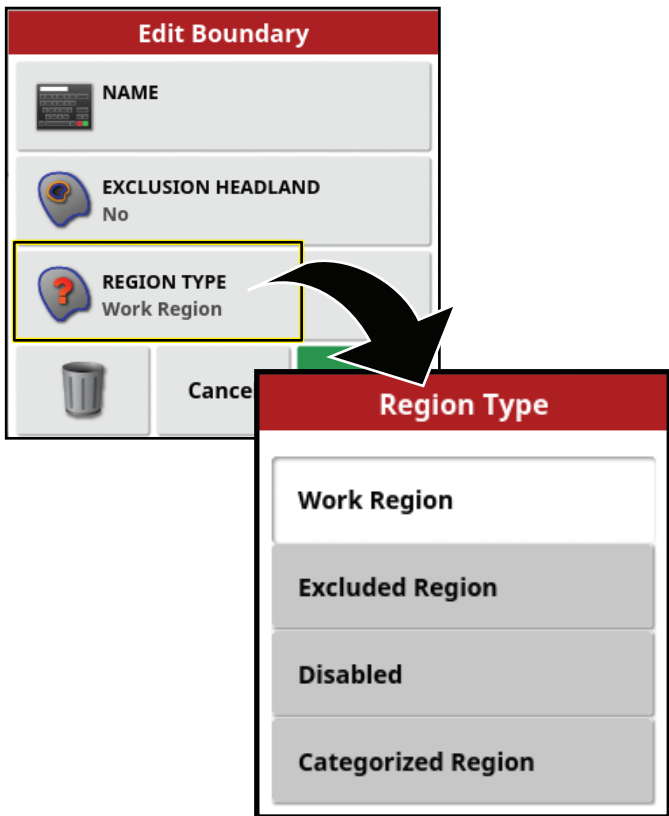

Figure 70

g435478

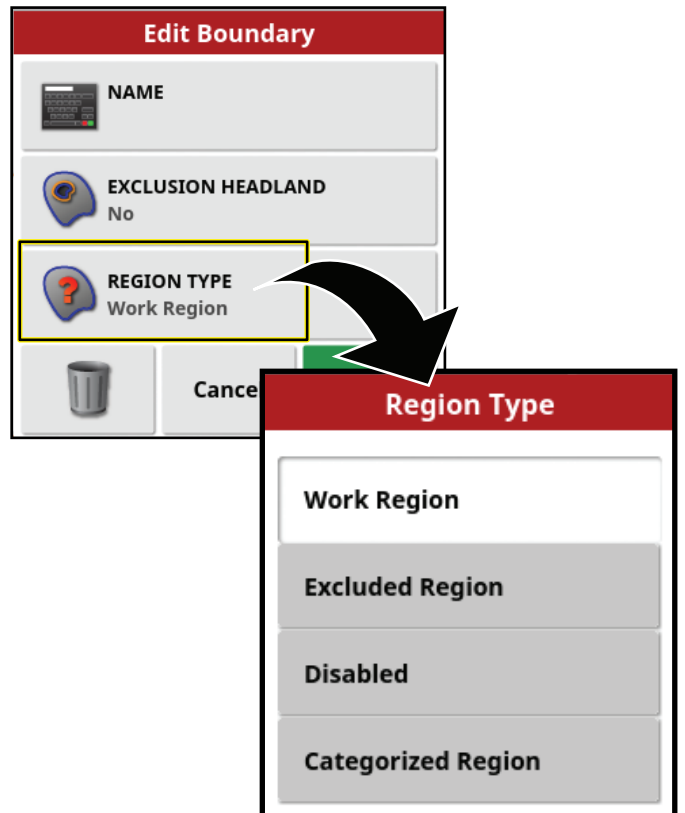

Figure 72

g435478

2. In the regions type dialog box, press the WORK REGION icon.

3. Select the work regions type and press the confirm icon.

Setting an Excluded Region Field Boundary

Note: Setting an excluded region field boundary permanently excludes spraying the area in the boundary of the field. An excluded region field boundary is different from configuring in the spray task with an excluded region.

1. In the edit boundary dialog box, press the REGION TYPE icon.

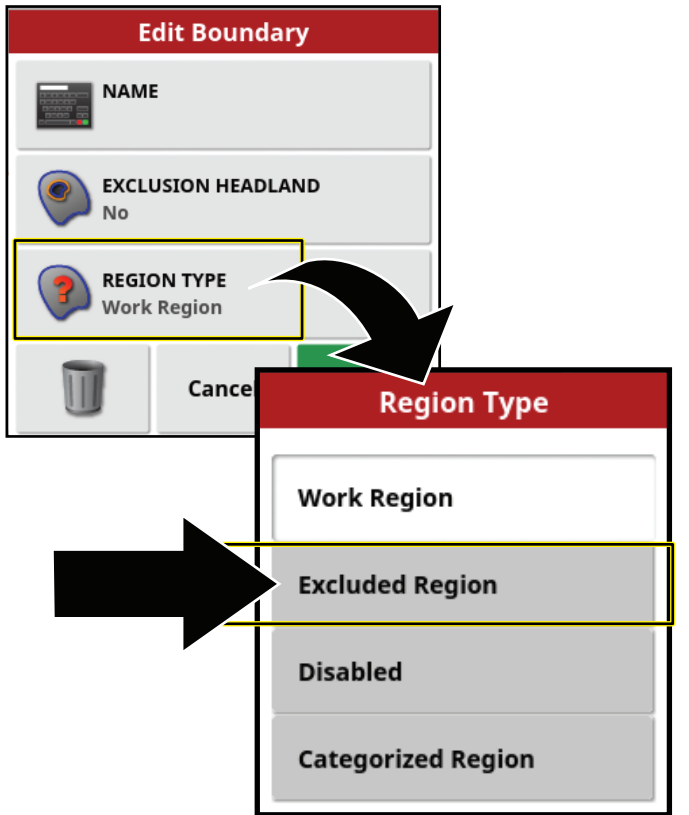

Figure 73

g435480

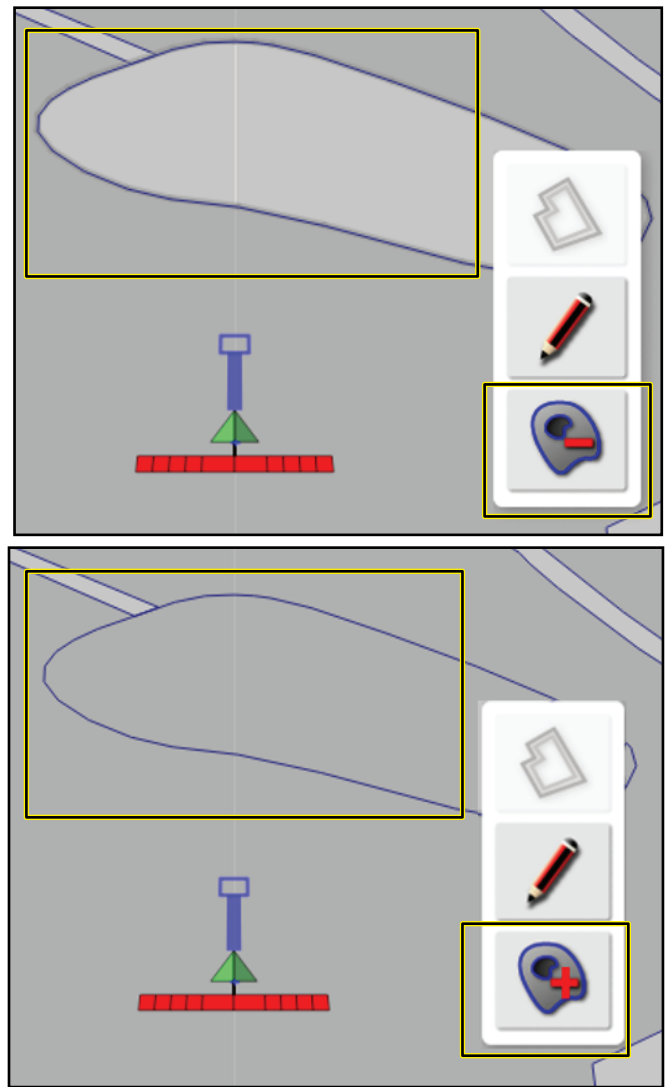

Figure 74

g430291

2. Select the region to exclude and select the region icon with the minus sign.

Note: Select the region icon with the plus sign to include the region again.

Setting a Categorized Field Boundary

1. In the edit boundary dialog box, press the REGION TYPE icon.

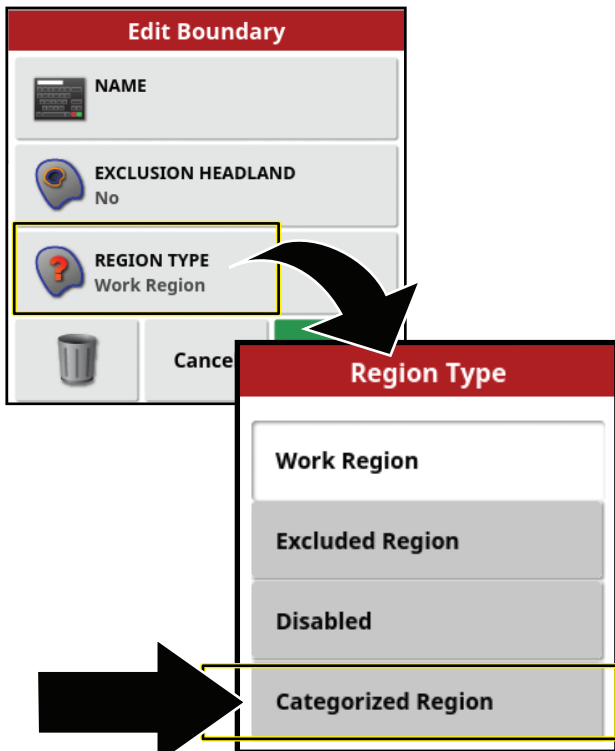

Figure 75

2. In the regions type dialog box, press the CATEGORIZED REGION icon, and press the Confirm icon.
3. In the edit boundary dialog box, press the CATEGORY icon to display a list of category types.
4. In the category types list, press the icon for a preset category types, or select the NEW . . . icon.

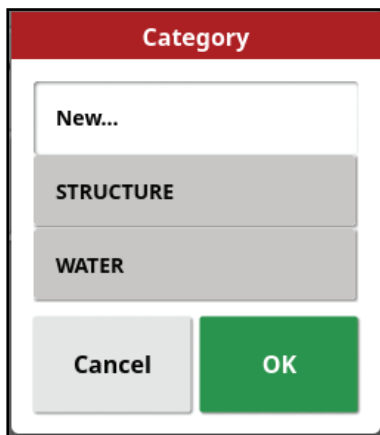

Figure 76

5. The selected category type displays, and press the confirm icon.

Flag Points

You add flag points to the control console map while you are creating field boundaries or spraying to identify terrain features or hazards for the site.

Setting a Flag Point

1. Drive the machine to the location of the terrain feature that you want to mark with a flag point, and stop the machine.
2. Press FIELD MENU icon and the SET FLAG POINT icon.

The add flag point menu displays.

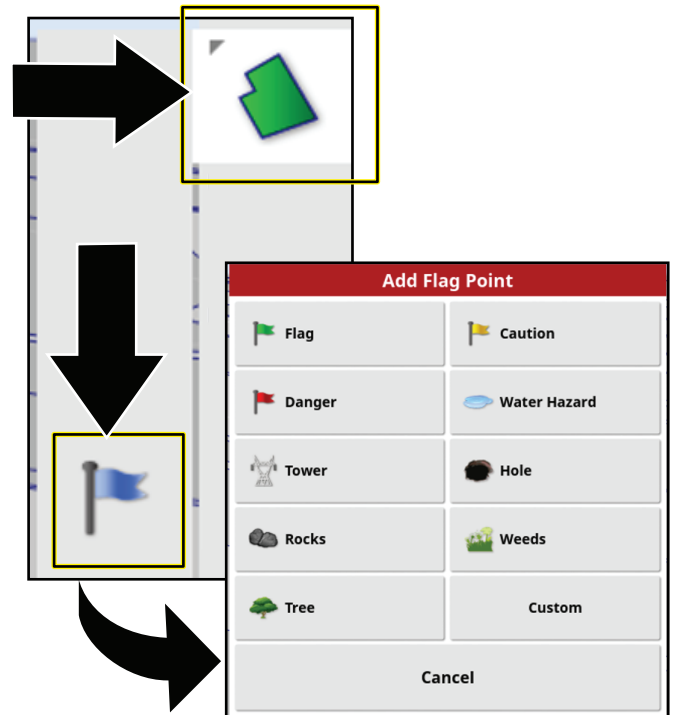

Figure 77

3. In the add flag point menu, select a flag point icon.

The flag point displays in the control console behind the vehicle.

Note: The flag point drop location is beneath the machine, at the centerline, and between the rear tires.

Setting a Custom Flag Point

1. Drive the machine to the location of the terrain feature that you want to mark with a flag point, and stop the machine.
2. In the add flag point menu, press FIELD MENU icon and the SET FLAG POINT icon.
3. Press the CUSTOM flag point icon.

The add flag point dialog box displays.

4. In the add flag point dialog box, press a flag point icon, and press the FLAG POINT NAME icon.

The on-screen keyboard displays.

5. Use the on-screen keyboard to type the name of the custom flag point, and press the confirm icon.
6. In the add flag point dialog box, press the confirm icon.

The flag point displays in the control console behind the vehicle.

Editing Flag Points

1. Press your finger on flag point in command console screen until the flag point pop-up displays.

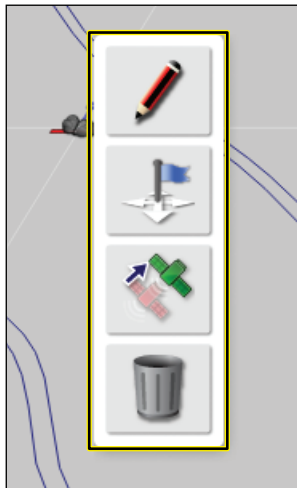

Figure 78

g431481

2. Remove your finger from the screen.
The flag edit menu displays.

Changing a Flag Point Type

1. In the edit flag menu, press the CHANGE icon.

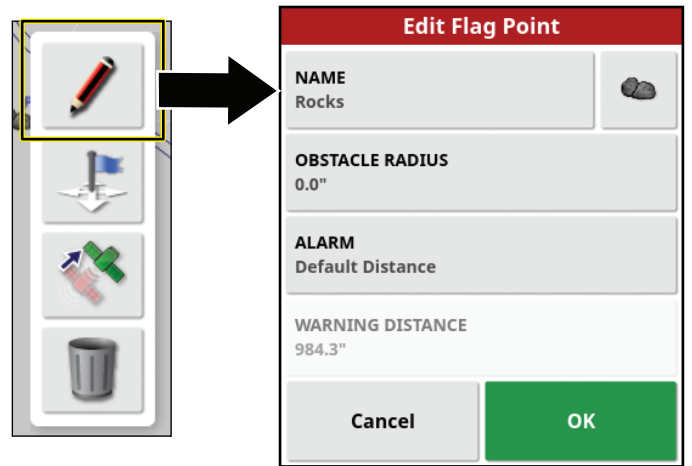

g431480

Figure 79

2. In the change flag point menu, change the name, icon, obstacle radius, or the alarm distance.

Moving a Flag Point

1. In the edit flag menu, press the MOVE icon.

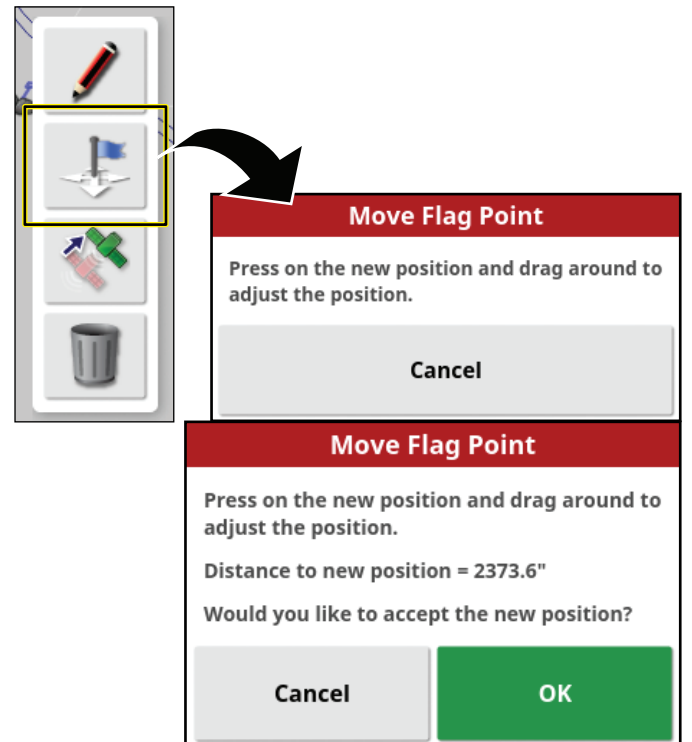

g431479

Figure 80

2. Drag the flag icon to a new location and press the confirmation icon.

Deleting a Flag Point

1. In the edit flag menu, press the DELETE icon.

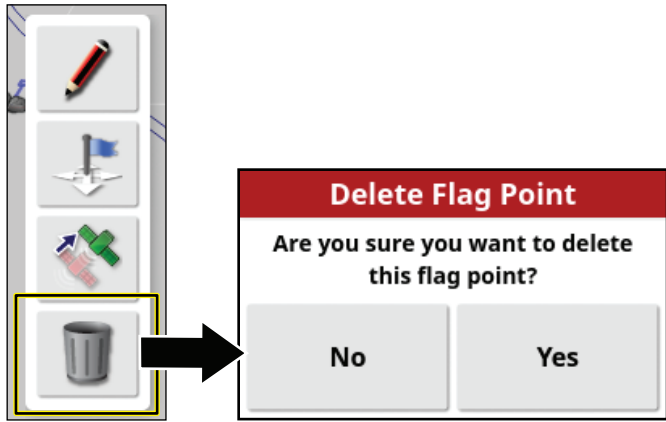

Figure 81

g431477

2. In the delete flag point dialog box, press the YES icon.

Setting the Tank Volume

1. Press the SPRAYER MENU icon.

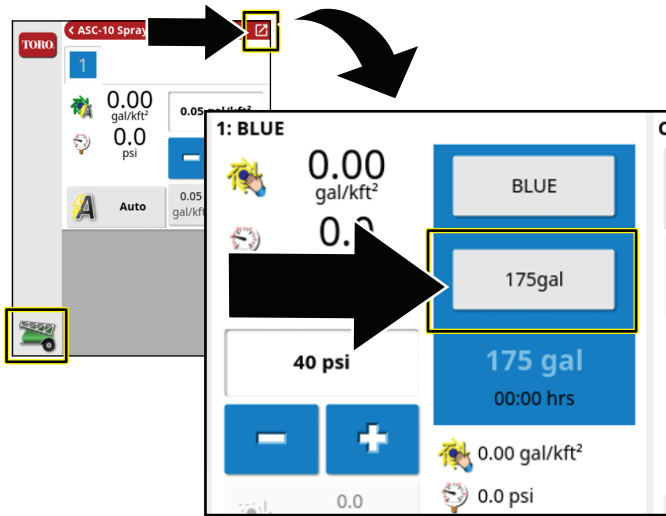

Figure 82

g431473

2. Press the VOLUME icon.
3. Use the numeric pad of the display to enter 1 of the following:

Note: Press the INCREMENT VALUE or DECREMENT VALUE icons to enter a preset increment of product volume quantity.

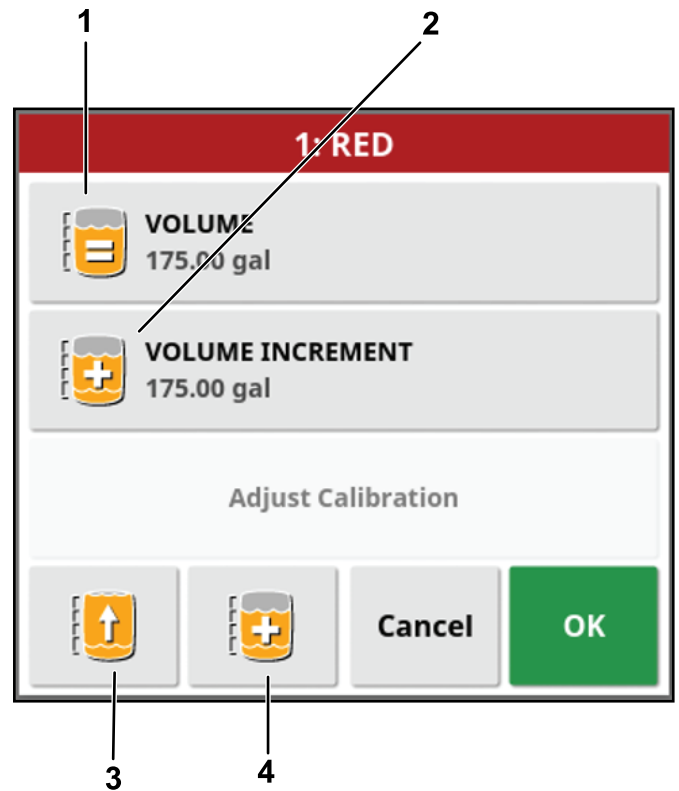

Figure 83

g430988

1. Set the volume of the product in the tank.
2. Set the volume to be used when increasing the product volume incrementally.
3. Fill the tank to full capacity.
4. Fill the tank with the increment value.

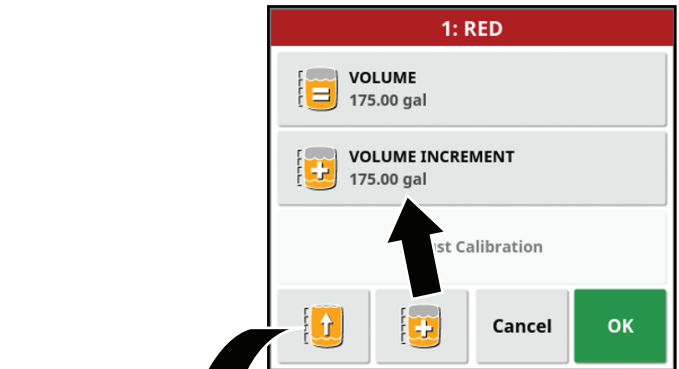

Figure 84

g432793

- If you are entering a final product volume into the tank (such as water and chemicals), enter the total volume of product that you will add product to the tank, press the confirm icon, and press the confirm icon on the tank fill window.

Note: The volume of water and product is less than or equal to the configured tank capacity.

- If you are incrementally adding chemicals to water, enter the volume of water in the tank, press the confirm icon, and proceed to step 4.

Note: The volume of water and product is less than or equal to the configured tank capacity.

4. If you are incrementally adding chemicals to water, press the VOLUME INCREMENTS icon.
5. Use the numeric pad of the display to enter increment of the volume of product (such as chemicals to water) that you will add product to the tank, and press the confirm icon.

Example: 19 L (5 gallon), 114 L (30 gallon), or 208 L (55 gallon) increments.

6. If you are incrementally adding chemicals to water, add the product into the tank and press the INCREMENT AMOUNT OF PRODUCT icon.
7. If you are filling the tank to capacity with a product or water, you can press the FILL TANK TO CAPACITY icon.
8. Press the confirm icon and press the confirm icon on the tank fill window.

ASC Boom Control

Setting the Control Mode

Note: This setting controls the amount of nozzle-spray overlap for adjacent sprayer passes at the outermost spray nozzles (as a percentage of the spray pattern).

The default setting is 50.

1. Press the AUTO SECTION CONTROL icon.

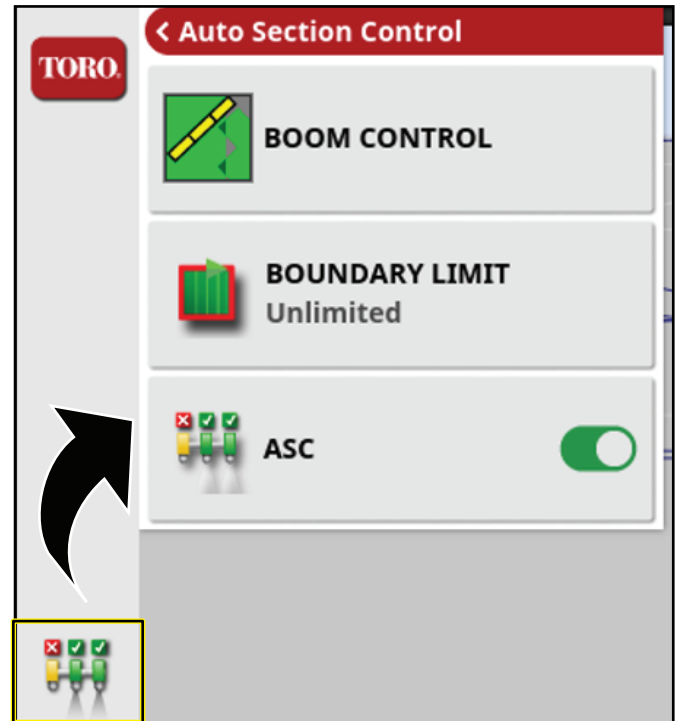

Figure 85

2. Press the BOOM CONTROL icon.
 - Set the percentage in CONTROL MODE to avoid overlapping (0) or to avoid gaps (100).
 - Avoiding overlapping could cause spaces where the product is not applied.
 - Avoiding gaps could cause some overlap of application.
 - Set the distance in OVERLAP ENTERING COVERED AREA to set the amount of overlap to occur when entering a completed area.
 - Set the distance in OVERLAP EXITING COVERED AREA to set the amount of overlap to occur when exiting a completed area.

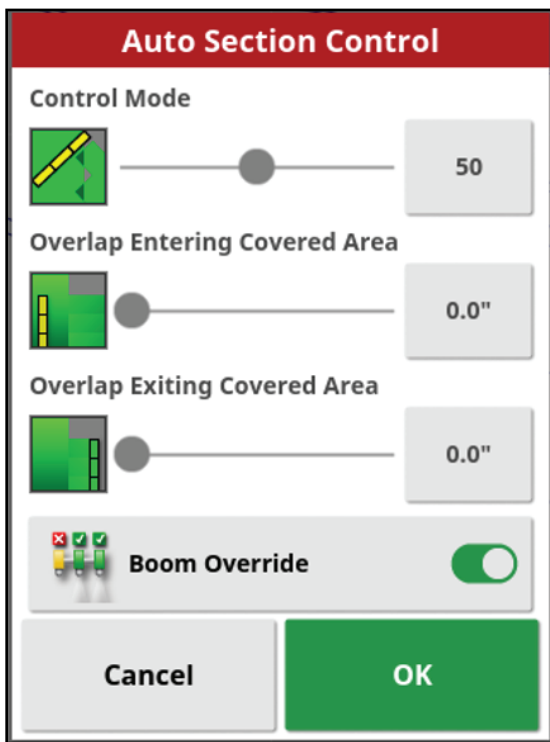

Figure 86

g430967

3. Set the Boundary Limit.

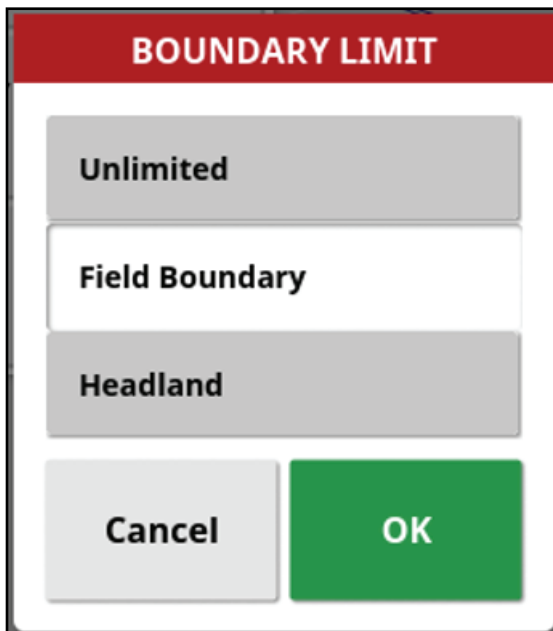

Figure 87

g430968

Choosing a Spraying Method

Spray Methods

	Auto Section Control	Boundary Limit	Rate Control	Description
Field Boundary	On	Field Boundary	Auto	<ul style="list-style-type: none"> The GeoLink system controls the nozzle sections within a field boundary and with pass-to-pass control. The GeoLink system controls the application rate.
Unlimited	On	Unlimited	Auto	<ul style="list-style-type: none"> The GeoLink system controls the nozzle sections with pass to pass control without any field boundary. The GeoLink system controls the application rate.
Manual Section Control	Off	Field Boundary	Auto	<ul style="list-style-type: none"> The operator controls the boom sections. The GeoLink system controls the application rate.
Full Manual Control	Off	Field Boundary	Manual	<ul style="list-style-type: none"> The operator controls the spray sections. The operator controls the application rate.

Automatic Section Control

Automatic Section Control (ASC) Icon Description

Setting	Description
ASC ON	The machine controls the operation of the individual nozzle sections.
ASC OFF	The operator controls the nozzle sections as groups with the left, center, and right spray-section switches.

Boundary Limit

Boundary Limit Icon Description

Setting	Description
FIELD BOUNDARY	The machine turns on nozzle sections as the turf sprayer enters the field boundary of a work region.
	The machine turns off nozzle sections as the turf sprayer enters excluded regions within the work region.
	The machine turns off nozzle sections as the turf sprayer exits the field boundary of a work region.
	The machine turns off nozzle sections where pass-to-pass spraying overlaps.
UNLIMITED	The machine controls the nozzle sections with pass to pass control, but without any field boundary.
	The machine turns off nozzle sections where pass-to-pass spraying overlaps.

Rate Control

Rate Control Icon Description

Setting	Description
Automatic (Auto)	The machine controls the application rate based on the rate that you set for the active spray task or the rate you set in the sprayer control panel.
Manual	The operator controls the application rate while spraying.
Pressure	The machine operates to the pressure that you set for the active spray task.

Configuring the Machine for Each Spray Method

Field Boundary Spraying Method

	Auto Section Control	Boundary Limit	Rate Control	Description
Field Boundary	On	Field Boundary	Auto	<ul style="list-style-type: none"> The GeoLink system controls the nozzle sections within a field boundary and with pass-to-pass control. The GeoLink system controls the application rate.

Auto Section Control

BOOM CONTROL

BOUNDARY LIMIT
Field Boundary

ASC

ASC-10 Sprayer

1

0.00 gal/kft² 0.05 gal/kft²

0.0 psi

A Auto 0.05 gal/kft² 0.10 gal/kft²

Unlimited Spraying Method

	Auto Section Control	Boundary Limit	Rate Control	Description
Unlimited	On	Unlimited	Auto	<ul style="list-style-type: none"> The GeoLink system controls the nozzle sections with pass to pass control without any field boundary. The GeoLink system controls the application rate.

Manual Section Control Spray Method

	Auto Section Control	Boundary Limit	Rate Control	Description
Manual Section Control	Off	Field Boundary	Auto	<ul style="list-style-type: none"> The operator controls the boom sections. The GeoLink system controls the application rate.

Full Manual Spray Method

	Auto Section Control	Boundary Limit	Rate Control	Description
Full Manual Control	Off	Field Boundary	Manual	<ul style="list-style-type: none"> The operator controls the spray sections. The operator controls the application rate.

Configuring the Sprayer Controls for a New Task

Creating a Spray Nozzle

Note: The standard ISO list is already loaded in the display.

1. Click on NEW NOZZLE... or COPY SELECTED NOZZLE from the IMPLEMENT setup screen.

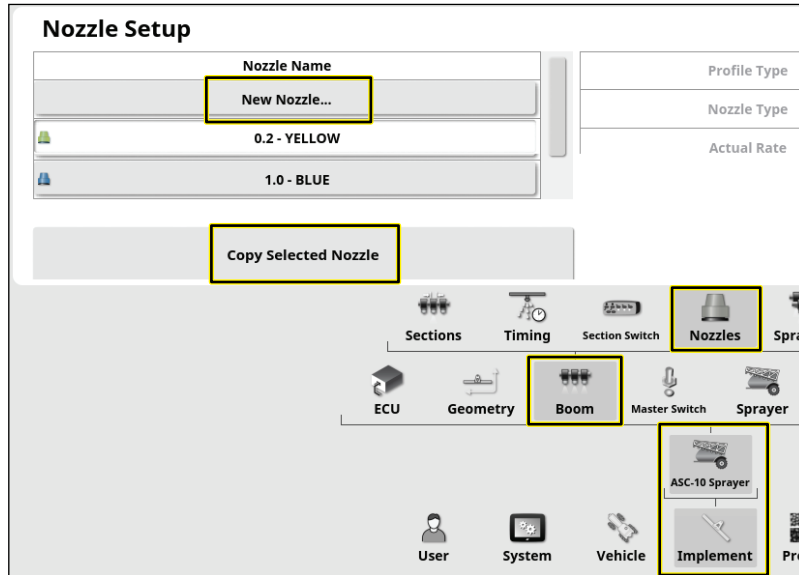

Figure 88

g432797

2. Go through the create nozzle setup wizard.

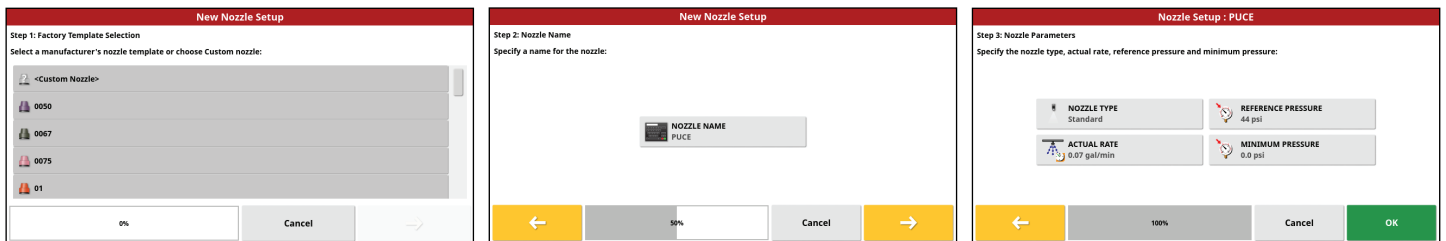

Figure 89

g432798

3. Your new nozzle will now appear in the task nozzle menu.

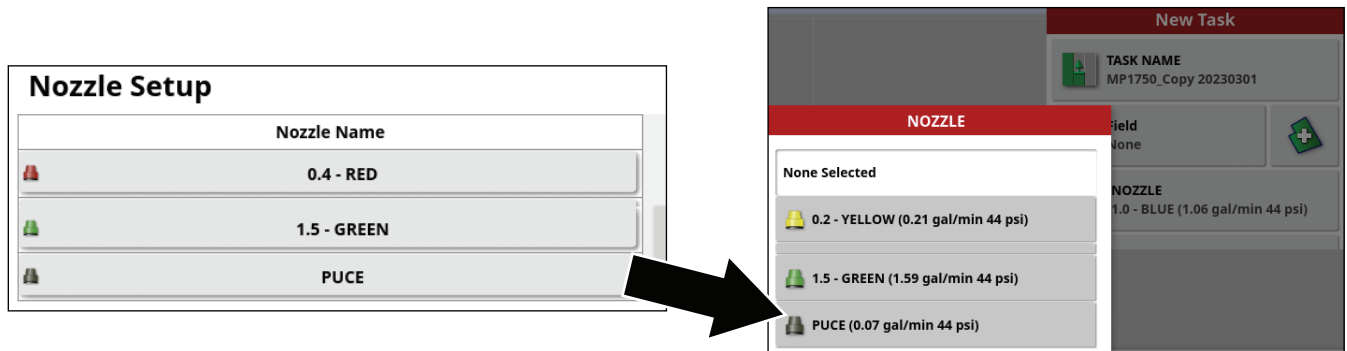

Figure 90

g432796

Selecting the Spray Nozzle—Balancing the Nozzle Valves

Multi Pro 1750 Turf Sprayer

Important: When you create a task, the nozzle size to which the GeoLink system is controlled shows on the display. You must use the valve balance wizard each time you change spray nozzles.

1. Fill the sprayer tank with clean water.
2. Ensure that the parking brake is engaged, and the gear selector is in the NEUTRAL position.
3. Start the engine, lower the boom sections, set the machine master-section switch to the OFF position, and set the 3 section switches to the ON positions.
4. Ensure that the agitation bypass valve is balanced, and that the spray system pressure is more than 207 kPa (30 psi); refer to your *Operator's Manual*.
5. Press the spray rate controller icon, and then swipe the full screen icon in the upper right corner of the sprayer controller window.



Figure 91

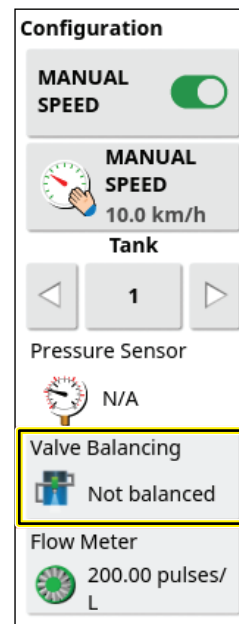

Figure 92

g432838

7. Go through the wizard.
 - A. Select the nozzle.

Note: If the nozzle for the application rate that you are spraying does not appear in the list, you will need to create a nozzle before using the valve balancing wizard.
 - B. Set the pressure rate to 2.75 bar (40 psi).
 - C. Bring the throttle to 1/2 to 3/4 full throttle and set the throttle lock.
 - D. On the machine, set the master-section to the ON position.
 - E. Wait for the system flow rate to stabilize and the lock icon to appear in the dialog box.
 - F. Press the section On/Off icon to shut off the section valve (red). Press the next icon.

6. Press the configuration icon, and then press the valve balance wizard icon.

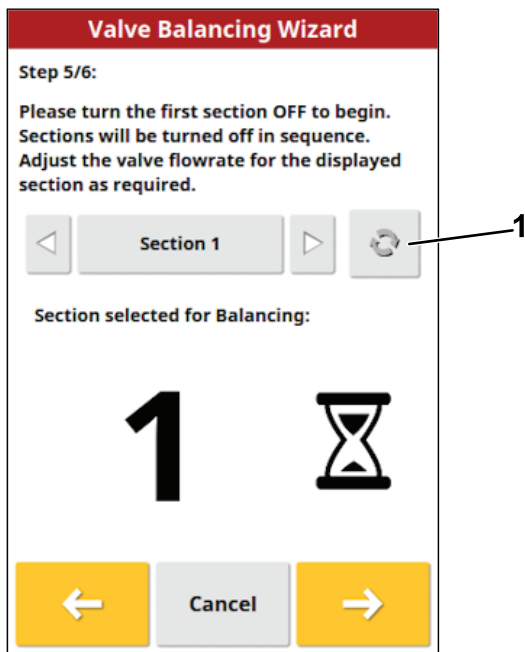

Figure 93

g432836

1. Section On/Off icon

G. Adjust the pressure as needed.

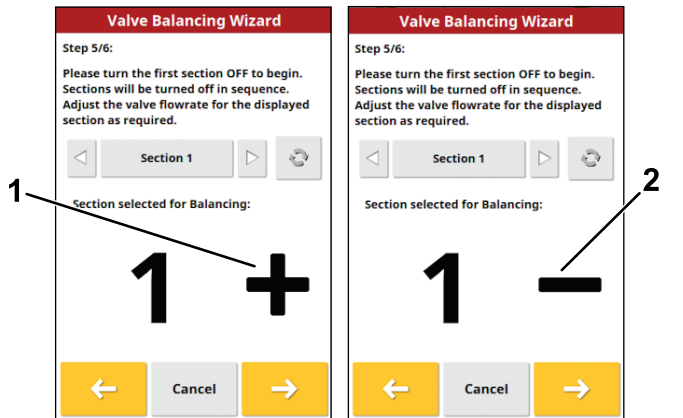

Figure 94

g432837

1. The pressure is too low. Turn the bypass valve to increase the pressure.
2. The pressure is too high. Turn the bypass valve to decrease the pressure.

H. Once the section is balanced, an information screen is displayed and the next section will turn off.

1. Ensure that all the bypass valves are adjusted and press the confirm icon.

Note: If the nozzle valves will not balance, lower the engine speed and go through the wizard again.

Nozzle Table

Nozzle	Nozzle Color	Flow Rate
0.2	Yellow	0.8 lpm (0.2 gpm)
0.4	Red	1.5 lpm (0.4 gpm)
0.5	Brown	1.9 lpm (0.5 gpm)
0.6	Gray	2.3 lpm (0.6 gpm)
0.8	White	3.0 lpm (0.8 gpm)
1.0	Blue	3.8 lpm (1.0 gpm)
1.5	Green	5.7 lpm (1.5 gpm)

Selecting the Spray Nozzle

Multi Pro 5800 Turf Sprayer

1. In the new task menu, press the nozzle icon.

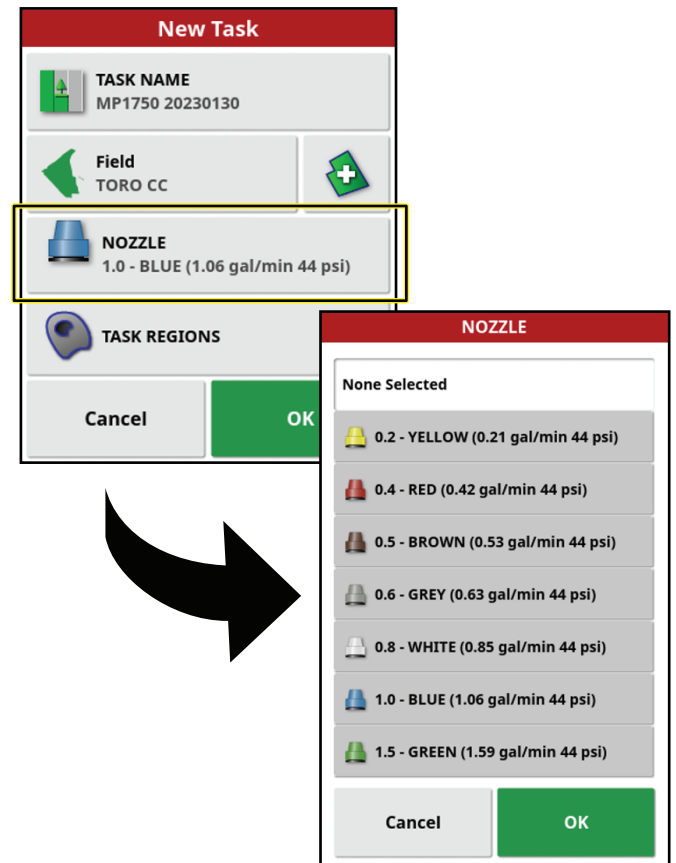

Figure 95

g430986

2. In the drop-down list, select the nozzle for the application rate that you are spraying.

Note: If the nozzle for the application rate that you are spraying does not appear in the list, you will need to create a new nozzle before using the valve balancing wizard.

3. Press the confirm icon.

MachineLink

Converting Legacy Data (M2M-Retro Kit Only)

Use this process to bring over data from your 4.xx software and convert it to 5.xx software.

Important: Ensure that you have installed the high gain antenna (sold separately); refer to the *GeoLink Finishing Kit* for your model.

1. Navigate to the UTILITIES screen and select CONTROL SOFTWARE UPGRADE.

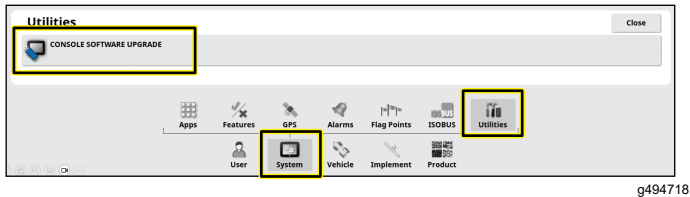

Figure 96

2. Insert the MachineLink USB into the back of the display.
3. Navigate to the LICENSES screen and select IMPORT LICENSE DATA.

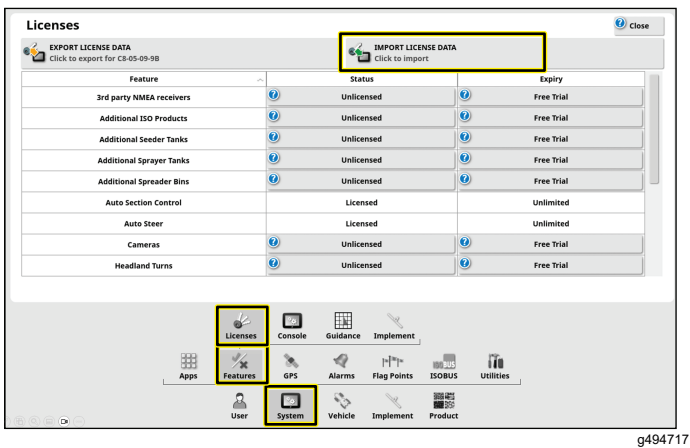

Figure 97

4. Enable MachineLink.

Enabling MachineLink

MachineLink enables coverage to be shared between multiple implements operating in the same field.

Note: Ensure that you have the high-gain antenna (sold separately) connected to the modem; refer to the *GeoLink Finishing Kit*.

1. In SETUP, go to SYSTEM, FEATURES, then IMPLEMENT.
2. Change MACHINELINK to enabled.

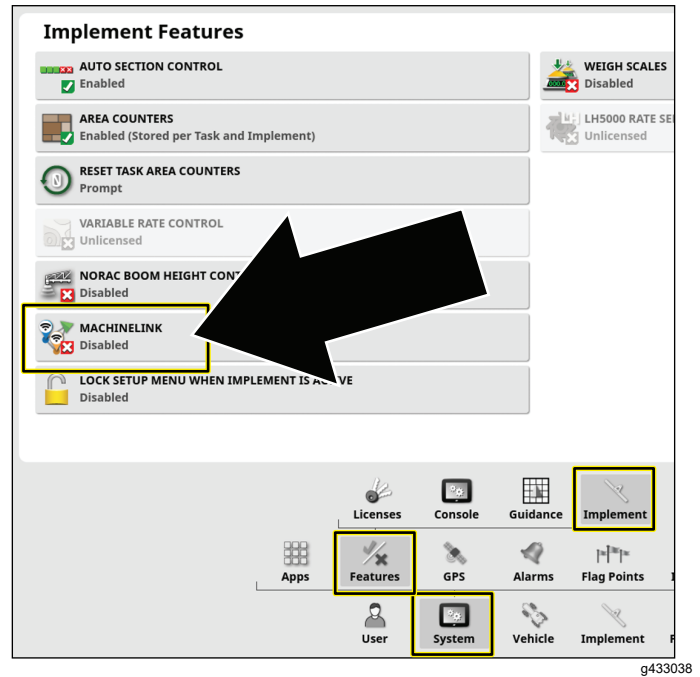

Figure 98

3. Ensure that SHARED COVERAGE is highlighted in the MAP LAYERS MENU.
 - Shared coverage will show the coverage of MachineLink machines in the same field.
 - Remote machines will show vehicles on the map that are connected to the network.

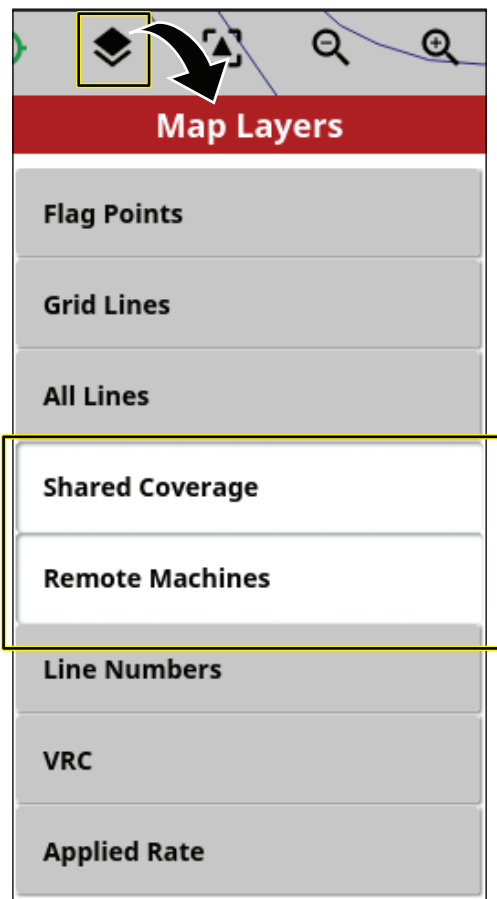

Figure 99

g433042

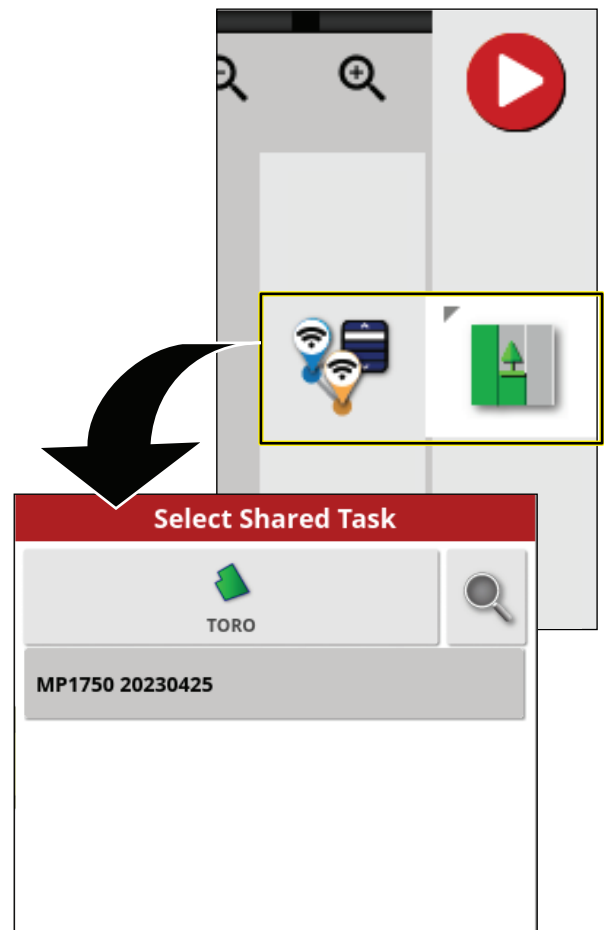

Figure 101

g442408

Joining a Shared Task

MachineLink enabled machines nearby are notified that a new shared task is available; refer to [MachineLink \(page 50\)](#)

1. Select OK or select the JOIN TASK option in the TASK MENU.

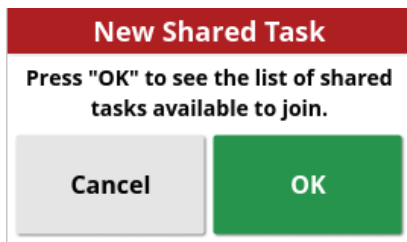

Figure 100

g442407

2. Select a task to join.

Note: The product being applied remotely must match the products in the local implement.

The system will match the products being used remotely to the products on the local machine by:

- Matching the products that have been previously linked.
- Matching the name of the products.
- Matching the previous assignment or name of the products.

The below screen will display if the products do not match.

- Task product will display the product being applied remotely.
- Local product will display the product being applied locally.
- Tank(s) will list the tank containing the product.

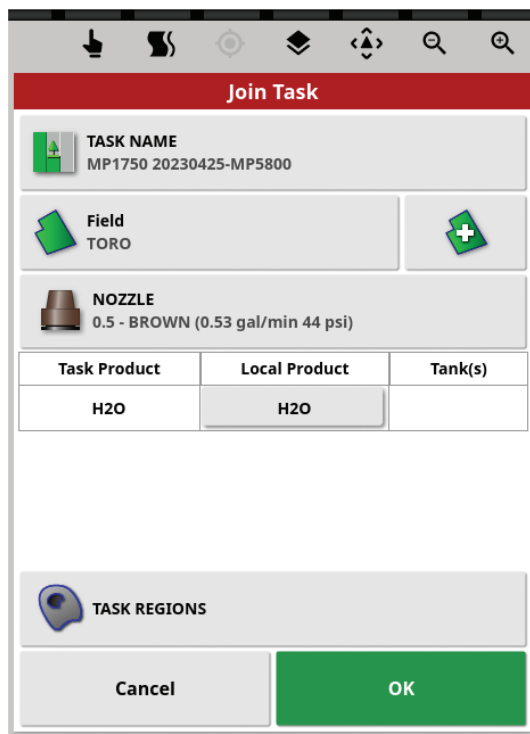

Figure 102

g442410

3. Press OK to join the task.

Note: A notification will be sent to the machine that started the task.

Using MachineLink

1. Machines will have a symbol to show if they are connected or not.

Note: The Wi-Fi antenna will connect up to 0.4 km (0.25 mile).

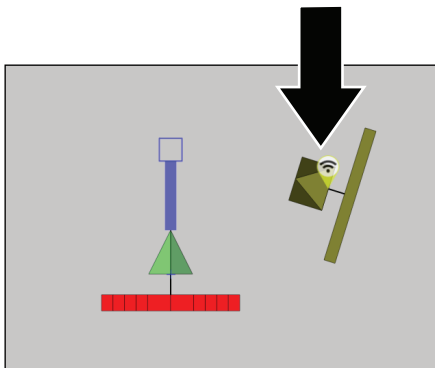

Figure 103

g442409

2. Press and **hold** the icon on the machine to display:

Note: If the Wi-Fi connection is lost, the machine icon will show that it is disconnected and it stay in the last connected position until connection is regained.

When the Wi-Fi connects, the machine appears in the actual position and the display will show the updated shared coverage.

- The console name
- The status and any connection issues
- Which products are being applied
- The areas that have been covered

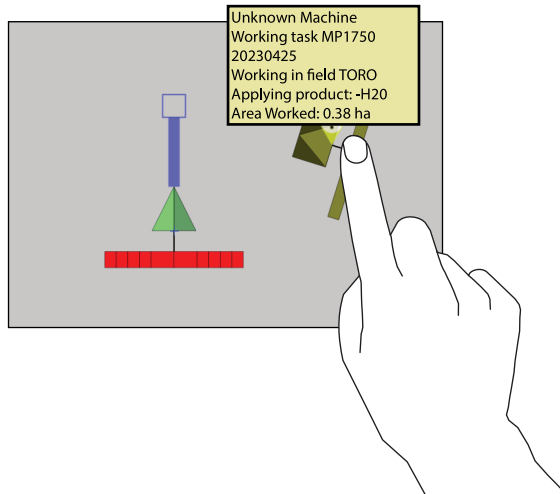

Figure 104

g442421

Shared Coverage

Local coverage displays as a light green.

Shared coverage displays as a dark green. Press the machine icon to highlight the shared coverage in a different shade to show the specific coverage from that implement.

Creating a 'boundary from coverage' uses the local and shared coverage to form the boundary.

The application rate can be selected as a coverage option. Since all machines shares the same coverage legend, they will have the same application rate map.

If you change fields or tasks on a display but then go back to the previous shared task, the shared coverage will not show up unless the other machines are still operating in that field or they reload the shared task.

If a machine leaves the shared coverage field, that machine's coverage will still be displayed.

Note: The total covered area only displays the area covered from the local implement. The remaining area calculated within a boundary will not factor in the shared coverage.

Configuring Skybridge Settings

1. Press the SETUP menu.
2. Navigate to the GPS CORRECTION SOURCE menu via SYSTEM – GPS – CORRECTION.
3. Select GNSS and choose GPS, GLONASS, BEIDOU, AND GALILEO.

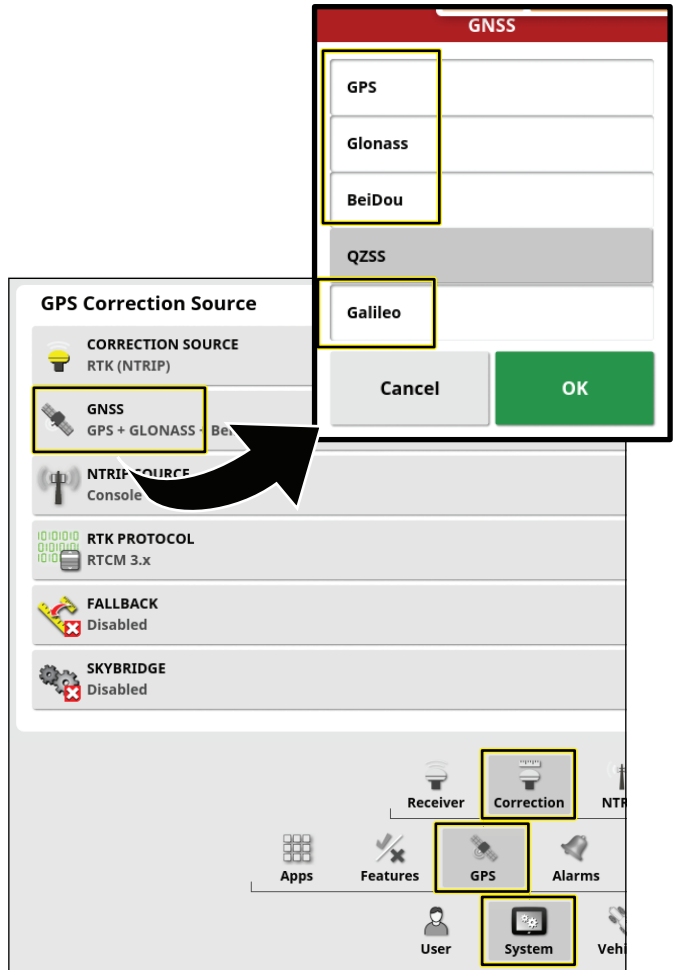

Figure 105

g487158

4. Select SKYBRIDGE and choose ENABLED.

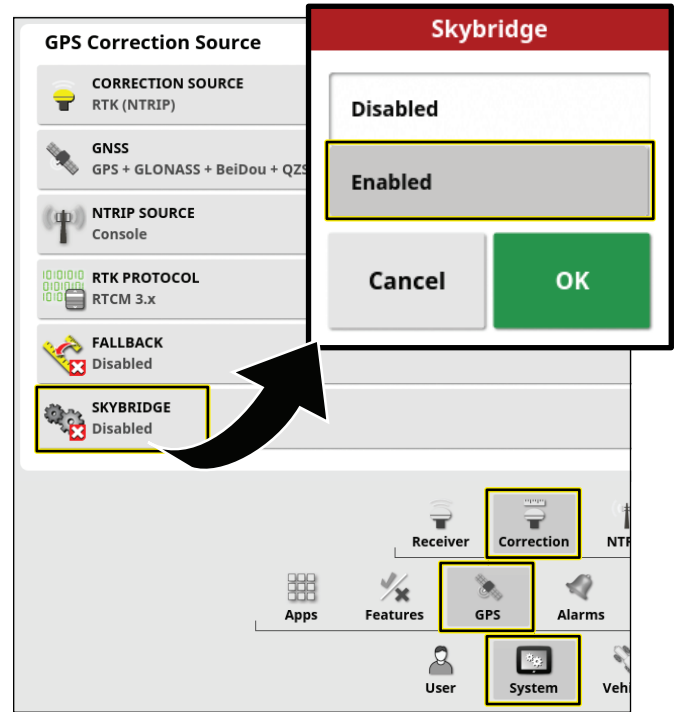

Figure 106

g487159



Figure 107

g442422

5. Drive the machine to an open area and ensure that RTK is displayed on the dashboard.



Figure 108

g443523

- Skybridge will converge within 30 to 40 minutes and RTK + SKYBRIDGE will display on the dashboard.



g443522

Figure 109

During operation, the dashboard displays the current correction status based on the strongest signal (RTK, Skybridge, Float RTK, or GPS) available at the given time and location.

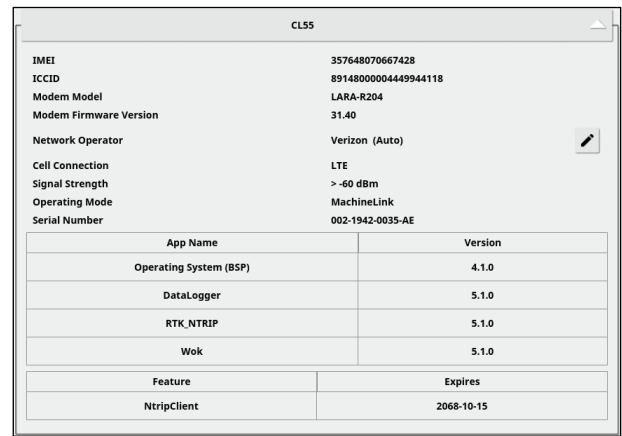

g431463

Figure 111

Technical Assistance

For many errors an error code, or fault code, will display. It is also possible to view the errors on the screen. Some errors are common and are correctable. For other errors or if a problem persists, always record the error message including any code displayed and report to your distributor or Contact your authorized Toro distributor or Toro GeoLink Support.

Identifying System Information

- Press the System Information (Toro) icon at the top, left corner of the screen.

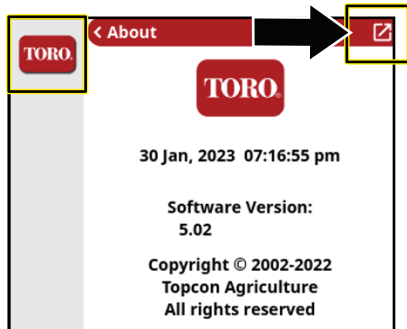

g431462

Figure 110

- In the system information mini-view window, press the full-screen icon.
- Use the scroll bar to view the following types of system information details:
 - Console
 - GPS receiver
 - Steering controller (optional kit)
 - Wireless network

Verifying the RTK and Correction Information

1. Move the machine outdoors, away from buildings and power lines.
2. Engage the parking brake.
3. On the GeoLink control console, press the GPS INFORMATION icon.

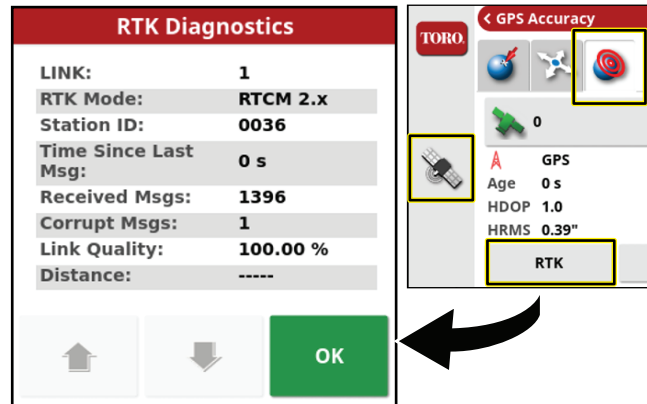

Figure 112

g431469

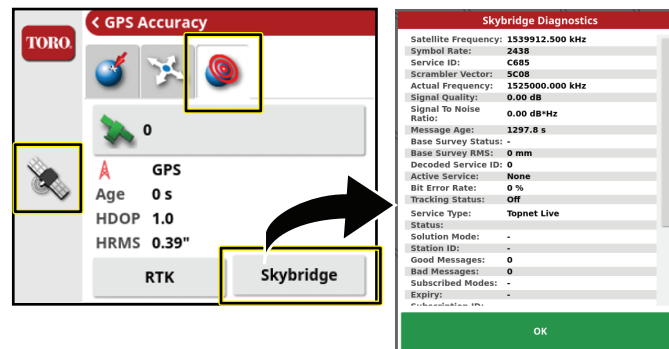

Figure 113

g433800

4. Press the RTK icon, and verify in the RTK diagnostics dialogue box that the RTK link quality is 50% or greater.
5. Press the confirm icon to close the dialog box.

Note: If the modem signal is equal to or less than -100 dBm, Contact your authorized Toro distributor or Toro GeoLink Support.

If RTK link quality is less than 50%, Contact your authorized Toro distributor or Toro GeoLink Support.

Remote Assist

Entering a Support Desk PIN

1. Contact Toro support to request a desk PIN code.
2. In the setup screen, press the USER icon, and press the REMOTE SUPPORT icon.

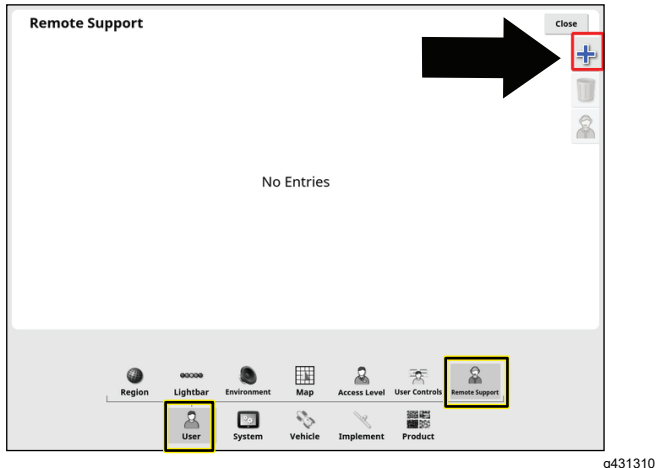

Figure 114

g431310

3. If no support desk entries appear in the remote support window, press the ADD SUPPORT DESK icon.
4. Press the DESK PIN icon.

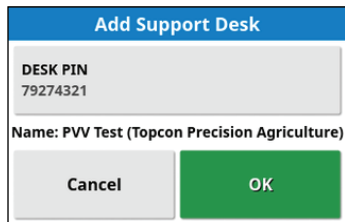

Figure 115

g431311

5. Enter the PIN code.
6. In the Add Support Desk screen, press the confirm icon.

Note: The control console saves the support desk information to memory.

Connecting to the Support Desk Personnel

1. Press the SUPPORT DESK icon for customer service, saved to the support desk list.

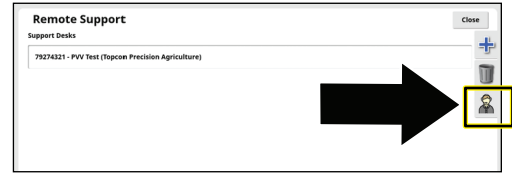

Figure 116

g431312

2. Press the REQUEST SUPPORT FROM DESK icon.
The request support screen dialog box appears, then the support session active dialog box appears.

Note: The customer service representative remotely connects to the control console.

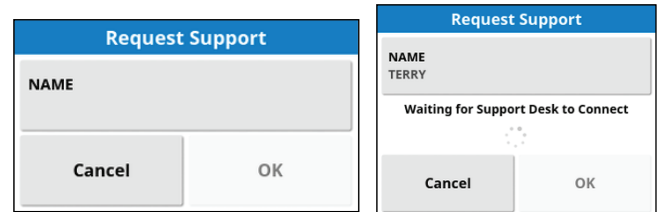

Figure 117

g431313

Operating Tips

Improving the RTK Correction

Reduce the machine speed, or approach from another direction, when you are approaching an area with known RTK correction difficulty.

Using the Manual Control

To boost pressure for the hose reel and mixing chemicals, use the manual control to boost pressure.

Improving the Application Rate Response Time

Multi Pro 5800 Machines

Set the agitation PWM (preset agitation value) to approximately 69 kPa (10 psi) above the target-spraying pressure.

Creating a Backup File of the Display Data

Refer to [Using the Inventory Manager \(page 25\)](#).

Cleaning the Display Screen

Clean the screen, when needed, with mild soap and water.

Note: Avoid using window cleaners and any cleaners with solvents.

Troubleshooting

Problem	Possible Cause	Corrective Action
There is no power to the display.	<ol style="list-style-type: none"> 1. The harness connectors are not installed correctly. 2. The in-line fuse (10 A) for the control console is open (blown). 3. The battery connections are loose. 	<ol style="list-style-type: none"> 1. Ensure that the connectors are installed correctly at the back of the control console. 2. Replace the fuse. 3. Secure the battery connections.
The sprayer does not spray.	<ol style="list-style-type: none"> 1. The master-control switch for the machine is shut off. 2. The section switch(es) on the console of the machine are off. 3. No job and field boundary are created. 4. The incorrect nozzle is selected in sprayer-control setup menu. 	<ol style="list-style-type: none"> 1. Ensure that the master-control switch for the machine is set to the ON position. 2. Ensure that the switches on the console are set to the ON position. 3. Create a job and field boundary. 4. Select the correct nozzle in sprayer-control setup menu that matches the nozzles being used.
The No GPS alarm is on.	<ol style="list-style-type: none"> 1. The control console is not connected to GPS receiver correctly. 2. The machine is under trees or other obstructions. 	<ol style="list-style-type: none"> 1. Ensure that the connections are installed correctly. 2. Allow the machine to make connection after driving under obstructions.
The sprayer sprays outside boundaries.	<ol style="list-style-type: none"> 1. The auto section control (ASC) is set to unlimited. 	<ol style="list-style-type: none"> 1. Set the auto section control (ASC) to field boundary.
You cannot create boundaries.	<ol style="list-style-type: none"> 1. The display is not in standard mode. 2. There is no field created. 	<ol style="list-style-type: none"> 1. Switch the user profile to standard mode. 2. Create a field.
The machine is not shown on the screen.	<ol style="list-style-type: none"> 1. The display screen has been moved. 2. The machine may not have GPS signal because the machine is inside a building. 3. The machine may not have GPS signal because the machine lost the connection to the satellite receiver. 	<ol style="list-style-type: none"> 1. Select the center-map icon on the main screen. 2. Move the machine outside to an area clear of tall buildings and trees. 3. Check the status light on the satellite receiver. Check the wire harnesses to the satellite receiver.
The lights are not blinking on the GPS receiver located on the ROPS.	<ol style="list-style-type: none"> 1. There is no power to the GPS receiver. 	<ol style="list-style-type: none"> 1. Ensure that the connectors are installed correctly.
The pressure is not high enough.	<ol style="list-style-type: none"> 1. The nozzle size used is incorrect. 2. The nozzle size selected in the display does not match the nozzles on the boom sections. 3. The agitation is set too low. 	<ol style="list-style-type: none"> 1. Refer to the nozzle selection chart for the proper nozzle sizing. 2. Ensure that the nozzle size selected in the command console matches the installed boom-section nozzles. 3. Adjust the agitation until the desired pressure is realized.
The controller lights not on at the ASC 10 controller.	<ol style="list-style-type: none"> 1. There is no power to the ASC 10 controller. 	<ol style="list-style-type: none"> 1. Ensure that the connectors are installed correctly.
The speed is not displayed in the control console when the machine is moving.	<ol style="list-style-type: none"> 1. The compass is not calibrated. 2. The receiver lacks satellite reception. 3. The vehicle ground speed is less than 0.16 km/h (0.1 mph). 	<ol style="list-style-type: none"> 1. Calibrate the compass. 2. Drive away from reception obstructions and allow time for the receiver to connect to the satellites. 3. Increase the speed above 0.16 km/h (0.1 mph).

Problem	Possible Cause	Corrective Action
There is condensation inside the display of the control console.	1. The display warms up too quickly in direct sunlight with the display set at 100 percent brightness.	1. Change the screen brightness to 85 percent and allow the display to warm up.
The control console displays a crash report notification.	1. Improperly powering down the console display.	1. Clear the crash report from Inventory Manager. Always use the keys switch to shutoff the console display.



Count on it.