



Count on it.

Parts Catalog

**Power Max[®] 826 OAE
Snowthrower**

Model No. 37799—Serial No. 416180000 and Up



Ordering Replacement Parts

To order replacement parts, please supply the part number, the quantity, and the description of each part desired.

Understanding Reference Numbers

Each identified part in an illustration has a reference number. The reference number for a part also appears in the parts list, along with other information about the part.

This catalog uses two special reference number formats, one to indicate parts in a service assembly and another to indicate the quantity of a given part in an illustration.

Service Assembly Reference Numbers

Parts in service assemblies have reference numbers in the form a:b. The a represents the reference number of the entire service assembly and the b represents a sequential number unique to each part within the service assembly.

For example, a wheel assembly might be identified by reference number 6, the tire by 6:1, the valve by 6:2, and the wheel by 6:3. When you order the assembly identified by reference number 6, you receive all parts identified by reference numbers 6:1, 6:2, and 6:3. However, you may also order any part individually. Reference numbers of this type appear in illustration and in parts lists.

Reference Numbers Indicating Quantity

In an illustration, if a reference number indicates more than one part, the reference number has the form nX y. The n represents the quantity of the part, the X is the multiplication symbol, and the y represents the reference number.

For example, in an illustration, the reference number 2X 37 means that two of the parts identified by reference number 37 are indicated.

Contents

Main Frame and Auger Housing Assembly	4
Pulley and Bellcrank Assembly	6
Impeller Drive Assembly	8
Drive Assembly	10
Tire and Drive Assembly	12
Gearbox, Auger and Impeller Assembly	14
26 Inch Auger Gearcase Assembly No. 119-7641	16
Impeller Assembly	18
Engine Assembly	20
Fuel System and Carburetor Assembly	22
Intake and Exhaust Assembly	24
Ignition and Electrical Assembly	26
Crankcase Assembly	28
Governor Assembly	30
Piston and Head Assembly	32
Blower Housing and Shrouds Assembly	34
Engine Decal Assembly	36
Chute Assembly	38
Lever Chute Control Assembly	40
Handle Assembly	42
Control Assembly	44
Attachments and Accessories	46

Main Frame and Auger Housing Assembly

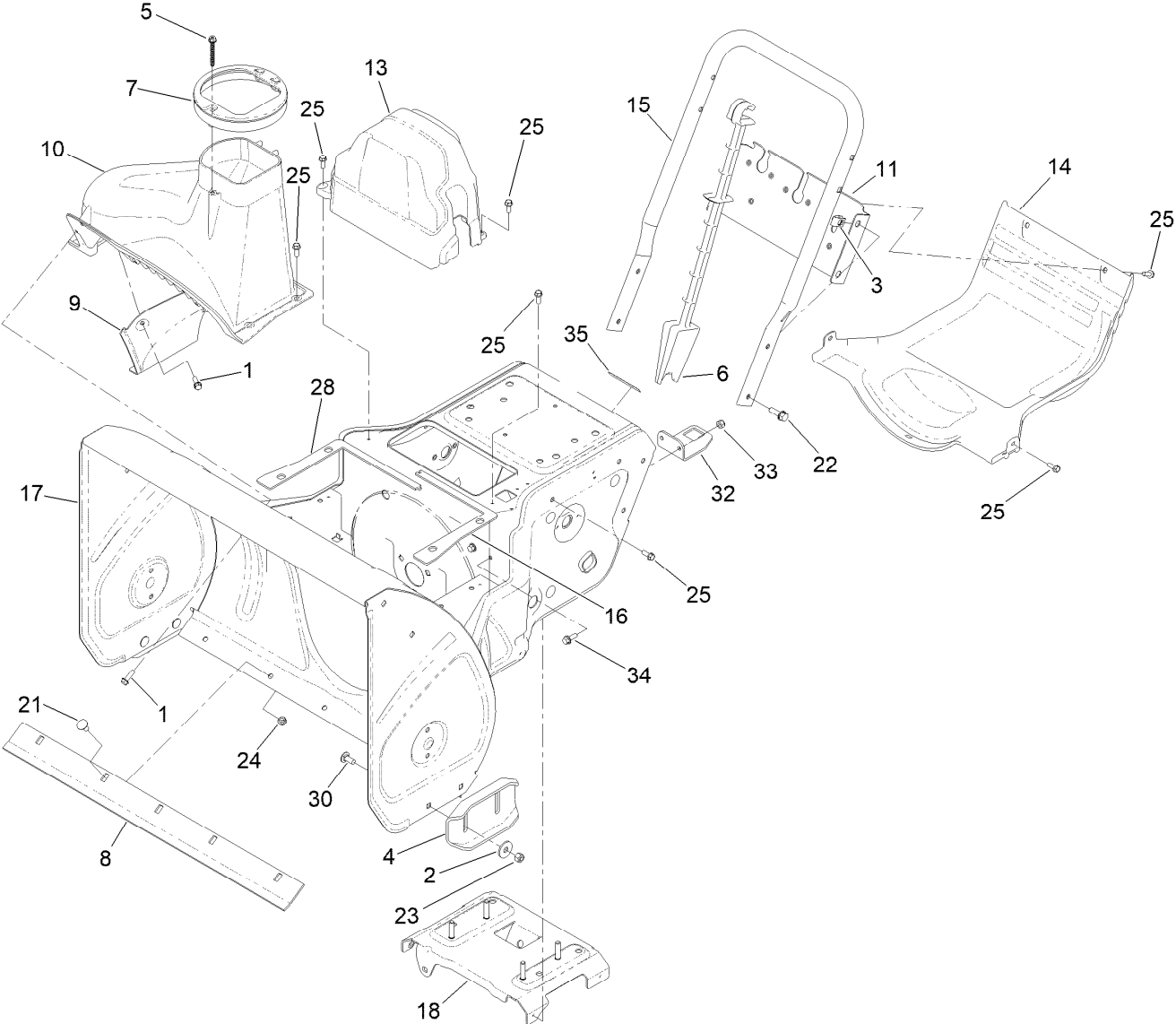

Main Frame and Auger Housing Assembly (continued)

<i>Ref.</i>	<i>Part Number</i>	<i>Qty.</i>	<i>Description</i>	<i>Ref.</i>	<i>Part Number</i>	<i>Qty.</i>	<i>Description</i>
1	46-8091	6	Screw-HWH	16	120-7181	1	Seal-Housing, LH
2	52-2861	4	Washer	17	139-3691	1	Frame ASM
3	94-2413	4	Nut-U	18	136-7187	1	Brace-Frame
4	106-4588-01	2	Skid	21	3230-18	5	Screw-CARR
5	114-3751	1	Screw-HWH, Plastite	22	3234-29	4	Screw-HHF
6	121-6833	1	Stick-Cleanout	23	3296-29	4	Nut-Lock, NI
7	138-3608	1	Guide-Chute	24	3296-47	5	Nut-Lock,NI
8	120-3872-01	1	Scraper-26 Inch	25	32144-85	17	Screw-HWH Thd Form
9	120-7158-01	1	Cover-Liner	28	121-6841	1	Seal-Housing, RH
10	120-7159	1	Cover	30	3230-23	4	Bolt-CARR
11	120-7161-01	1	Brace-Frame	32	137-3410-03	1	Bracket-Post, Chute
13	120-7177	1	Cover-Belt	33	120-9678	2	Screw-HHF
14	120-7178	1	Cover-Lower	34	137-3094	2	Nut-Hex
15	140-3740-03	1	Handle-Lower, Cts	35	133-8061	1	Decal-Warning

Pulley and Bellcrank Assembly

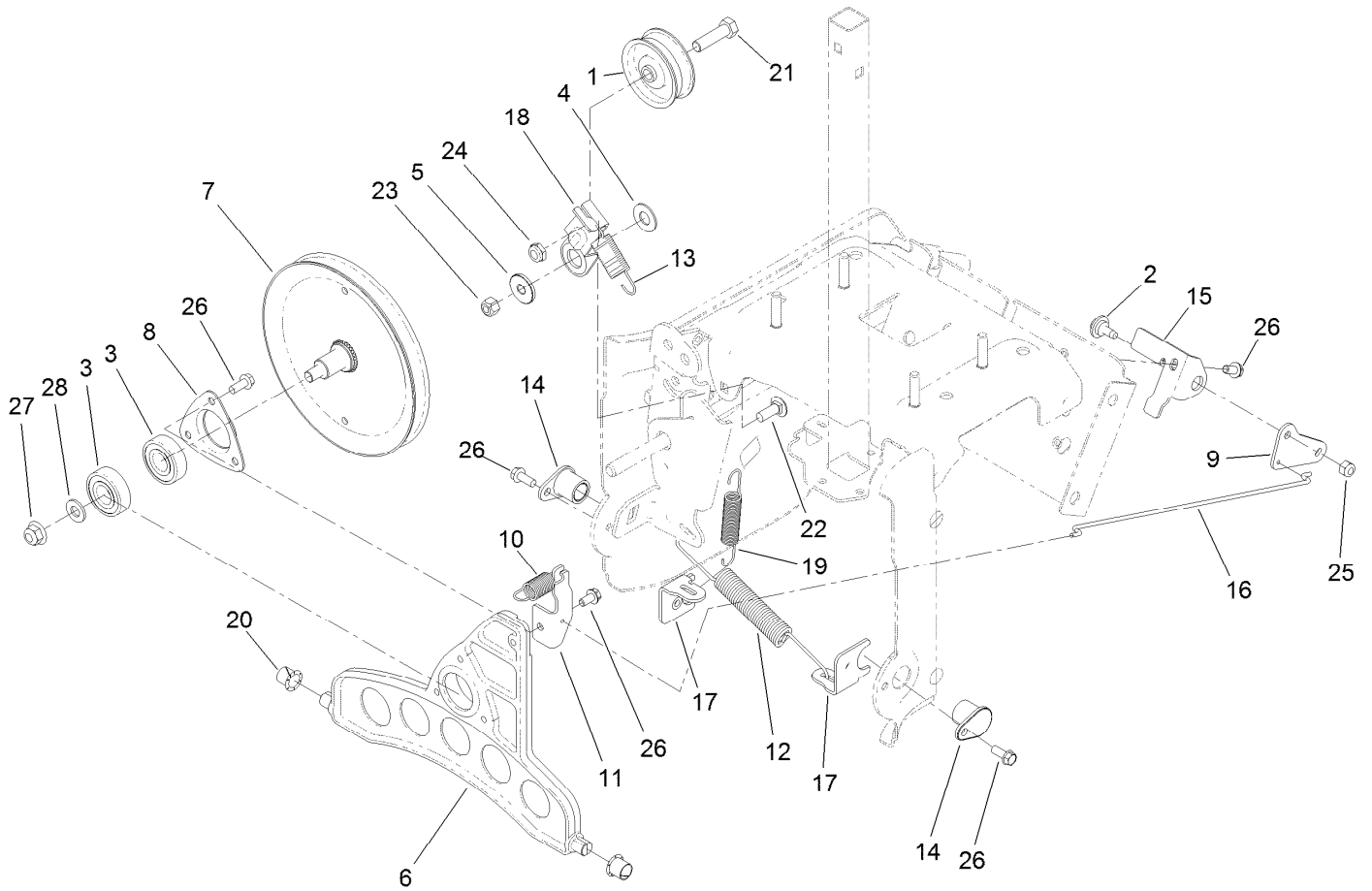

Pulley and Bellcrank Assembly (continued)

<i>Ref.</i>	<i>Part Number</i>	<i>Qty.</i>	<i>Description</i>	<i>Ref.</i>	<i>Part Number</i>	<i>Qty.</i>	<i>Description</i>
1	3-4244	1	Pulley-Idler	15	120-7165-03	1	Bracket-Bellcrank
2	92-9698	1	Screw-Shoulder	16	136-7155	1	Link-Drive
3	38-7820	2	Bearing-Ball	17	120-9271	2	Bracket-Anchor, Spring
4	25-5640	1	Washer	18	136-7159	1	Arm-Idler, Traction
5	117-7711	1	Bushing-Idler	19	120-9275	1	Spring-Extension
6	119-7645	1	Plate-Wheel, Friction	20	256-257	2	Bushing-Nyliner
7	136-7152	1	Traction Pulley ASM	21	323-29	1	Screw-HH
8	136-7124	1	Retainer-Bearing	22	3230-10	1	Bolt-CARR
9	119-7670-03	1	Bellcrank-Drive	23	3296-29	1	Nut-Lock, NI
10	136-7153	1	Spring-Extension	24	3296-59	1	Nut-Lock, NI
11	119-7679	1	Bracket-Plate, Traction	25	3296-73	1	Nut-Lock, NI
12	120-3883	1	Spring-Extension	26	32144-85	7	Screw-HWH Thd Form
13	137-3435	1	Spring-Extension	27	104-8301	1	Nut-HF, NI
14	120-7156	2	Bushing-Plate, Traction	28	3256-24	1	Washer-Plain

Impeller Drive Assembly

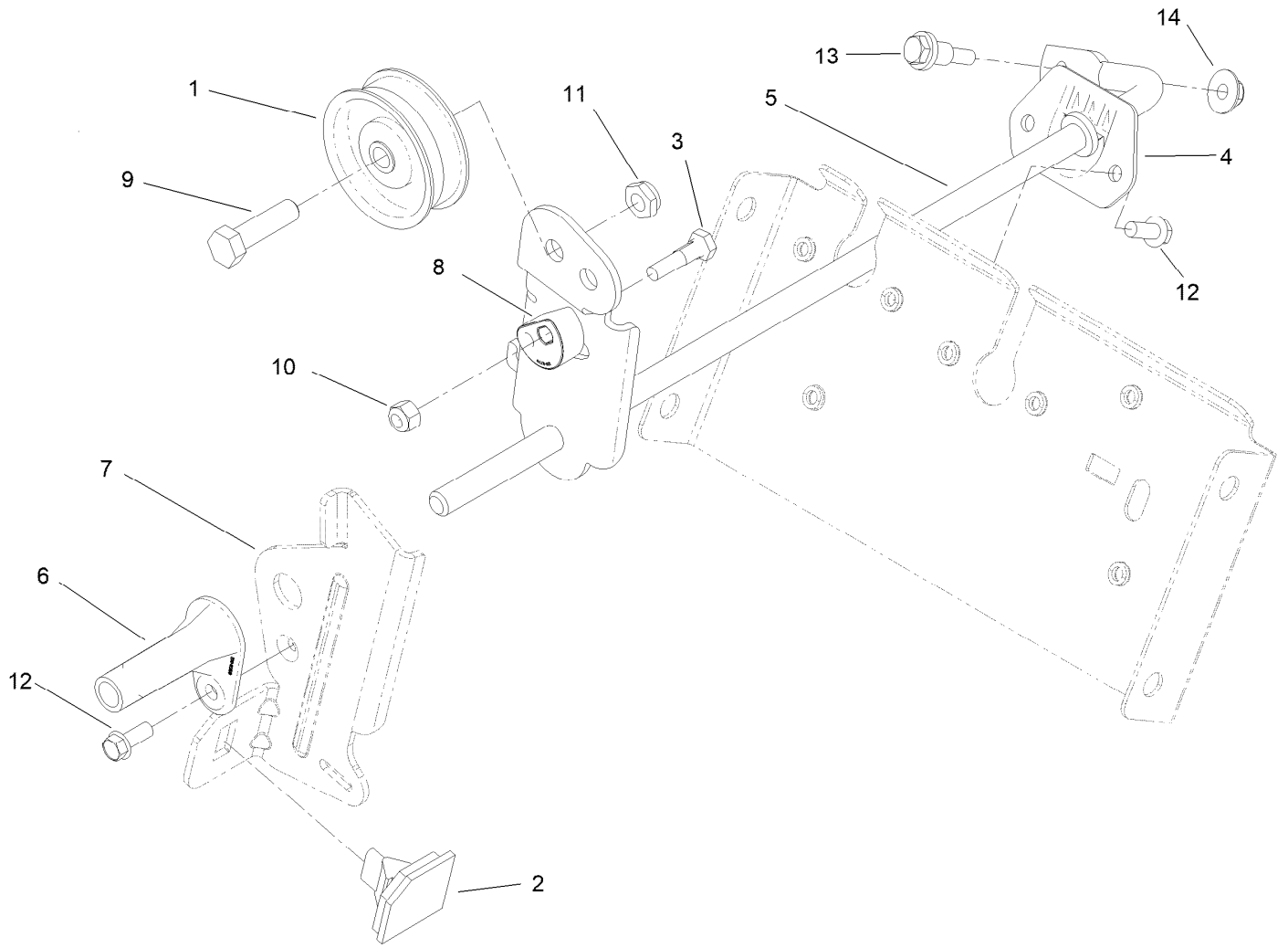

Impeller Drive Assembly (continued)

<i>Ref.</i>	<i>Part Number</i>	<i>Qty.</i>	<i>Description</i>	<i>Ref.</i>	<i>Part Number</i>	<i>Qty.</i>	<i>Description</i>
1	3-4244	1	Pulley-Idler	8	120-9276	1	Eccentric-Brake, Impeller
2	66-8060	1	Pad-Brake	9	323-29	1	Screw-HH
3	136-8674	1	Bolt-Pivot, Eccentric	10	3296-42	1	Nut-Lock, NI
4	120-7167	1	Bushing-Rod, Clutch	11	3296-59	1	Nut-Lock, NI
5	120-9254-03	1	Impeller Clutch ASM	12	32144-85	3	Screw-HWH Thd Form
6	120-9256	1	Pivot-Brake, Impeller	13	104-0858	1	Bolt-Shoulder
7	120-9257-03	1	Arm-Brake, Impeller	14	137-3016	1	Nut-HF

Drive Assembly

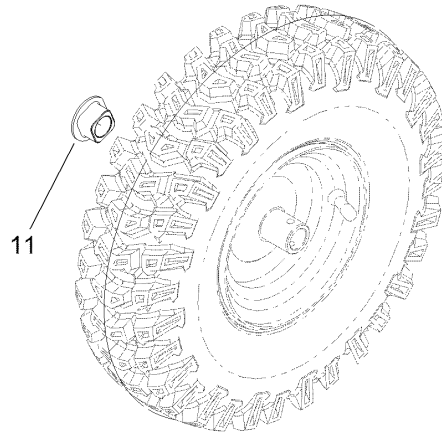
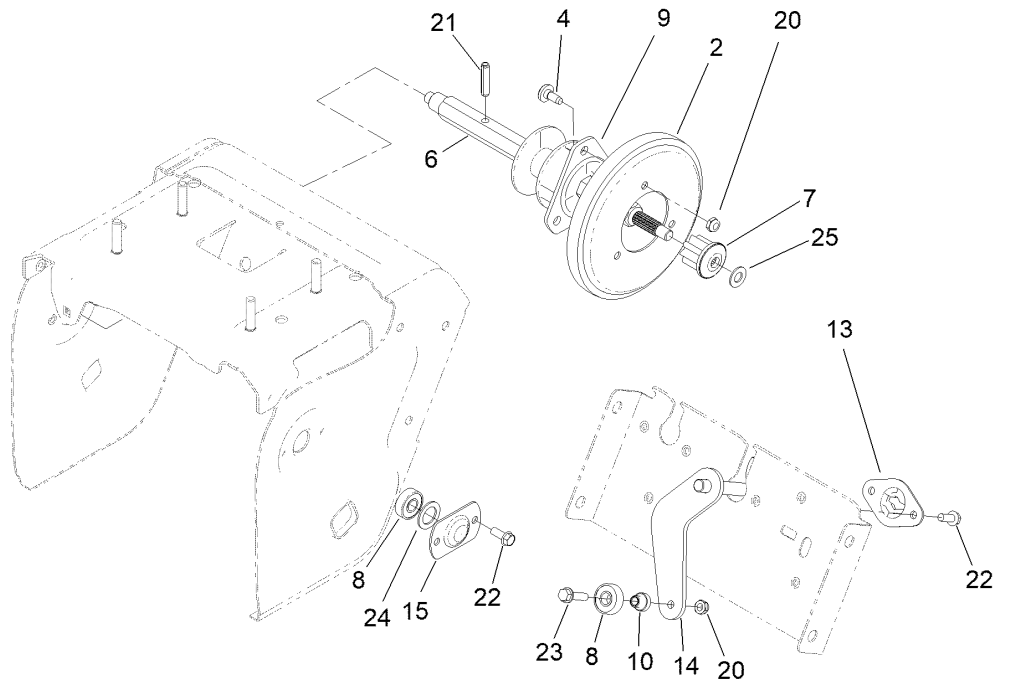
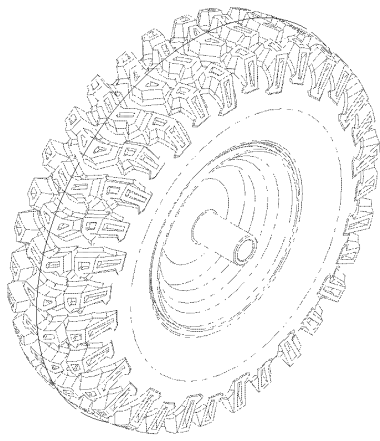

Drive Assembly (continued)

<i>Ref.</i>	<i>Part Number</i>	<i>Qty.</i>	<i>Description</i>	<i>Ref.</i>	<i>Part Number</i>	<i>Qty.</i>	<i>Description</i>
2	119-1567	1	Wheel-Friction	14	120-7193-03	1	Shift Plate ASM
4	120-7950	3	Screw-Torx	15	136-7158	2	Retainer-Bearing
6	140-3745	1	Shaft-Hex	20	3296-56	4	Nut-Lock, NI
7	119-7616	1	Gear-Pinion, 8 Tooth	21	32121-9	1	Pin-Roll, Slotted
8	121-6835	3	Bearing-Ball	22	32144-85	6	Screw-HWH Thd Form
9	119-7630	1	Trunnion	23	32144-86	1	Screw-HWHTF
10	119-7684	1	Spacer-Plate, Shift	24	121-6840	2	Washer-Rubber
11	120-7162	2	Bushing-Axle	25	145-0743	1	Washer-Flat
13	120-7191	1	Retainer-Plate, Shift				

Tire and Drive Assembly

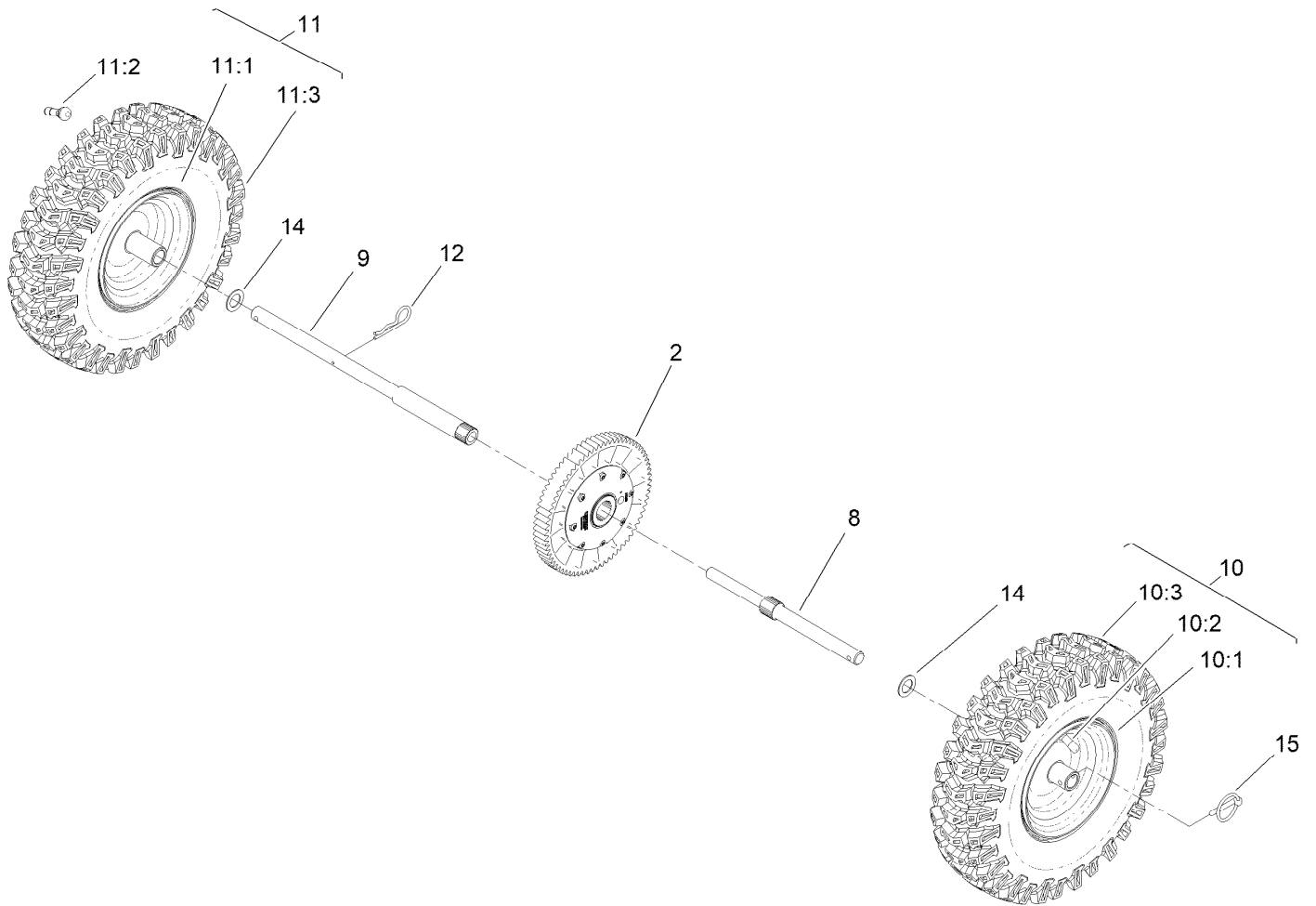

Tire and Drive Assembly (continued)

<i>Ref.</i>	<i>Part Number</i>	<i>Qty.</i>	<i>Description</i>	<i>Ref.</i>	<i>Part Number</i>	<i>Qty.</i>	<i>Description</i>
2	140-3747	1	Transmission-Gt, Di200	11	138-3659	1	RH Wheel And Tire ASM
8	140-3746	1	Axle-Lt, Cts	11:1	138-3669	1	Wheel (15X4 Tire)
9	140-3742	1	Axle-Rt, Cts	11:2	232-27	1	Stem-Valve
10	138-3660	1	LH Wheel And Tire ASM	11:3	138-3668	1	Tire
10:1	138-3669	1	Wheel (15X4 Tire)	12	3290-343	1	Pin-Hair
10:2	232-27	1	Stem-Valve	14	3-8664	2	Washer-Thrust
10:3	138-3668	1	Tire	15	107-3039	2	Pin-Lynch

Gearbox, Auger and Impeller Assembly

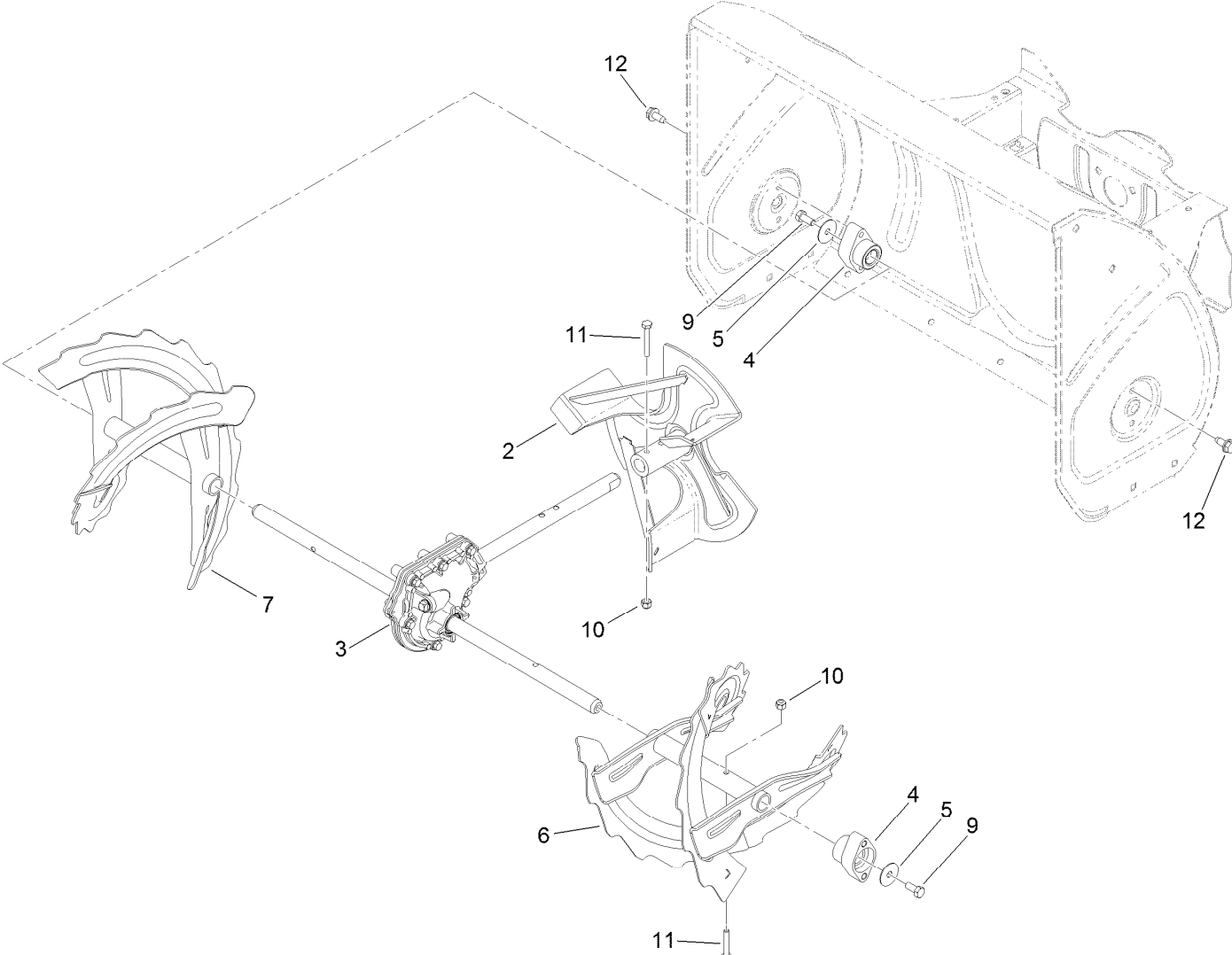

Gearbox, Auger and Impeller Assembly (continued)

<i>Ref.</i>	<i>Part Number</i>	<i>Qty.</i>	<i>Description</i>	<i>Ref.</i>	<i>Part Number</i>	<i>Qty.</i>	<i>Description</i>
2	119-7612-03	1	Impeller ASM	7	120-9290-03	1	RH Auger ASM
3	119-7641	1	Gearcase ASM	9	322-3	2	Screw-HH
4	120-3860	2	Bearing-Augur	10	3296-42	4	Nut-Lock, NI
5	120-3862	2	Washer-Thrust	11	321-10	4	Screw-HH
6	120-9287-03	1	LH Auger ASM	12	32144-70	4	Screw-HWHTF

26 Inch Auger Gearcase Assembly No. 119-7641

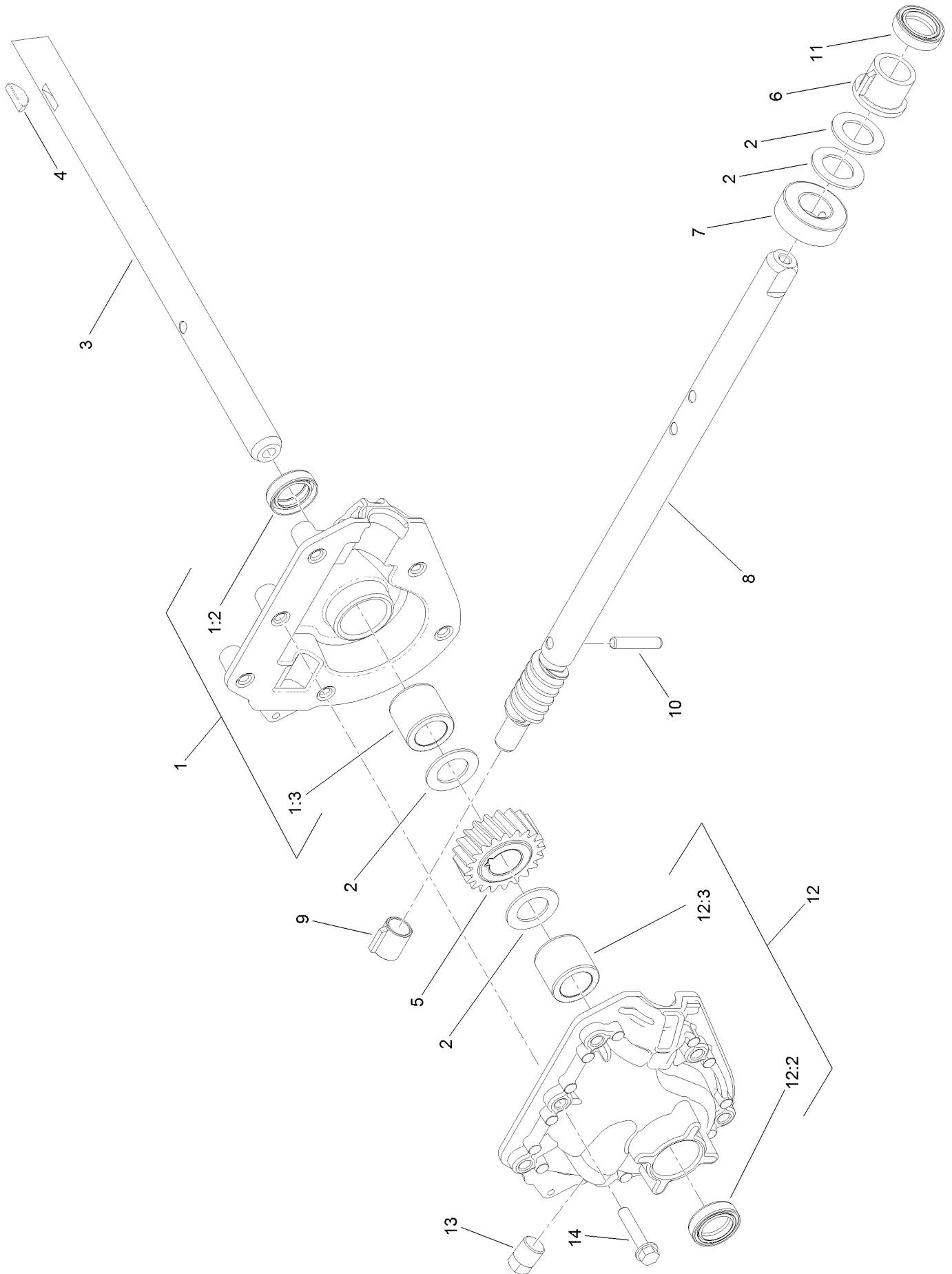

26 Inch Auger Gearcase Assembly No. 119-7641 (continued)

<i>Ref.</i>	<i>Part Number</i>	<i>Qty.</i>	<i>Description</i>	<i>Ref.</i>	<i>Part Number</i>	<i>Qty.</i>	<i>Description</i>
1	121-1209	1	RH Auger Gearcase ASM	8	121-1234	1	Shaft-Impeller, Rolled
1:2	121-6634	1	Seal-Shaft	9	62-1150	1	Bushing-Worm
1:3	120-9269	1	Bushing-Sleeve	10	107-8899	1	Pin-Dowel
2	119-7640	4	Washer-Thrust	11	121-6634	1	Seal-Shaft
3	119-7639	1	Shaft-Output, Auger	12	121-1210	1	LH Auger Gearcase ASM
4	3257-5	1	Key-Woodruff	12:2	121-6634	1	Seal-Shaft
5	119-1576	1	Gear-Helical, 20 Tooth	12:3	120-9269	1	Bushing-Sleeve
6	119-7635	1	Bushing-Input	13	121-6832	1	Plug-Pipe, SQH
7	119-7636	1	Collar-Thrust	14	108-4862	6	Screw-HWH Thd Roll

Impeller Assembly

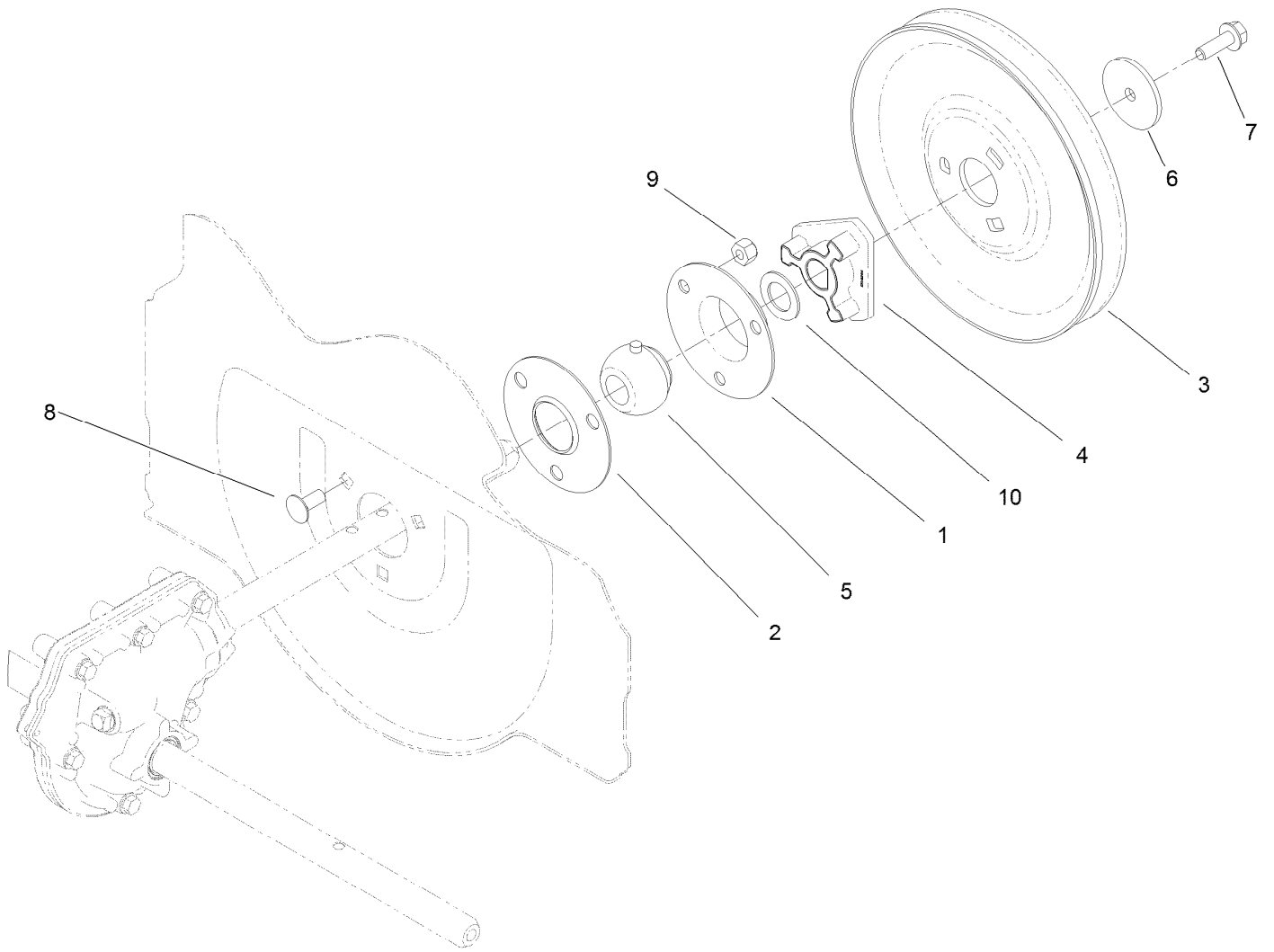

Impeller Assembly (continued)

<i>Ref.</i>	<i>Part Number</i>	<i>Qty.</i>	<i>Description</i>	<i>Ref.</i>	<i>Part Number</i>	<i>Qty.</i>	<i>Description</i>
1	26-6110	1	Flange-Cup, Bearing	6	121-1230	1	Washer-Plain
2	26-6120	1	Flange-Cup, Bearing	7	115-5142	1	Screw-HHF
3	136-7157	1	Pulley-Impeller	8	3230-23	3	Bolt-CARR
4	120-9264	1	Hub-Impeller, Pulley	9	3296-29	3	Nut-Lock, NI
5	120-9272	1	Bearing	10	119-7640	1	Washer-Thrust

Engine Assembly

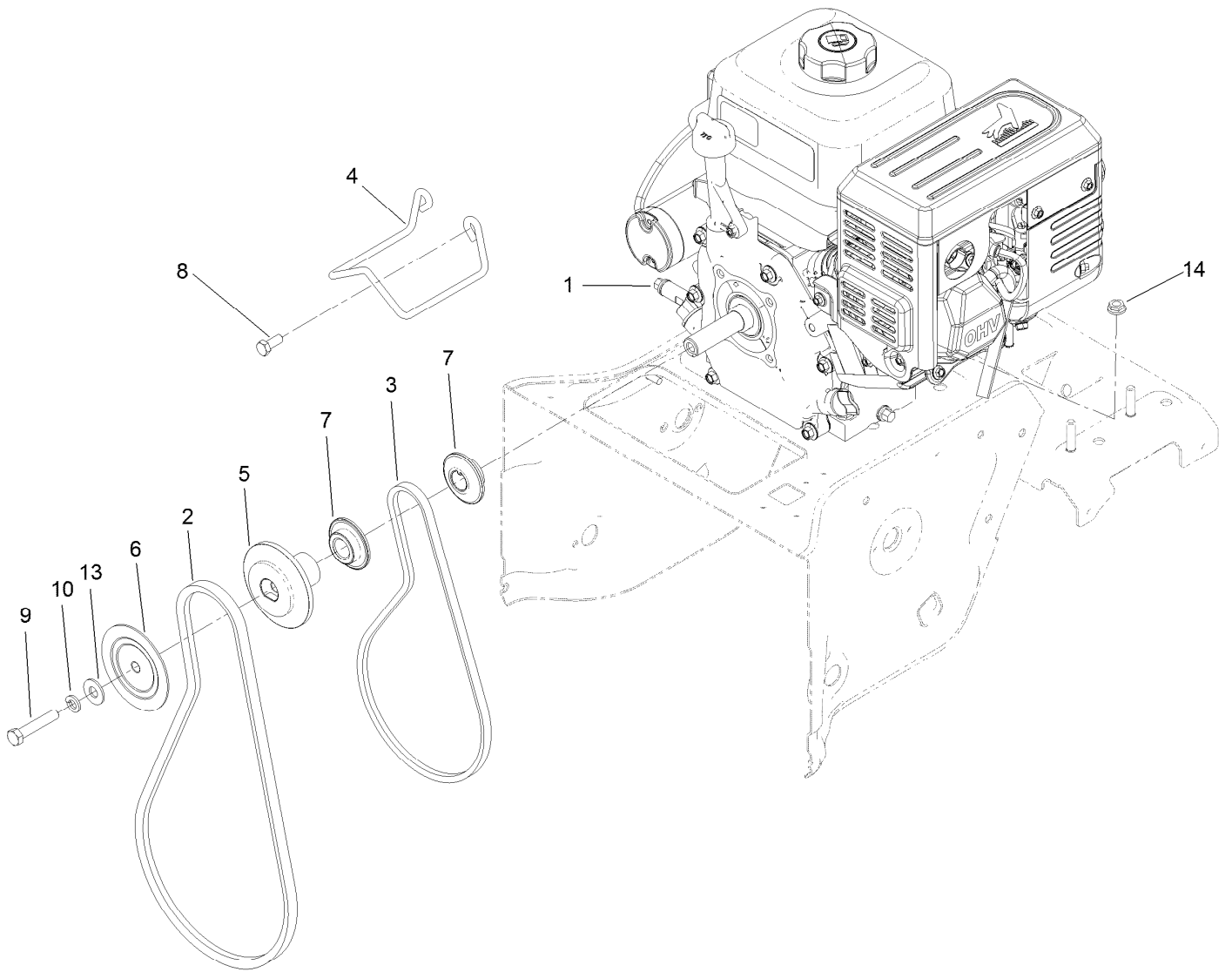

Engine Assembly (continued)

<i>Ref.</i>	<i>Part Number</i>	<i>Qty.</i>	<i>Description</i>	<i>Ref.</i>	<i>Part Number</i>	<i>Qty.</i>	<i>Description</i>
1	147-7057	1	Engine-G250Fds-1	7	137-3400	2	Pulley-Engine, Traction
2	120-3892	1	Belt-V	8	138-0690	2	Screw-HH
3	120-3893	1	Belt-V	9	120-2302	1	Screw-HH
4	136-7156	1	Guide-Belt	10	3253-21	1	Washer-Lock
5	120-9283	1	Pulley-Auger, Rear	13	3256-4	1	Washer-Flat
6	120-9284	1	Pulley-Auger, Front	14	32128-20	4	Nut-HF

Fuel System and Carburetor Assembly

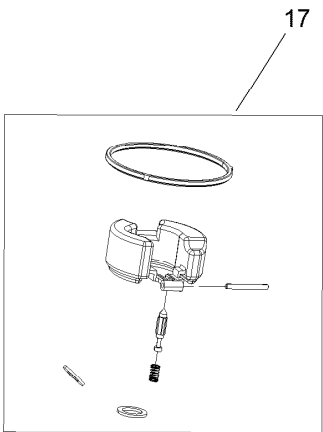
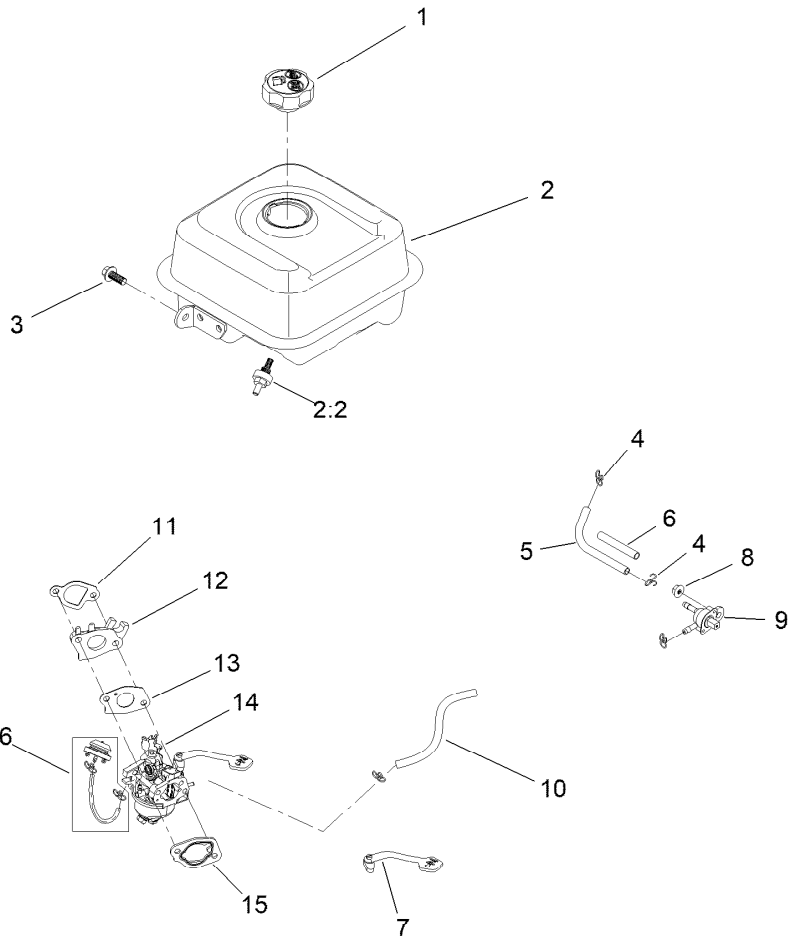

Fuel System and Carburetor Assembly (continued)

<i>Ref.</i>	<i>Part Number</i>	<i>Qty.</i>	<i>Description</i>	<i>Ref.</i>	<i>Part Number</i>	<i>Qty.</i>	<i>Description</i>
1	133-9823	1	Cap-Fuel	10	147-7086	1	Hose-Fuel
2	133-1553	1	Fuel Tank And Filter ASM	11	133-1531	1	Gasket-Carburetor
2:2	127-9065	1	Filter-Fuel	12	133-1532	1	Insulator-Carburetor
3	121-0294	1	Screw-HHF	13	133-1533	1	Gasket-Carburetor
4	147-7077	4	Clip-Hose	14	133-1534	1	Carburetor ASM
5	147-7087	1	Hose-Fuel	15	121-0080	1	Gasket-Carburetor
6	147-7088	1	Sleeve-Abrasion	16	127-9079	1	Primer Kit
7	147-7096	1	Lever-Choke	17	127-9395	1	Internal Carb Service Kit
8	120-4236	1	Nut-Flange	99	133-9937	1	High Altitude Kit ●
9	127-9117	1	Valve-Fuel				

● Not illustrated

Intake and Exhaust Assembly

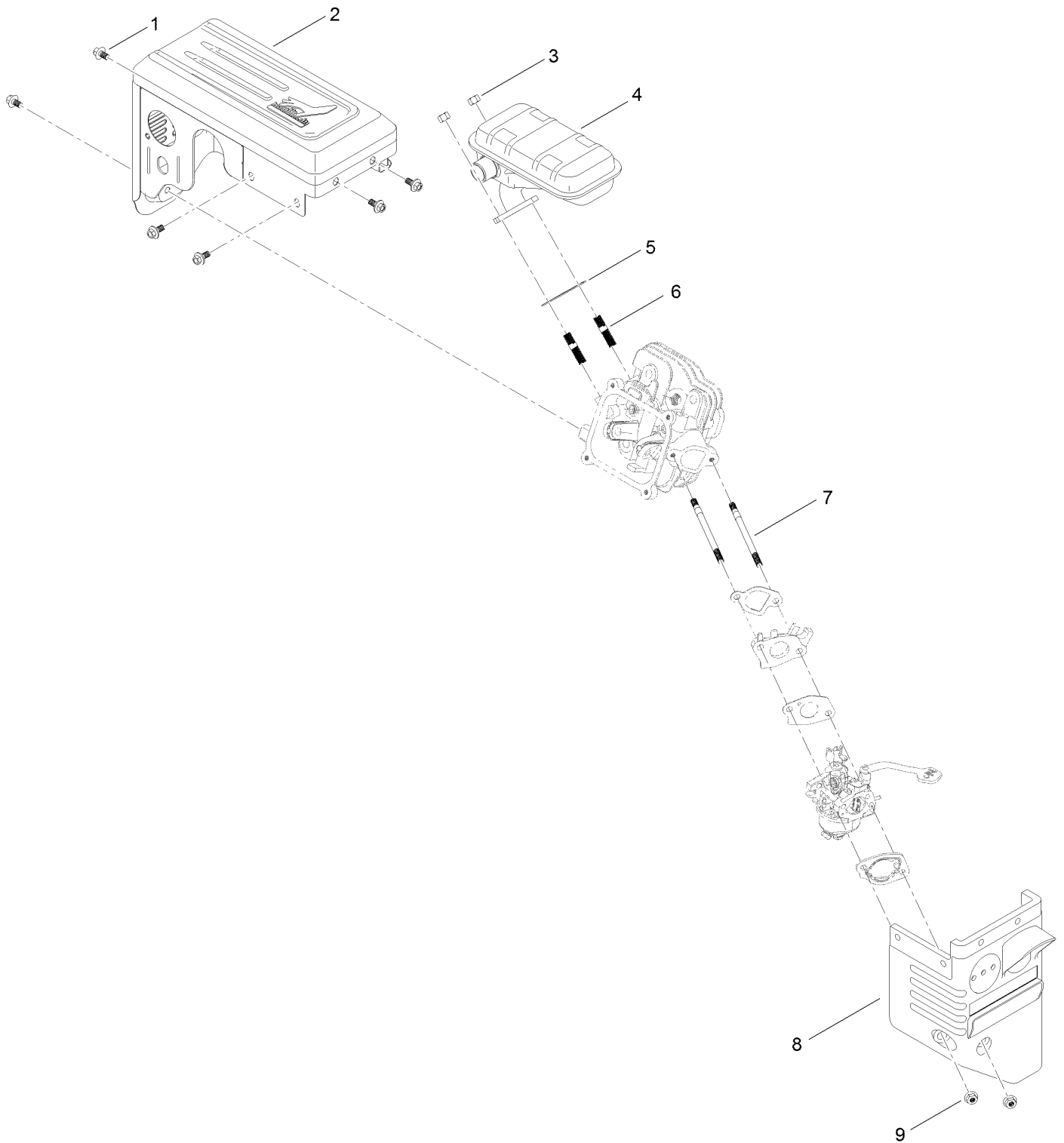

Intake and Exhaust Assembly (continued)

<i>Ref.</i>	<i>Part Number</i>	<i>Qty.</i>	<i>Description</i>	<i>Ref.</i>	<i>Part Number</i>	<i>Qty.</i>	<i>Description</i>
1	121-0294	6	Screw-HHF	6	121-0464	2	Stud-Exhaust
2	127-9491	1	Muffler Cover ASM	7	121-4112	2	Stud-Intake
3	121-0199	2	Nut-HH	8	127-9112	1	Box-Heater
4	127-9490	1	Muffler ASM	9	121-0308	2	Nut-Flange
5	133-1539	1	Gasket-Exhaust				

Ignition and Electrical Assembly

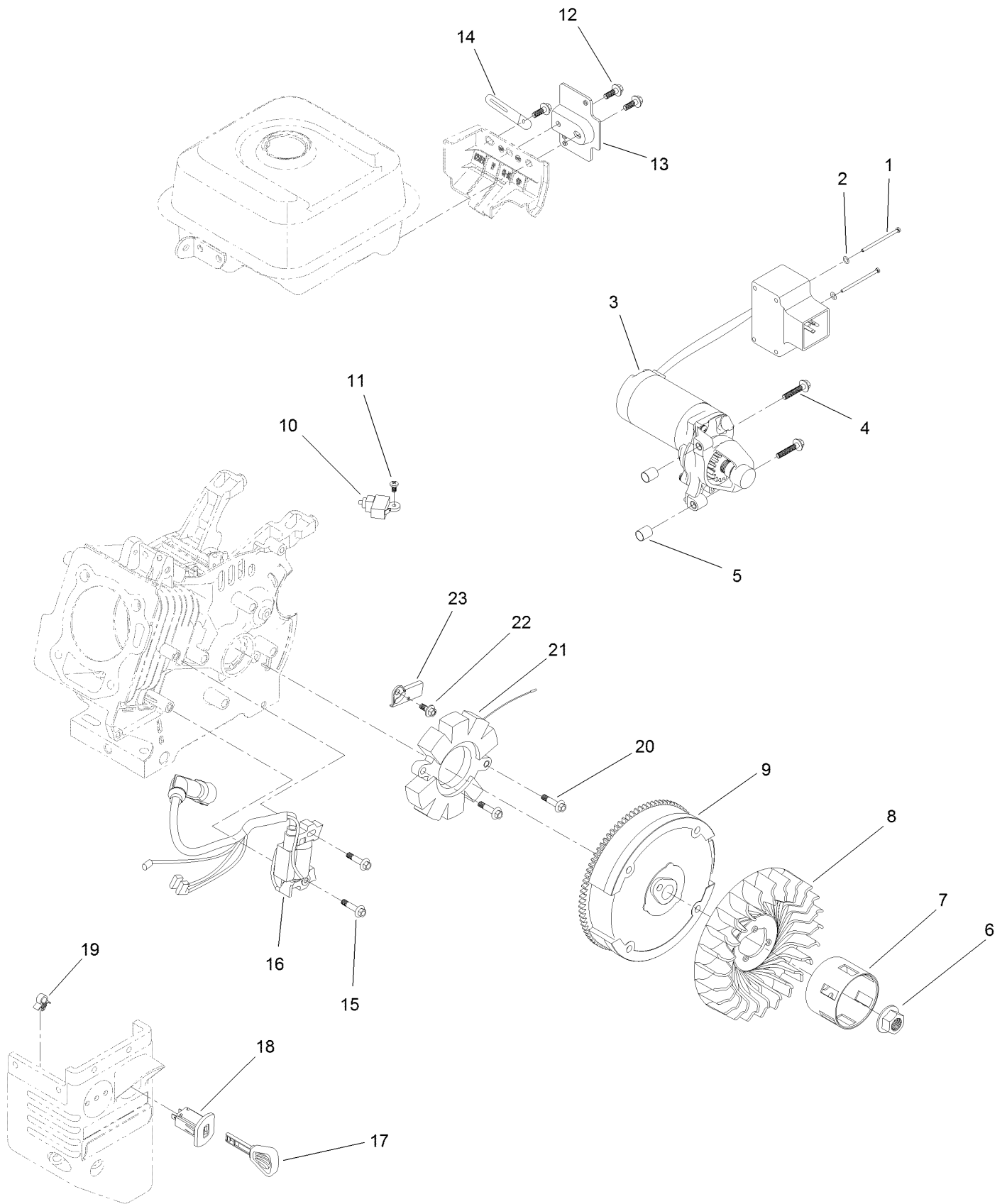

Ignition and Electrical Assembly (continued)

<i>Ref.</i>	<i>Part Number</i>	<i>Qty.</i>	<i>Description</i>	<i>Ref.</i>	<i>Part Number</i>	<i>Qty.</i>	<i>Description</i>
1	121-0306	2	Screw-Bhp	13	133-1554	1	Bracket-Switchbox, Starter
2	121-0312	2	Washer-Plain	14	121-0017	1	Clip-Harness, Wire
3	144-0988	1	Motor-Starter	15	121-0097	2	Screw-HHF
4	133-1546	2	Screw-Flange	16	133-9996	1	Ignition Coil ASM
5	121-0055	2	Pin-Dowel	17	117-7728	1	Key
6	121-0047	1	Nut-Flange	18	121-0283	1	Switch-Key
7	133-1527	1	Cup-Starter	19	121-0326	1	Clip
8	133-1526	1	Fan-Cooling	20	121-0196	2	Screw-HHF
9	127-9484	1	Flywheel ASM	21	127-9485	1	Alternator
10	121-0284	1	Switch-Kill, Engine	22	121-0116	1	Screw-HHF
11	120-4461	1	Screw-PPH	23	127-9486	1	Clamp-Wire, Charge
12	127-9123	3	Screw-HHF				

Crankcase Assembly

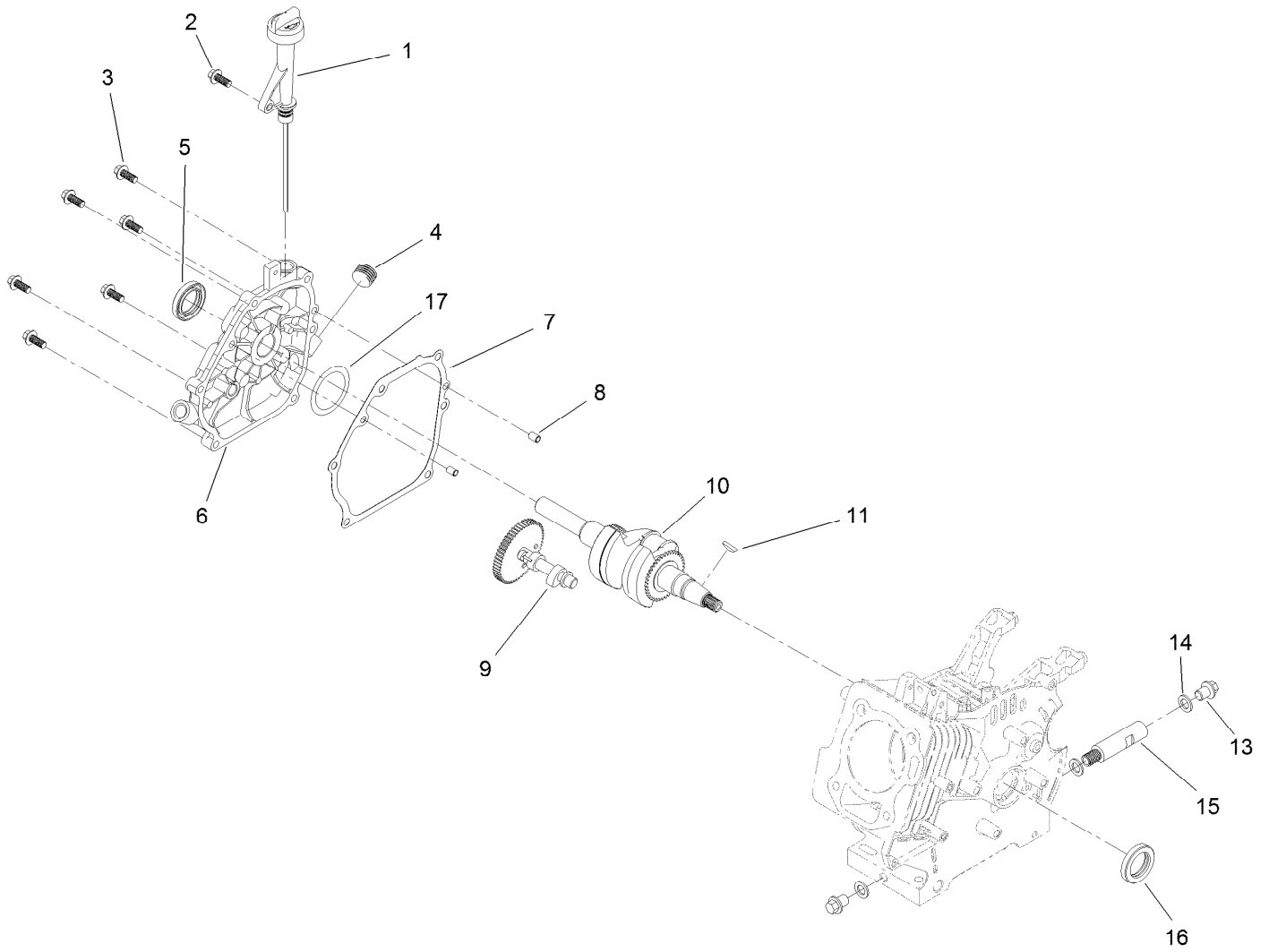

Crankcase Assembly (continued)

<i>Ref.</i>	<i>Part Number</i>	<i>Qty.</i>	<i>Description</i>	<i>Ref.</i>	<i>Part Number</i>	<i>Qty.</i>	<i>Description</i>
1	139-0734	1	Oil Fill ASM	9	133-9991	1	Camshaft ASM
2	127-9123	1	Screw-HHF	10	127-9495	1	Crankshaft
3	121-4114	6	Screw-HHF	11	120-4320	1	Key-Woodruff
4	133-9805	1	Plug-Drain	13	121-0030	2	Screw-HHF
5	133-1516	1	Seal-Oil	14	121-0048	3	Washer-Plain
6	133-9865	1	Cover-Crankcase	15	127-9104	1	Tube-Drain, Oil
7	127-9493	1	Gasket-Cover, Crankcase	16	133-9864	1	Seal-Oil
8	121-0054	2	Pin-Dowel	17	133-9863	1	Washer-Thrust

Governor Assembly

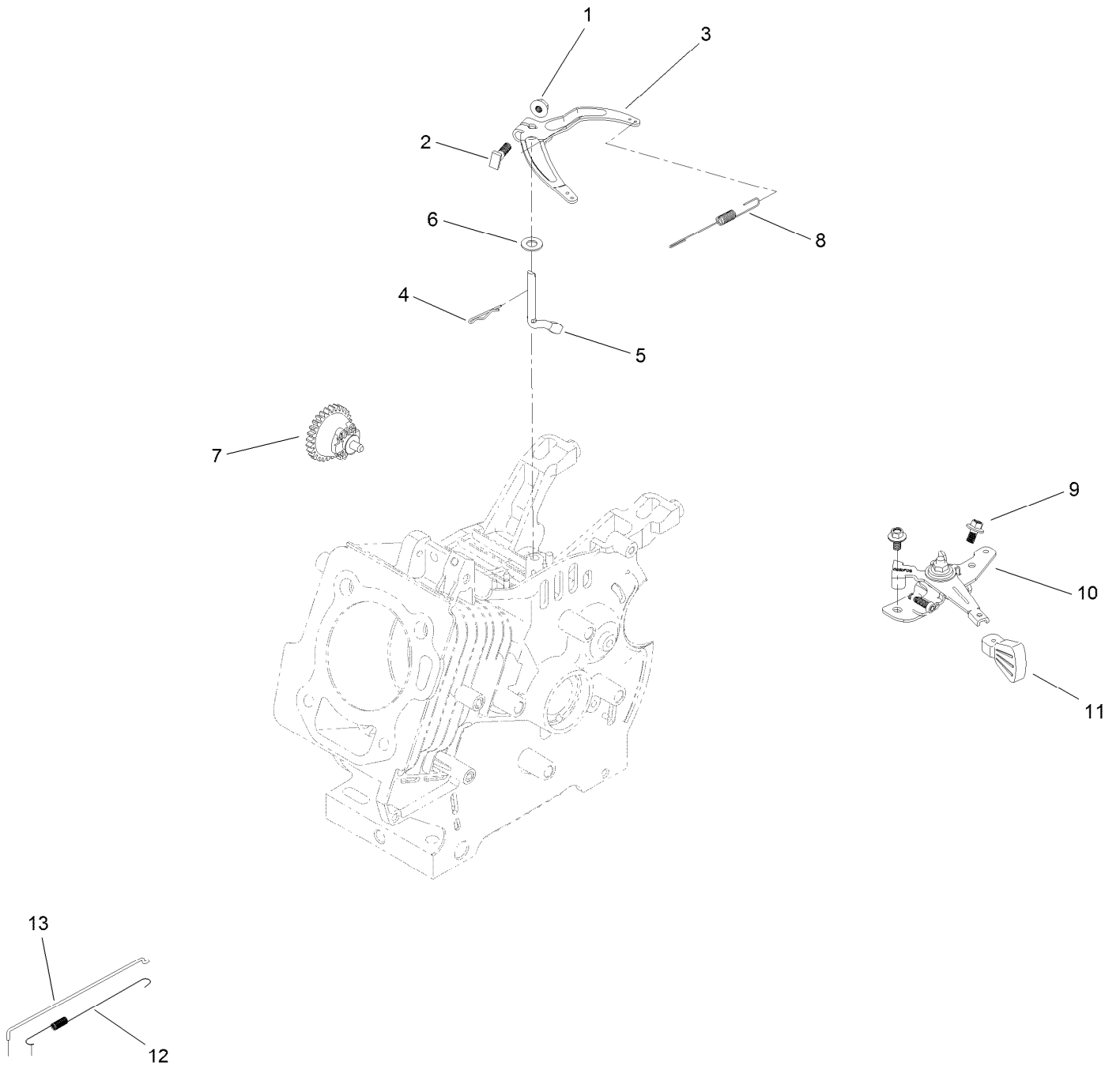

Governor Assembly (continued)

<i>Ref.</i>	<i>Part Number</i>	<i>Qty.</i>	<i>Description</i>	<i>Ref.</i>	<i>Part Number</i>	<i>Qty.</i>	<i>Description</i>
1	120-4236	1	Nut-Flange	8	127-9483	1	Spring-Governor
2	120-4238	1	Bolt-Arm, Governor	9	121-0116	2	Screw-HHF
3	127-9482	1	Arm-Governor	10	133-1555	1	Throttle Control ASM
4	120-4256	1	Pin-Hair	11	121-0269	1	Knob-Control, Throttle
5	133-9995	1	Shaft-Governor	12	133-1536	1	Spring-Return, Throttle
6	121-0498	1	Washer-Plain	13	133-1535	1	Rod-Governor
7	133-9994	1	Governor Gear ASM				

Piston and Head Assembly

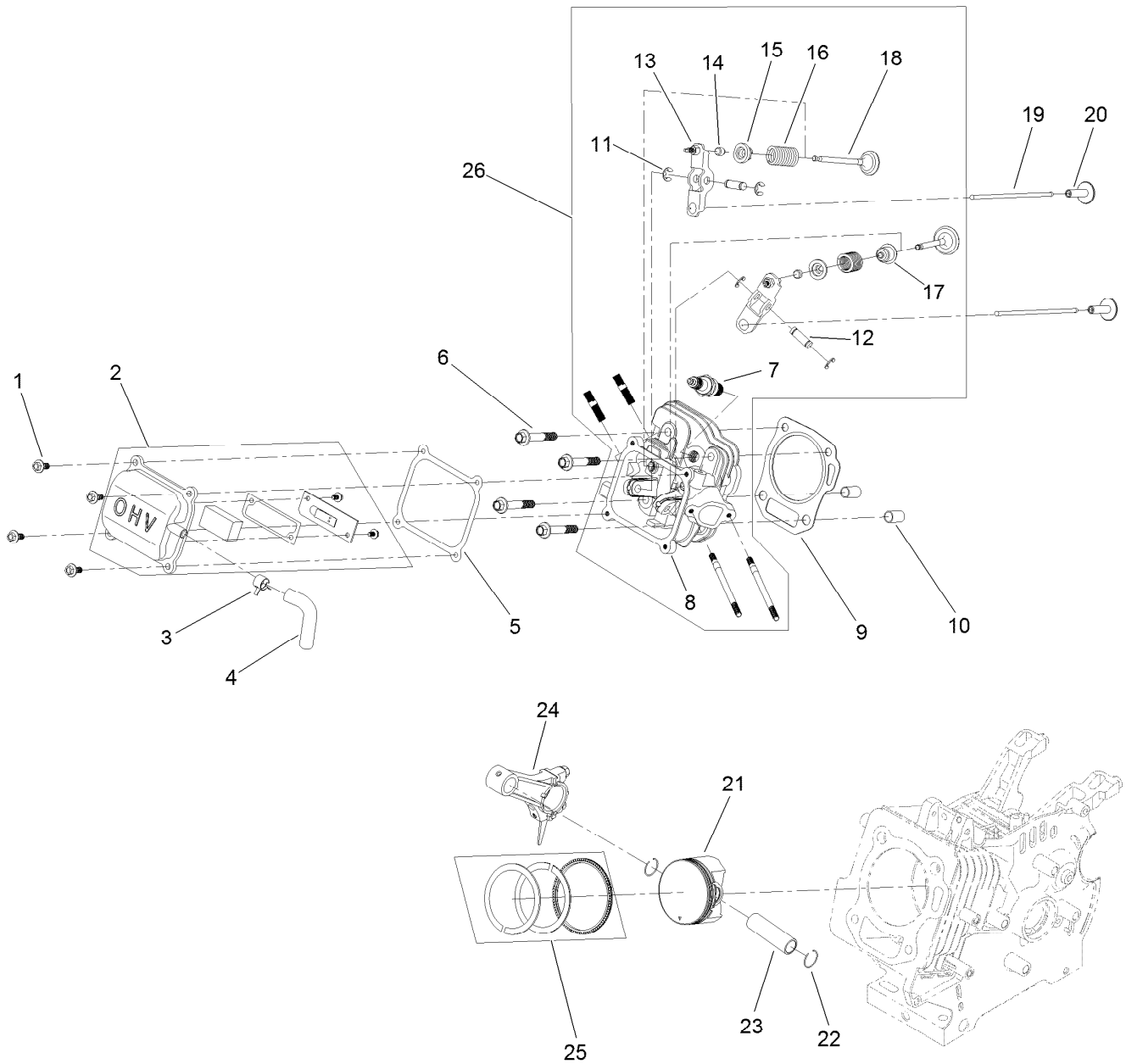

Piston and Head Assembly (continued)

<i>Ref.</i>	<i>Part Number</i>	<i>Qty.</i>	<i>Description</i>	<i>Ref.</i>	<i>Part Number</i>	<i>Qty.</i>	<i>Description</i>
1	120-4454	4	Screw-HHF	14	121-4116	2	Rotator-Valve
2	133-1500	1	Valve Cover ASM	15	121-4117	2	Retainer-Spring, Valve
3	133-1558	1	Clamp-Hose	16	127-9014	2	Spring-Valve
4	133-9990	1	Tube-Breather	17	121-4202	1	Seal-Stem, Valve
5	133-1507	1	Gasket-Cover, Valve	18	133-1515	1	Set-Valve
6	133-1508	4	Screw-Flange	19	133-1514	2	Rod-Push
7	81-3250	1	Spark Plug	20	127-9015	2	Tappet-Valve
8	133-1509	1	Head-Cylinder	21	133-1522	1	Piston
9	133-1510	1	Gasket-Head	22	121-0313	2	Clip-Pin, Piston
10	120-4200	2	Pin-Dowel	23	121-4128	1	Pin-Piston
11	133-1511	4	E-Clip	24	121-4123	1	Connecting Rod ASM
12	133-1512	2	Pin-Arm, Rocker	25	133-1521	1	Set-Ring, Piston
13	133-1513	2	Rocker Arm ASM	26	133-9867	1	Complete Head ASM

Blower Housing and Shrouds Assembly

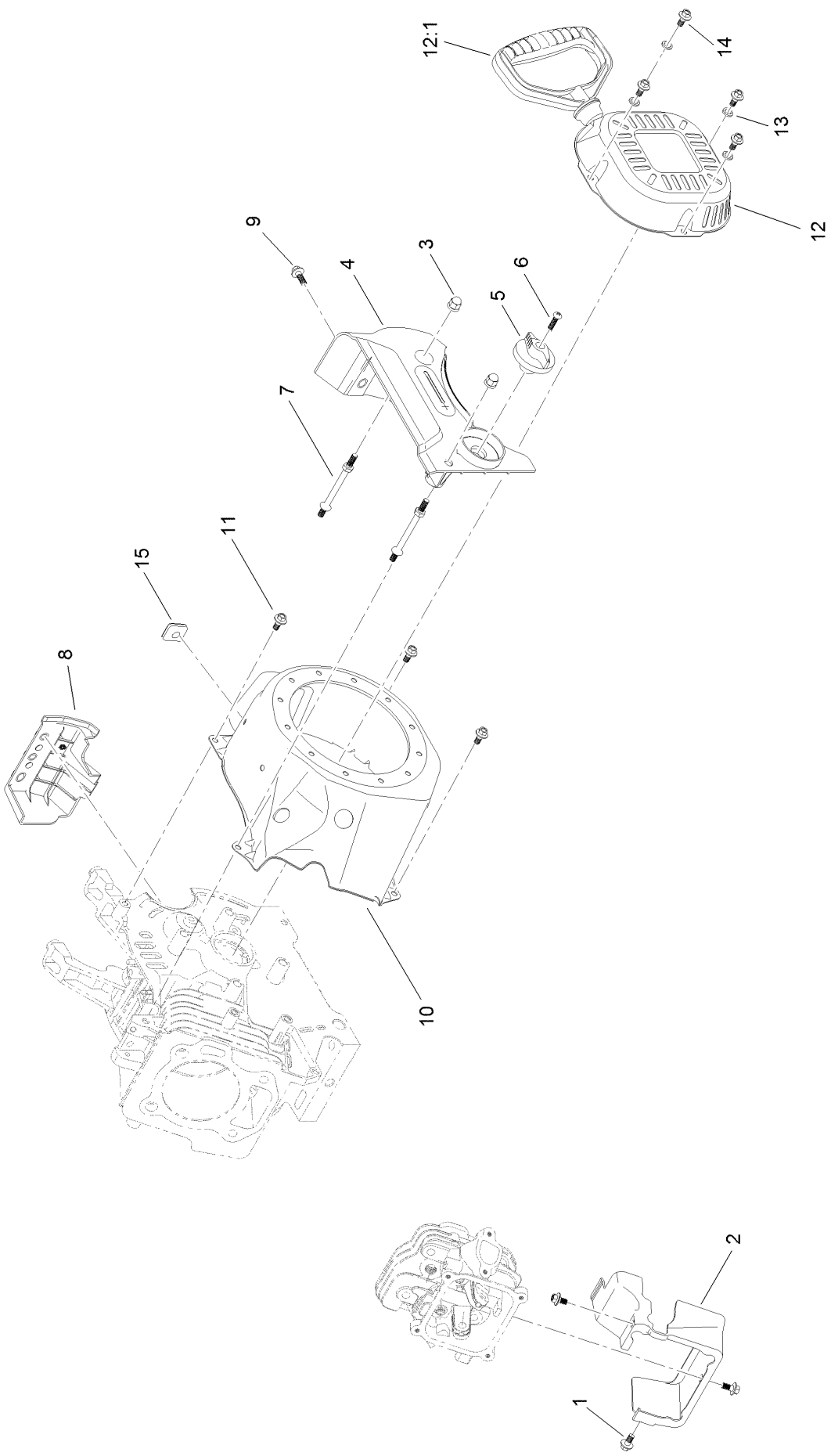

Blower Housing and Shrouds Assembly (continued)

<i>Ref.</i>	<i>Part Number</i>	<i>Qty.</i>	<i>Description</i>	<i>Ref.</i>	<i>Part Number</i>	<i>Qty.</i>	<i>Description</i>
1	121-0116	3	Screw-HHF	9	127-9123	1	Screw-HHF
2	133-1530	1	Shroud-Head	10	133-1528	1	Shroud-Flywheel
3	127-9383	2	Nut-Acorn	11	121-0294	3	Screw-HHF
4	133-1557	1	Panel-Control, Front	12	127-9487	1	Recoil ASM
5	121-0268	1	Knob-Valve, Fuel	12:1	121-0287	1	Handle-Recoil
6	121-0305	1	Screw-Bhp	13	127-9380	4	Washer-Plain
7	127-9110	2	Stud-Mount	14	127-9031	4	Screw-HHF
8	133-1543	1	Panel-Side, Engine	15	133-1548	1	Grommet-Rubber

Engine Decal Assembly

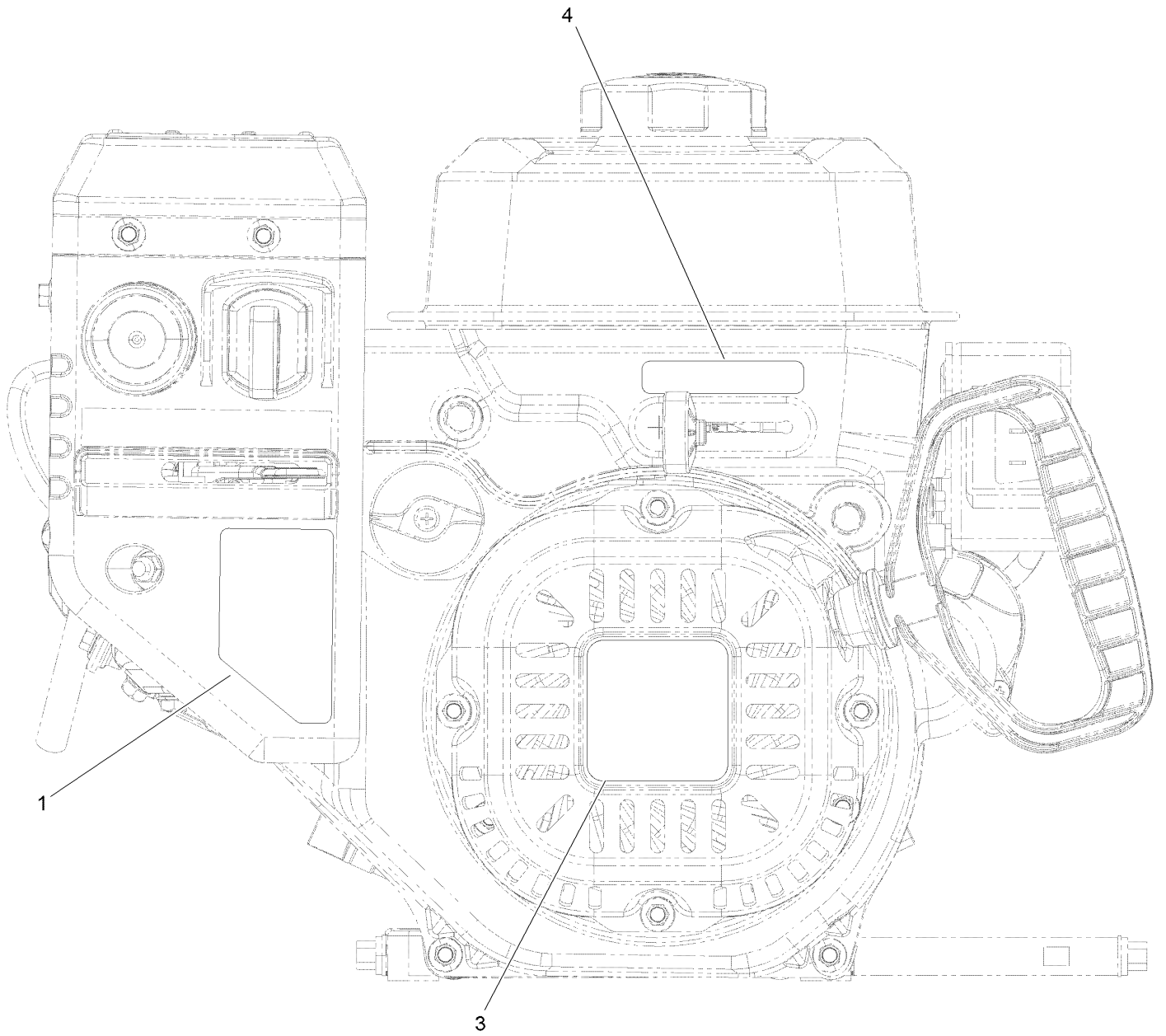

Engine Decal Assembly (continued)

<i>Ref.</i>	<i>Part Number</i>	<i>Qty.</i>	<i>Description</i>
1	120-9805	1	Decal-Control, Engine
3	131-5912	1	Decal-Recoil, G250
4	131-6487	1	Decal-Throttle

Chute Assembly

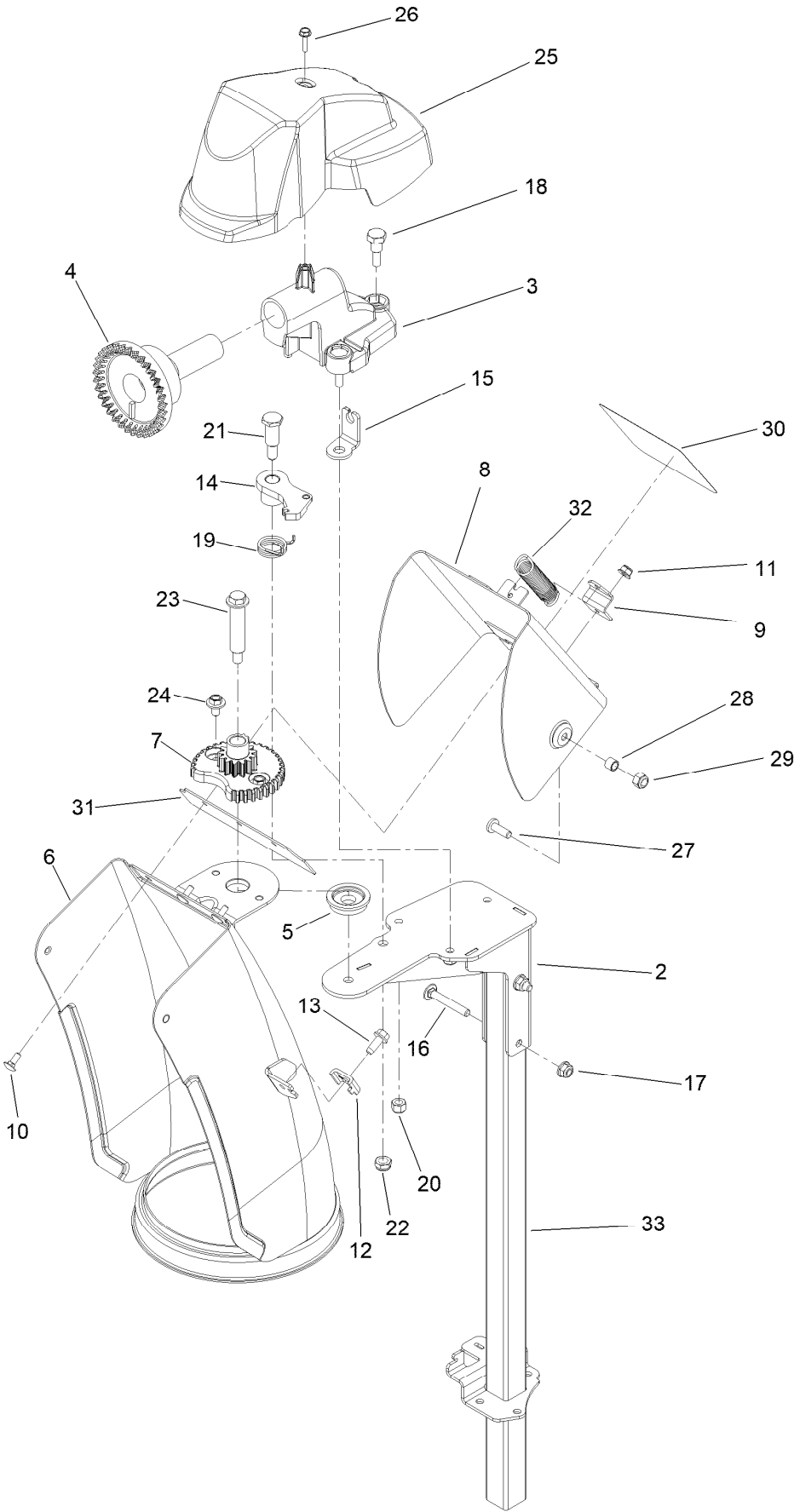

Chute Assembly (continued)

<i>Ref.</i>	<i>Part Number</i>	<i>Qty.</i>	<i>Description</i>	<i>Ref.</i>	<i>Part Number</i>	<i>Qty.</i>	<i>Description</i>
2	144-1640-03	1	Support-Chute Weld ASM, Upper	18	136-7197	3	Screw-Shoulder
3	138-3606	1	Mount-Gear, Face	19	108-7315	1	Spring-Torsion
4	106-4471	1	Gear-Face	20	137-3088	3	Nut-Hex
5	106-4422	1	Spacer-Chute	21	137-3103	1	Screw-Shoulder, HH
6	138-3611-01	1	Chute	22	137-3089	3	Nut-Hex
7	106-4472	1	Gear-Chute	23	136-7199	1	Bolt-Shoulder
8	138-3615-01	1	Deflector	24	32144-4	2	Screw-HWH
9	138-3612-01	1	Bracket-Spring	25	138-3627	1	Cover-Chute, Gear
10	135-1929	3	Bolt-CARR	26	98-1375	1	Screw-HWH
11	138-0719	3	Nut-HF	27	138-0689	1	Screw-PH
12	136-7191	1	Clamp-Cable	28	138-3678	1	Spacer
13	137-3043	1	Screw-HWH	29	137-3094	1	Nut-Hex
14	106-4476	1	Latch-Chute	30	137-6198	1	Decal-Danger
15	138-3607	1	Anchor-Cable	31	138-3671	1	Gasket-Deflector
16	120-9698	2	Bolt-CARR	32	138-8493	1	Spring-Chute, Upper
17	119-4040	2	Nut-HF, NI	33	144-1642-03	1	Chute Support ASM [black]

Lever Chute Control Assembly

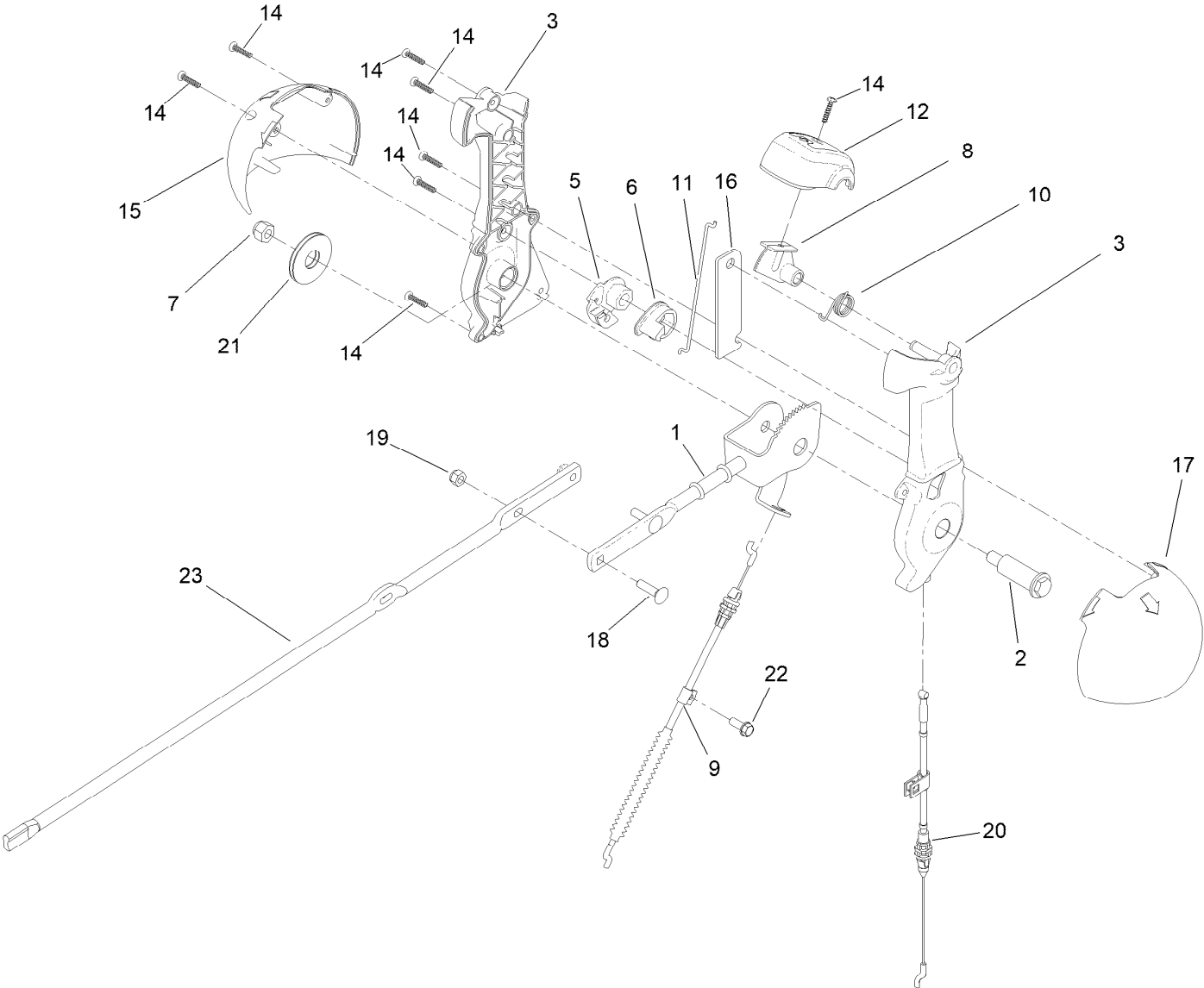

Lever Chute Control Assembly (continued)

<i>Ref.</i>	<i>Part Number</i>	<i>Qty.</i>	<i>Description</i>	<i>Ref.</i>	<i>Part Number</i>	<i>Qty.</i>	<i>Description</i>
1	138-0662	1	Rod-Control, Chute	14	94-4496	8	Screw-PPH
2	138-0659	1	Screw-Shoulder, HWH	15	136-6677	1	Globe-Quickstick, RH
3	139-1552	1	Chute Control Lever ASM	16	136-6632	1	Plate-Stiffner
5	105-9988	1	Lever-Cable, Deflector	17	136-6678	1	Globe-Quickstick, LH
6	106-7310	1	Pawl-Latch	18	137-3056	3	Bolt-CARR
7	137-3087	1	Nut-Hex	19	137-3094	3	Nut-Hex
8	137-6238	1	Trigger-Latch	20	144-1237	1	Cable-Rotation, Chute
9	138-3672	1	Cable-Control, Deflector	21	138-0744	1	Washer-Friction, Composite
10	105-9982	1	Spring-Torsion	22	32144-85	1	Screw-HWH Thd Form
11	138-0688	1	Link-Latch	23	138-3635	1	Rod-Chute
12	137-6239	1	Cap-Lever				

Handle Assembly

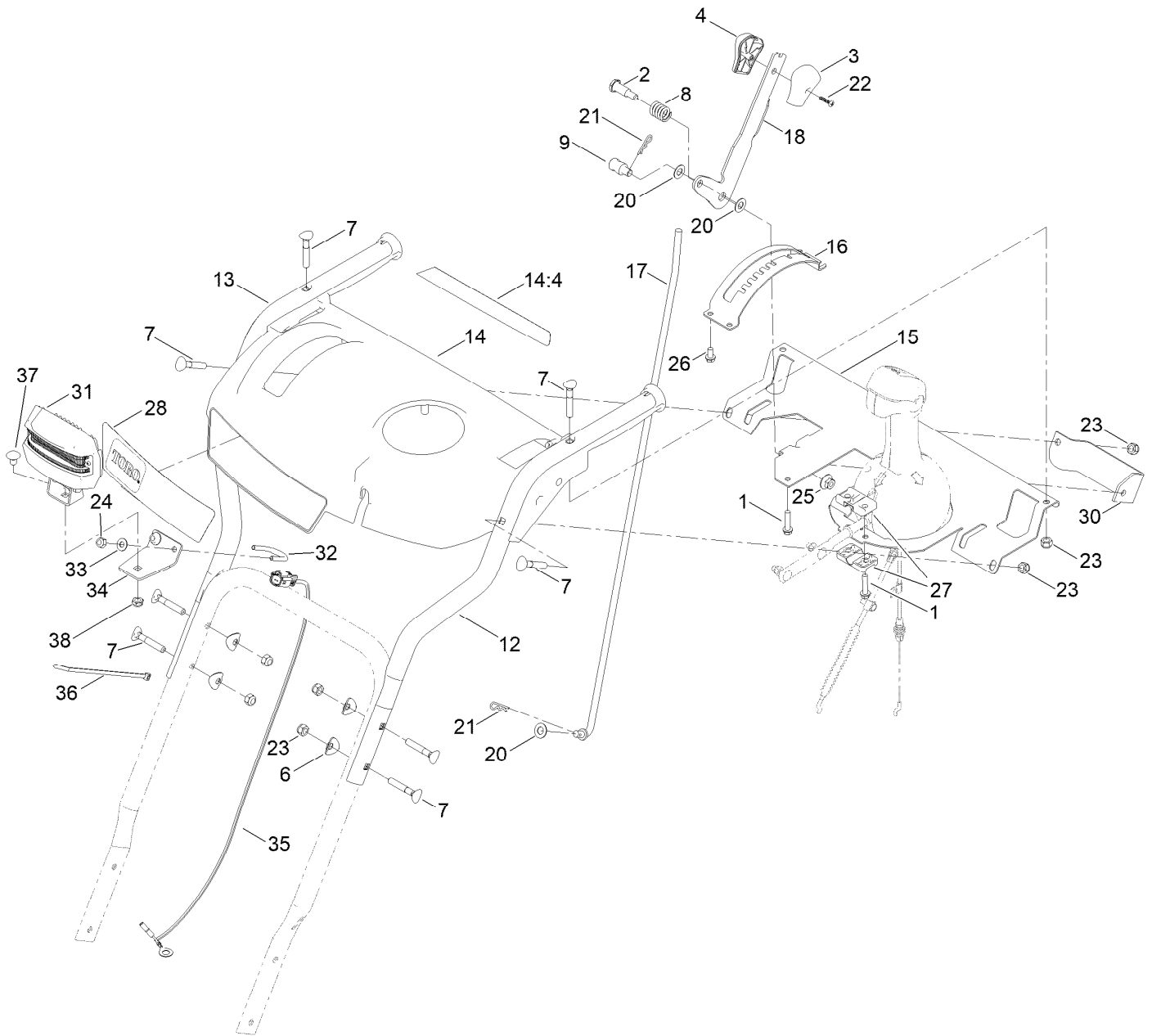

Handle Assembly (continued)

<i>Ref.</i>	<i>Part Number</i>	<i>Qty.</i>	<i>Description</i>	<i>Ref.</i>	<i>Part Number</i>	<i>Qty.</i>	<i>Description</i>
1	137-3101	3	Screw-Plastic, HWH	21	137-3083	2	Pin-Hair
2	137-3103	1	Screw-Shoulder, HH	22	94-4496	1	Screw-PPH
3	105-9999	1	Knob-Shift, LH	23	137-3093	8	Nut-Hex
4	106-4423	1	Knob-Shift, RH	24	137-3094	2	Nut-Hex
6	137-3009	4	Washer-Cup	25	137-3038	1	Nut-HF
7	137-3107	8	Screw-Handle	26	46-8093	4	Screw-Plastite
8	136-7121	1	Spring-Compression	27	105-9987	2	Support-Rod
9	136-7193	1	Trunnion-Rod	28	139-3693	1	Decal-Console
12	120-7173-03	1	Handle-Upper, LH	30	120-2301-03	1	Plate-Support, Shift
13	120-7174-03	1	Handle-Upper, RH	31	138-0670	1	LED Light ASM
14	138-8487	1	Control Panel ASM	32	136-7120	1	Clamp-Light
14:4	121-1240	1	Decal-Safety	33	139-1699	2	Washer-Flat
15	138-3676-03	1	Support-Panel, Control	34	127-5961-03	1	Bracket-Light
16	120-9258-03	1	Mount-Selector, Speed	35	138-3658	1	Harness-Wire
17	136-7163	1	Rod-Selector, Gear	36	614249	1	Tie-Cable
18	121-1242-03	1	Selector-Speed	37	3230-19	1	Bolt-CARR
20	131-8667	3	Washer-Thrust	38	137-3089	1	Nut-Hex

Control Assembly

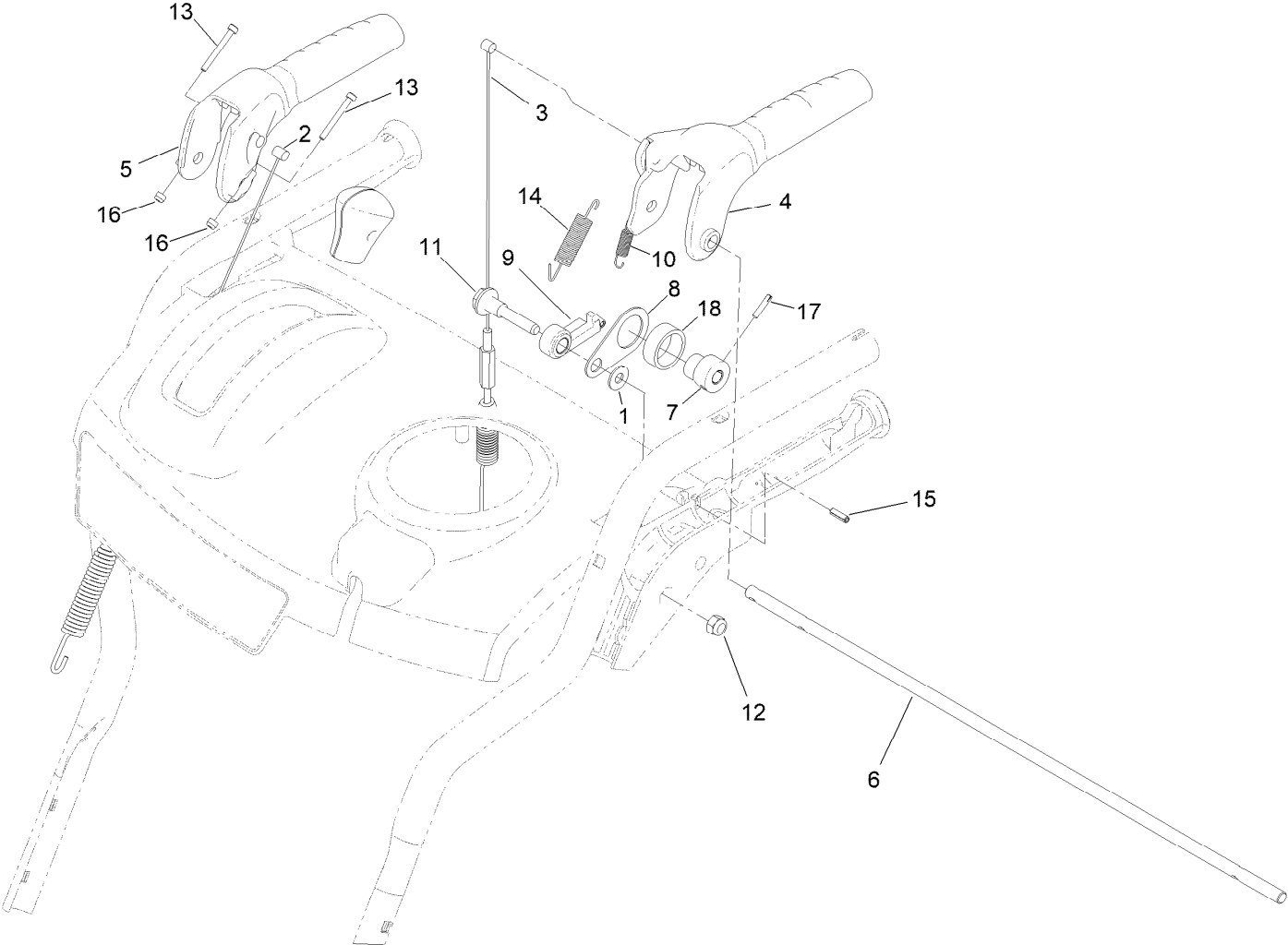

Control Assembly (continued)

<i>Ref.</i>	<i>Part Number</i>	<i>Qty.</i>	<i>Description</i>	<i>Ref.</i>	<i>Part Number</i>	<i>Qty.</i>	<i>Description</i>
1	98-3499	1	Washer-Flat	10	136-7161	1	Spring-Lockout, Handle
2	161-0972	1	Cable-Auger	11	136-7194	1	Screw-Shoulder
3	161-0975	1	Cable-Traction	12	137-3093	1	Nut-Hex
4	121-1200	1	Handle-Control, Traction	13	145-0660	2	Screw-HSH,Spl
5	121-1201	1	Handle-Control, Auger	14	136-7162	1	Spring-Return, Lever
6	136-7125	1	Rod-Lockout	15	32121-2	1	Pin-Roll, Slotted
7	121-1203	1	Cam-Lockout	16	140-3749	2	Nut-Lock Rohs
8	136-7160	1	Link-Lockout	17	145-0659	1	Pin-Quarter Groove
9	121-1205	1	Latch-Lockout	18	145-0667	1	Spacer-Plastic

Attachments and Accessories

For 37799 Power Max 826 OAE Snowthrower

Product Name	Model/Part
Weight Kit	107-3815
Snow Cab Kit.....	127-5960
Engine Maintenance Kit.....	138-0702
Non-Marking Skid Kit.....	38211
Heavy-Duty Skid Kit.....	38212
Drift Breaker Kit	38213
Toro Snow Oil 0W30 Synthetic 20-Ounce Bottle	38913
Toro 2-Stage Cover.....	490-7466
Plain 2-Stage Cover.....	490-7467

Notes:



Count on it.