



22in Recycler[®] Max Lawn Mower

Tondeuse Recycler[®] Max de 56 cm (22 po)

Quick Start Guide/Guide de Démarrage Rapide



**Register your product.
Enregistrer votre produit.**

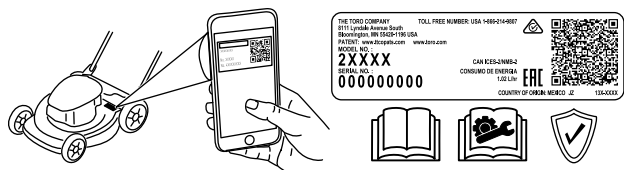

⚠ WARNING

CALIFORNIA

Proposition 65 Warning

The engine exhaust from this product contains chemicals known to the State of California to cause cancer, birth defects, or other reproductive harm.

Use of this product may cause exposure to chemicals known to the State of California to cause cancer, birth defects, or other reproductive harm.

For the *Operator's Manual*, the complete warranty details, or to register your product, use the QR code, or visit www.Toro.com.
Pour vous procurer le Manuel de l'utilisateur, des détails complets sur la garantie ou pour enregistrer votre produit, utilisez le code QR ou rendez-vous sur www.Toro.com.

| | | | | |
|---|---|---|---|--|
| Safety alert; warning Alerte de sécurité ; avertissement | Read the Operator's Manual. Lisez le Manuel de l'utilisateur. | Keep hands away. N'approchez pas les mains. | Pick up any debris before mowing. Ramassez les débris éventuellement présents avant de tondre. | Wear hearing protection. Portez des protecteurs d'oreilles. |
| Look behind you when backing up. Regardez derrière la machine avant de faire marche arrière. | Fire hazard Risque d'incendie | Toxic gas inhalation hazard Risque d'intoxication par inhalation de gaz | Thrown object hazard Risque de projections d'objet | Hot surface/burn hazard Surface brûlante/risque de brûlure |
| Keep bystanders a safe distance away from the machine. Tenez tout le monde à une distance suffisante de la machine. | Cutting/dismemberment hazard of hand or foot, mower blade Risque de coupure/mutilation des mains ou des pieds, la lame de la tondeuse | Do not operate the machine unless you are trained. N'utilisez pas la machine à moins d'avoir les compétences nécessaires. | Shut off the engine before leaving the operating position. Coupez le moteur avant de quitter la position d'utilisation. | Contains lead; do not discard. Contient du plomb – ne mettez pas au rebut |
| Stay away from moving parts; keep all guards and shields in place. Ne vous approchez pas des pièces mobiles ; laissez toutes les protections et tous les capots en place. | Disconnect the spark-plug wire and read the instructions before servicing or performing maintenance. Débranchez le fil de la bougie et lisez les instructions avant de procéder à l'entretien ou à des révisions. | Do not operate the machine up and down slopes; operate the machine side to side on slopes. Ne travaillez pas dans le sens de la pente, mais transversalement. | Do not operate the machine with the deflector up or removed; keep the deflector in place. N'utilisez pas la machine avec le déflecteur relevé ou sans le déflecteur ; laissez-le toujours en place. | Do not operate the machine without the rear-discharge plug or bag in place; do not operate the machine without the side-discharge cover or deflector in place. N'utilisez pas la machine sans l'obturateur de l'éjecteur arrière ou le bac à herbe ; n'utilisez pas la machine sans le couvercle d'éjection latérale ou le déflecteur. |

You may also mail us a written request for a printed copy of the product warranty.
Vous pouvez également nous envoyer une demande écrite pour obtenir une copie imprimée de la garantie du produit.



1

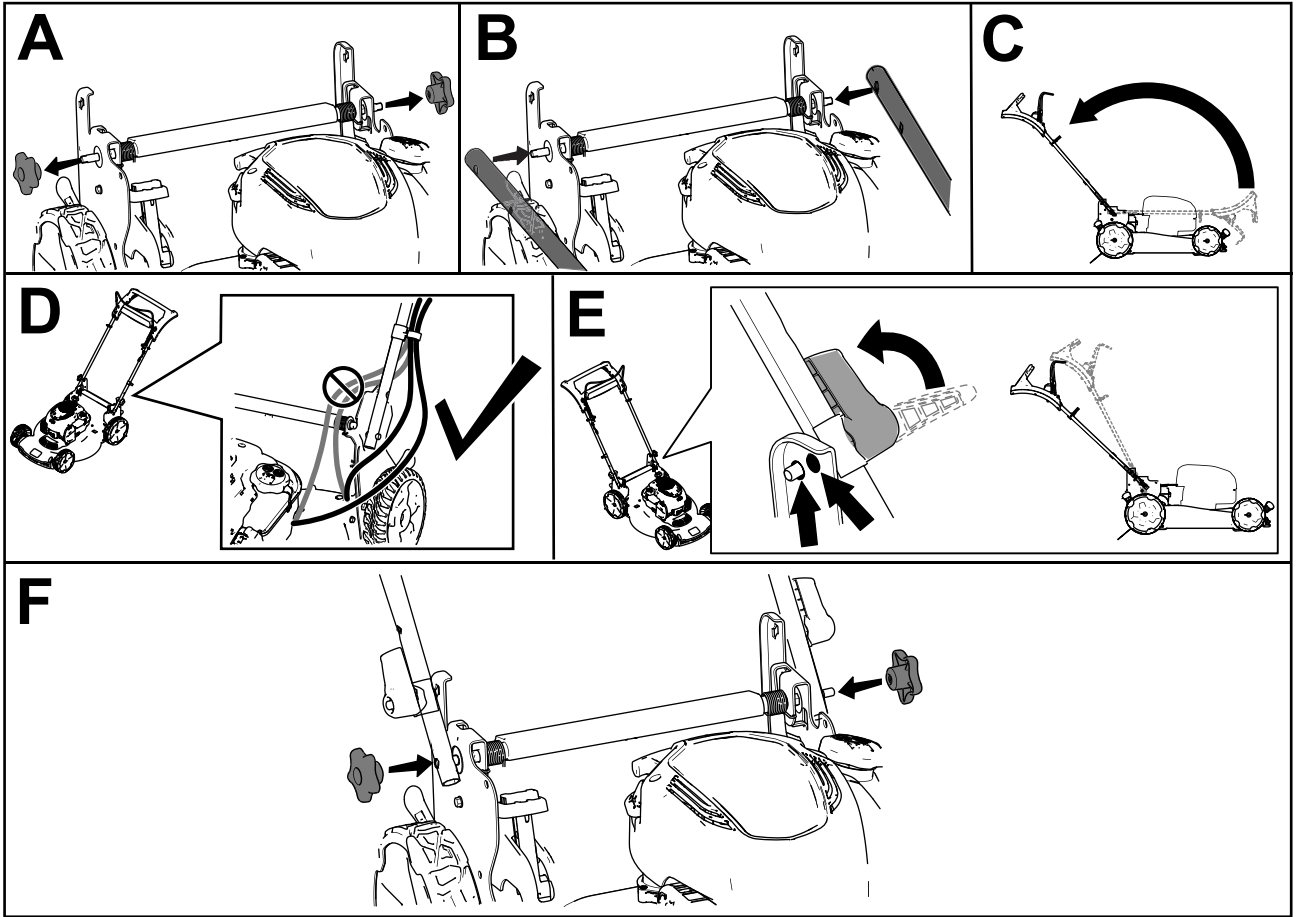

g334364

2

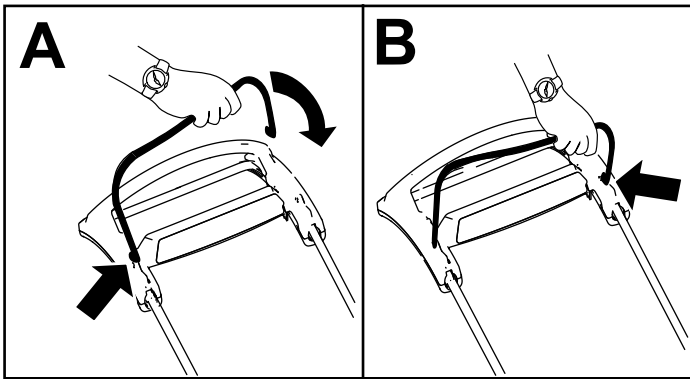

g344378

3

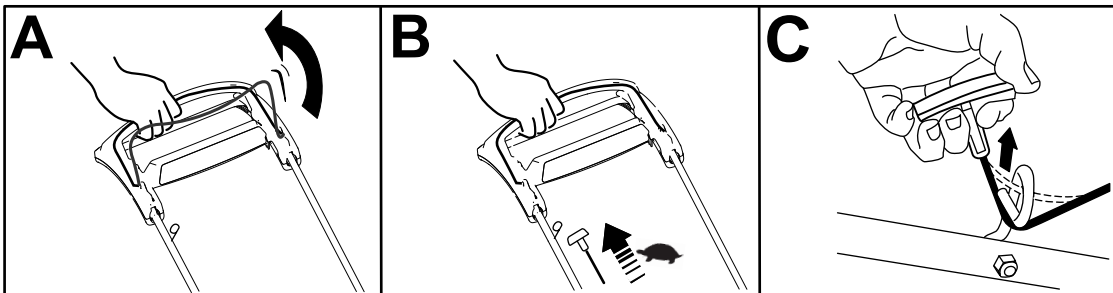

g334093

4

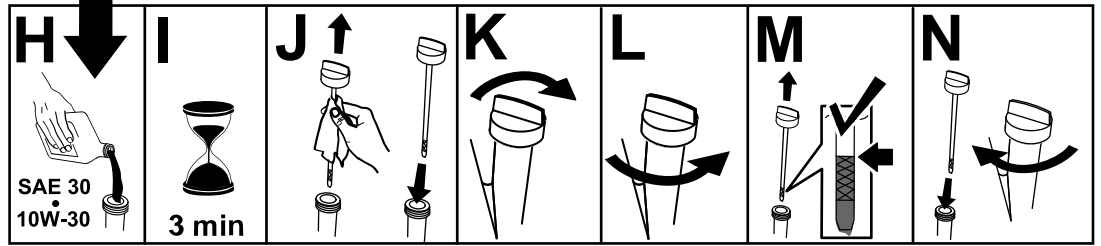
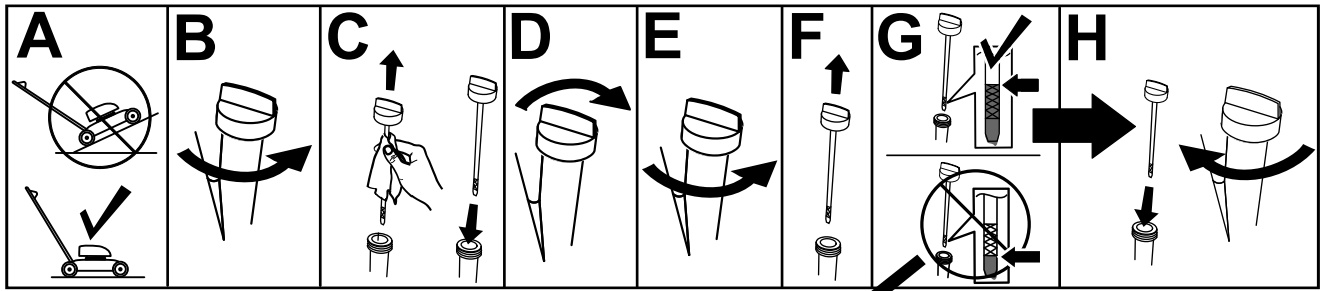

g231765

5

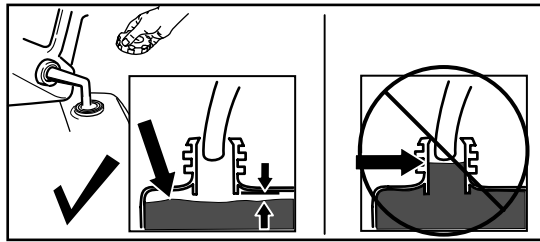

g231763

6

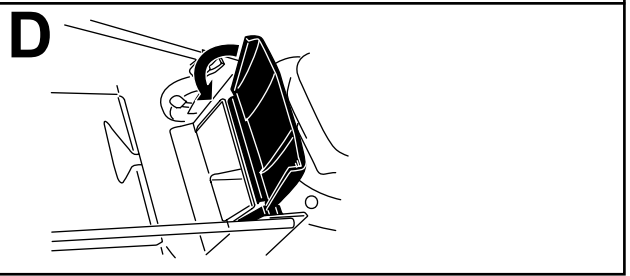
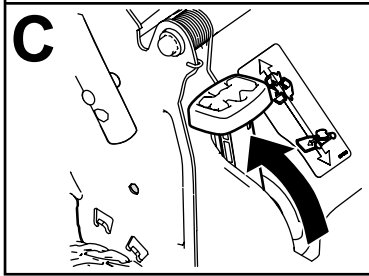
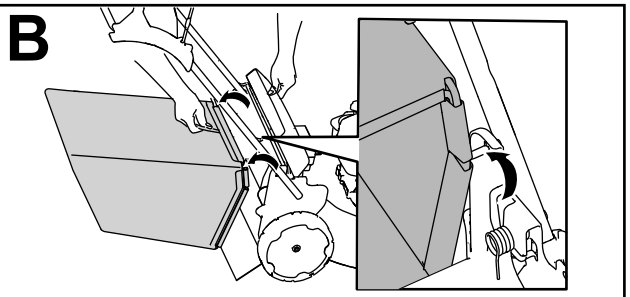
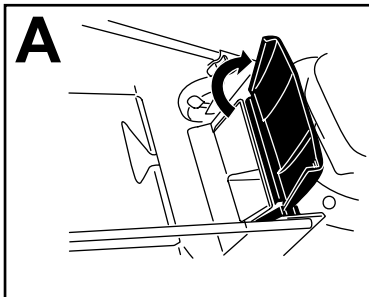
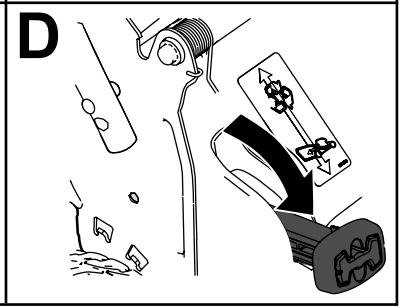
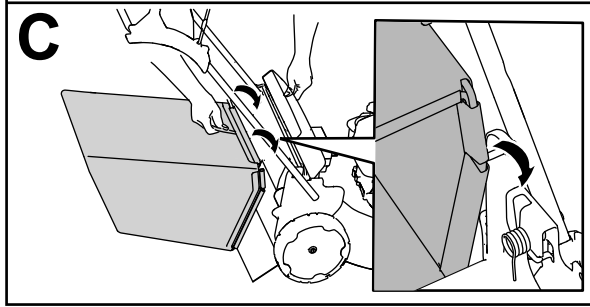
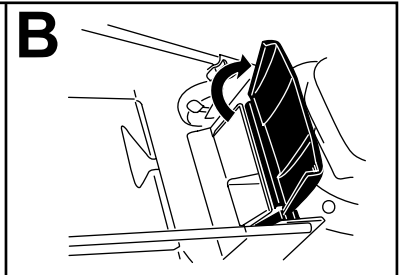
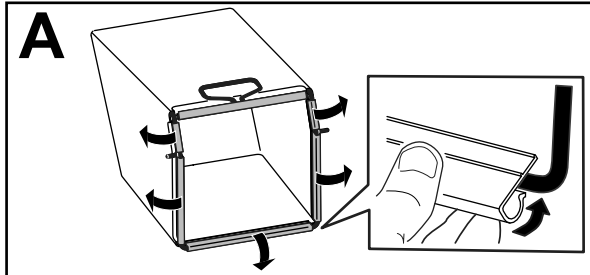
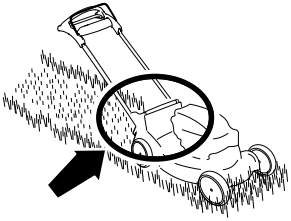
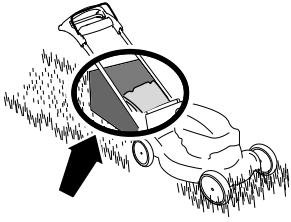

g451617

7

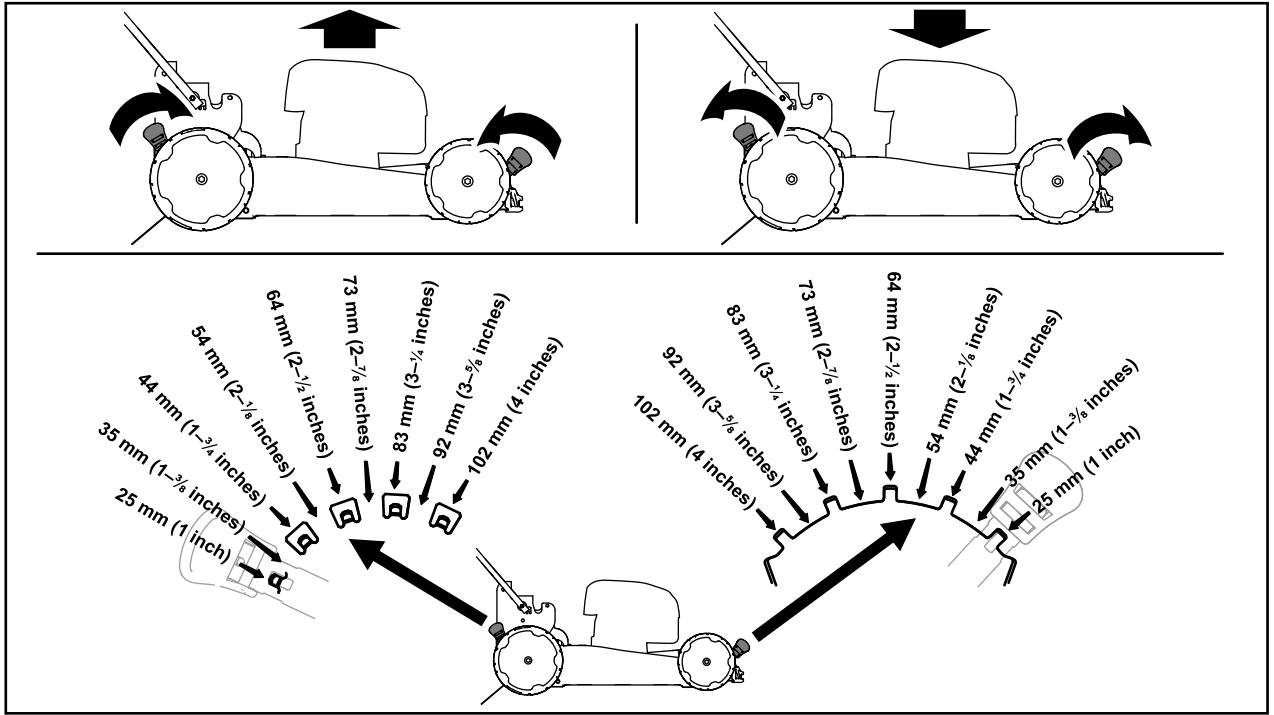

g451640

8

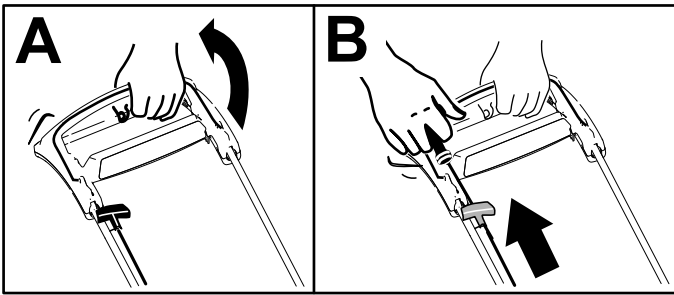

g334135

9

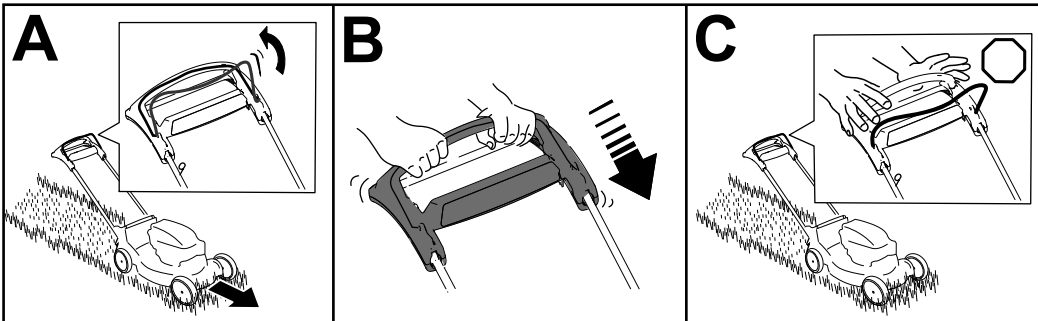

g451658

10

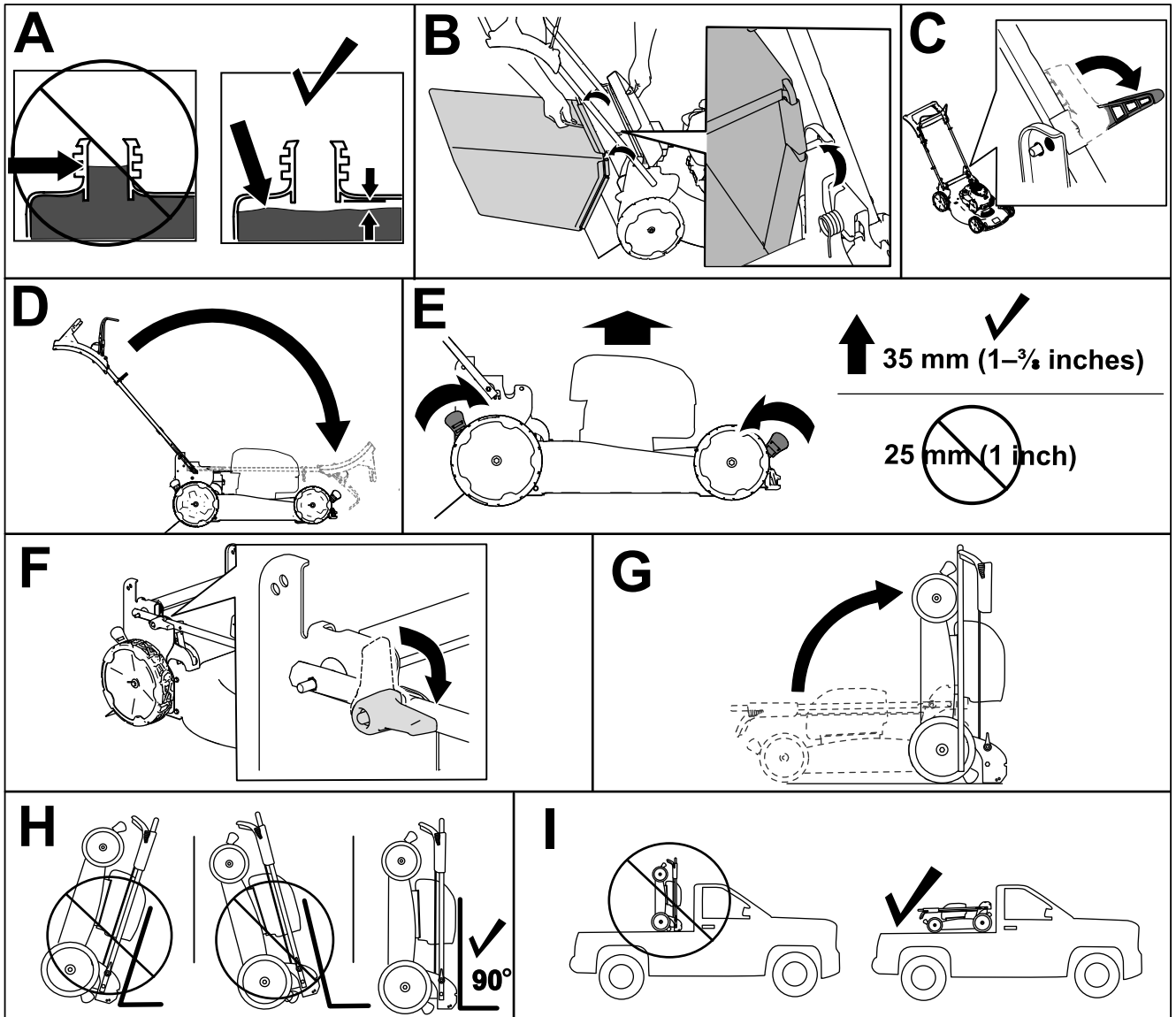

g451676

