



Count on it.

Parts Catalog

**72in Rear Discharge Rotary
Mower**

**Groundsmaster® 3200 or 3300 Series
Traction Unit**

Model No. 31975—Serial No. 407200000 and Up



Ordering Replacement Parts

To order replacement parts, please supply the part number, the quantity, and the description of each part desired.

Understanding Reference Numbers

Each identified part in an illustration has a reference number. The reference number for a part also appears in the parts list, along with other information about the part.

This catalog uses two special reference number formats, one to indicate parts in a service assembly and another to indicate the quantity of a given part in an illustration.

Service Assembly Reference Numbers

Parts in service assemblies have reference numbers in the form a:b. The a represents the reference number of the entire service assembly and the b represents a sequential number unique to each part within the service assembly.

For example, a wheel assembly might be identified by reference number 6, the tire by 6:1, the valve by 6:2, and the wheel by 6:3. When you order the assembly identified by reference number 6, you receive all parts identified by reference numbers 6:1, 6:2, and 6:3. However, you may also order any part individually. Reference numbers of this type appear in illustration and in parts lists.

Reference Numbers Indicating Quantity

In an illustration, if a reference number indicates more than one part, the reference number has the form nX y. The n represents the quantity of the part, the X is the multiplication symbol, and the y represents the reference number.

For example, in an illustration, the reference number 2X 37 means that two of the parts identified by reference number 37 are indicated.

Contents

Deck Assembly	4
Decal Deck Assembly No. 139-0894SP	6
Spindle Assembly No. 137-9780	8
Gearbox Assembly	10
Gearbox Assembly No. 145-5990	12
Tensioner Assembly No. 140-9027	14
Belt Cover, Caster Arm and Wheel Assembly	16
Wheel Assembly No. 137-5529	18
Latch Assembly No. 139-0888	20

Deck Assembly

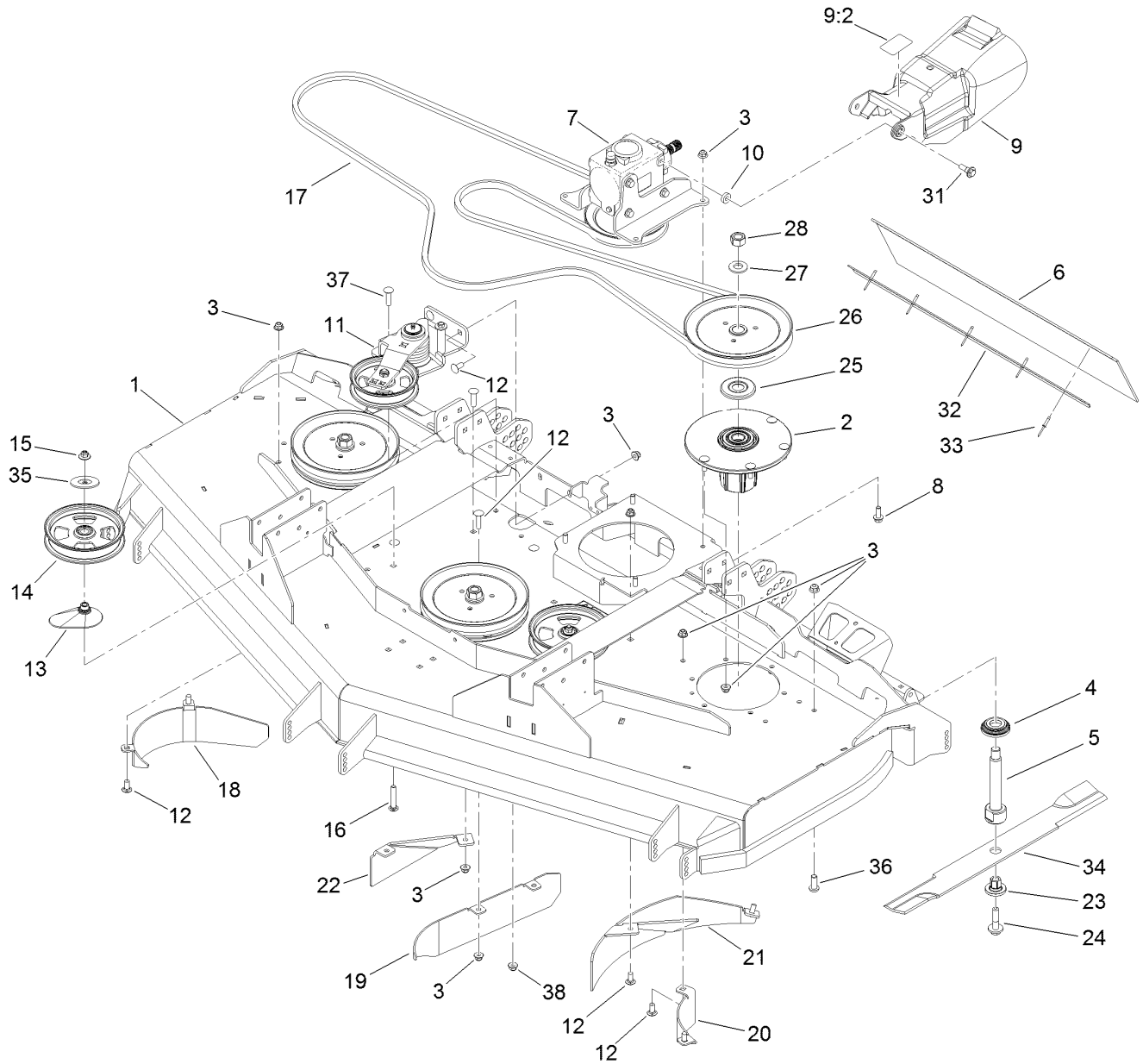

Deck Assembly (continued)

<i>Ref.</i>	<i>Part Number</i>	<i>Qty.</i>	<i>Description</i>	<i>Ref.</i>	<i>Part Number</i>	<i>Qty.</i>	<i>Description</i>
1	139-0894SP	1	Deck W/Decals	18	137-2541-0P	1	Baffle-Inner, LH
2	137-9780	3	Spindle ASM	19	140-9043-0P	1	Baffle-Inner, Center
3	104-8301	40	Nut-HF, NI	20	137-2543-0P	1	Baffle-Inner, RH
4	137-9784	3	Guard-Bottom	21	139-6312-0P	1	Baffle
5	138-6045	3	Shaft-Spindle	22	140-9045-0P	1	Baffle-Kicker, Center
6	140-3054	1	Flap-Rubber, Middle	23	137-9787	3	Bushing-Hex
7		1	Gearbox ASM ●	24	109-9220	3	Screw-Sems
8	3231-22	4	Screw-CARR	25	103-1330	3	Guard-Bearing, Top
9	139-6301	1	PTO Guard W/Decals	26	138-6060	3	Sheave-Drive, Blade
9:2	139-6303	1	Decal-Danger, Entanglement	27	103-2802	3	Washer
10	5-0652	2	Spacer	28	116-7306	3	Nut-Hex
11	140-9027	1	Tensioner ASM	31	109-9840	2	Screw-Shoulder, HHF
12	3231-27	9	Screw-CARR	32	140-3053-0P	1	Bracket-Flap, Middle
13	109-2872	2	Spacer-Pulley	33	103-0138	5	Rivet-Pop
14	136-5404	2	Pulley-Idler, Flat	34	140-4851	3	Blade-Low Flow, 24.50
15	109-6658	2	Nut-Flange, NI	35	126-8043	2	Shield-Dust
16	3231-40	2	Bolt-CARR	36	3274-80	7	Screw-HH
17	140-3065	1	Belt-B Section	37	3231-28	5	Screw-CARR
				38	32128-21	3	Nut-HF Lock

● Not serviced separately

Decal Deck Assembly No. 139-0894SP

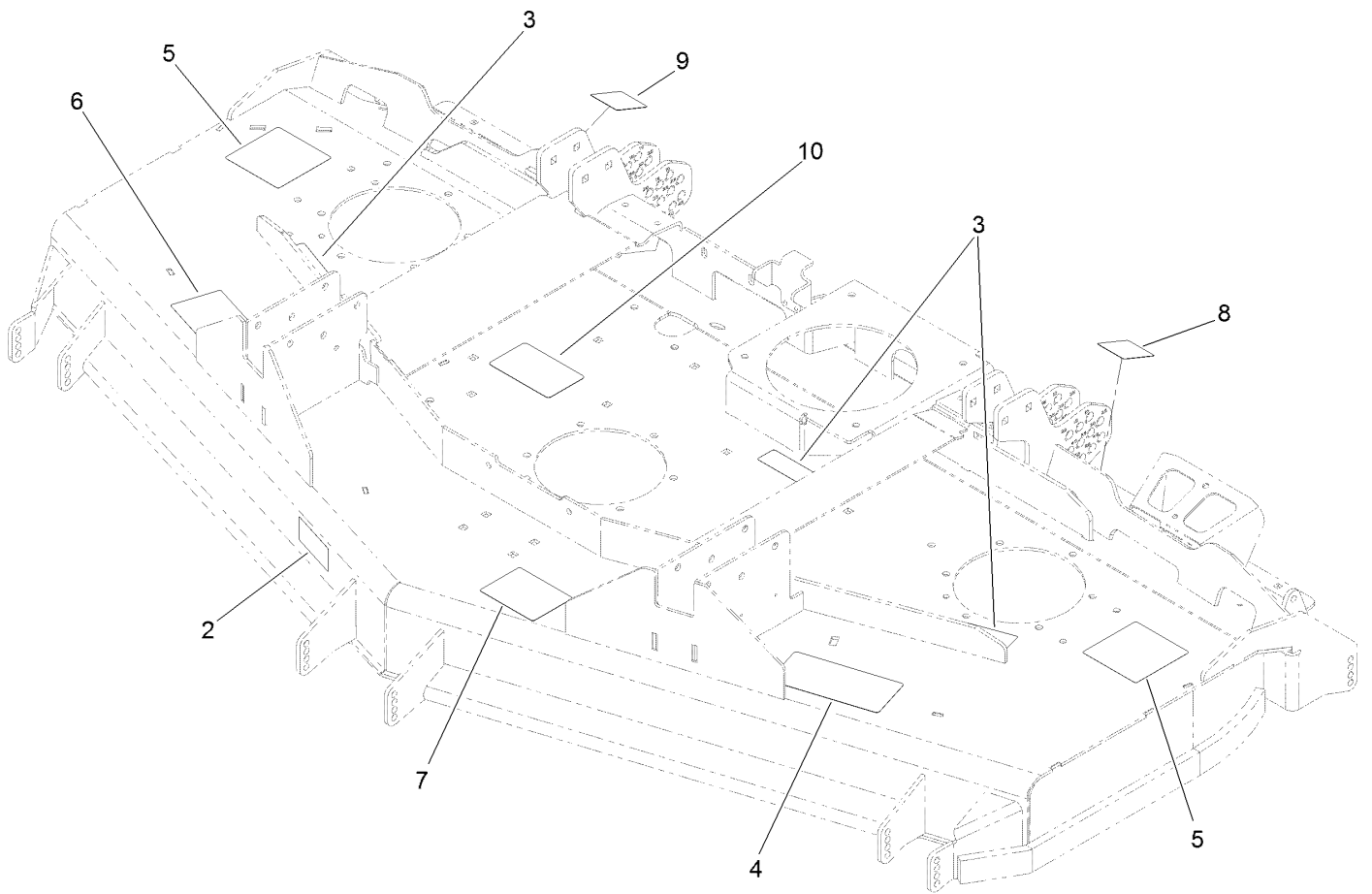

Decal Deck Assembly No. 139-0894SP (continued)

<i>Ref.</i>	<i>Part Number</i>	<i>Qty.</i>	<i>Description</i>	<i>Ref.</i>	<i>Part Number</i>	<i>Qty.</i>	<i>Description</i>
2	116-8283	1	Decal-Torque, Bolt	7	127-0326	1	Decal-Scalp, Anti
3	117-4979	3	Decal-Warning	8	137-5945	1	Decal-H0C, LH
4	137-5949	1	Decal-HOC	9	137-5946	1	Decal-HOC, RH
5	120-6604	2	Decal-Danger	10	138-7359	1	Decal-Routing, Belt
6	140-3146	1	Decal-183 CM				

Spindle Assembly No. 137-9780



Spindle Assembly No. 137-9780 (continued)

<i>Ref.</i>	<i>Part Number</i>	<i>Qty.</i>	<i>Description</i>
2	116-0720	2	Bearing-Ball
3	138-6042	1	Spacer-Bearing

Gearbox Assembly

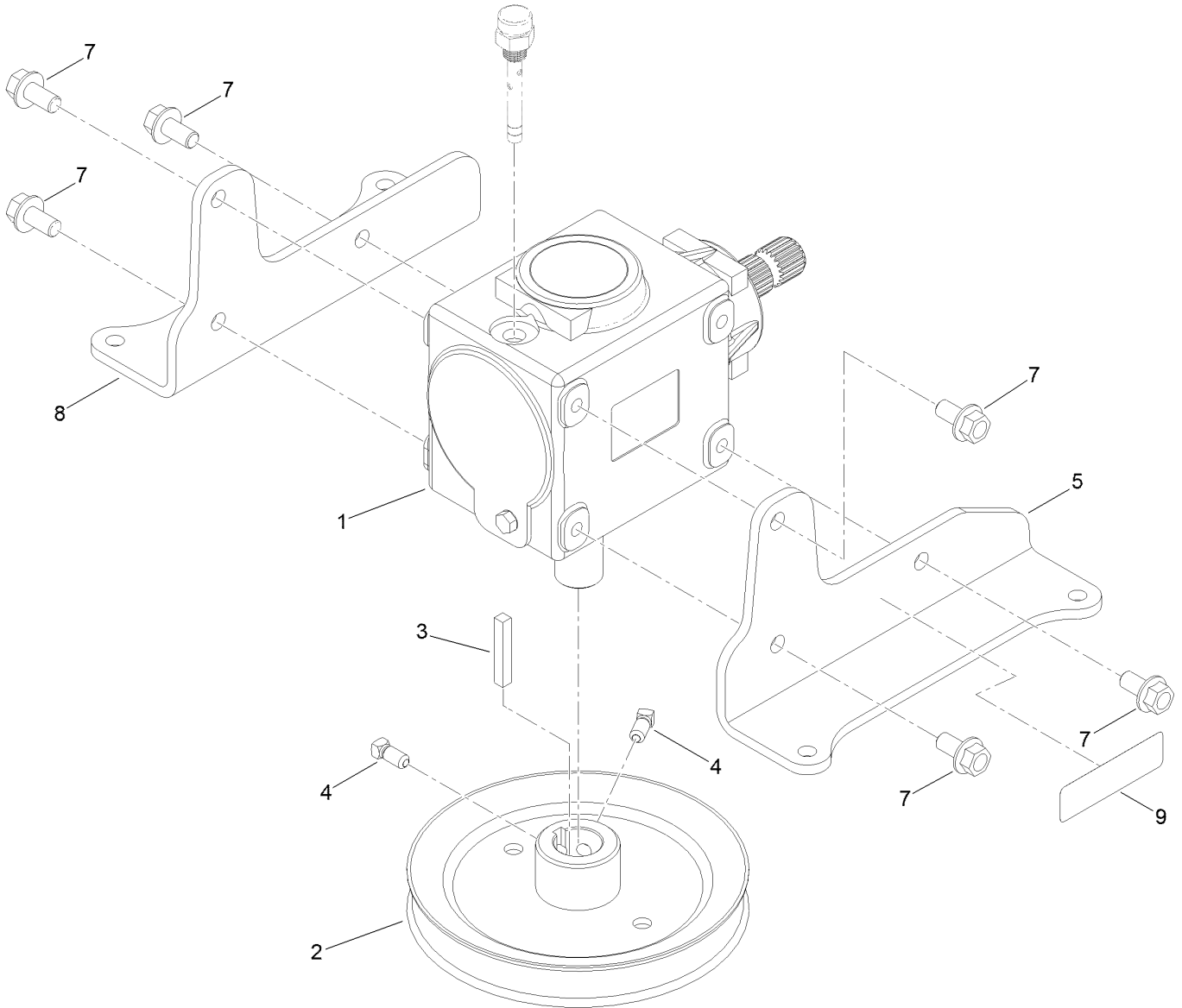

Gearbox Assembly (continued)

<i>Ref.</i>	<i>Part Number</i>	<i>Qty.</i>	<i>Description</i>	<i>Ref.</i>	<i>Part Number</i>	<i>Qty.</i>	<i>Description</i>
1	145-5990	1	Gearbox	5	144-0494-03	1	Bracket-Gearbox, LH
2	140-9038	1	Pulley	7	139-6300	6	Screw-Hfl
3	94-2425	1	Key-Square	8	144-0495-03	1	Bracket-Gearbox, RH
4	1-803022	2	Screw-Set	9	93-6697	1	Decal-Lube

Gearbox Assembly No. 145-5990

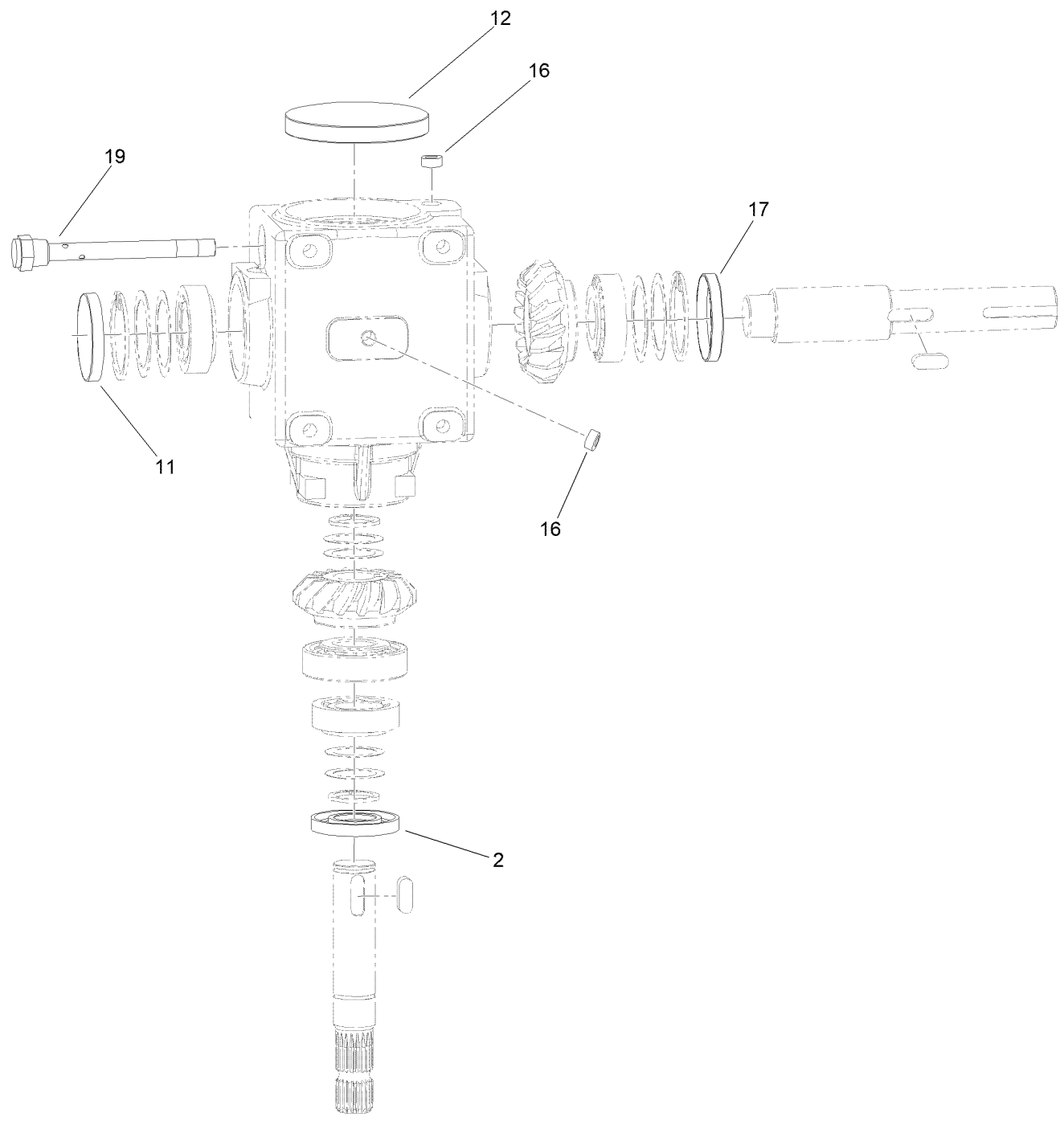

Gearbox Assembly No. 145-5990 (continued)

<i>Ref.</i>	<i>Part Number</i>	<i>Qty.</i>	<i>Description</i>	<i>Ref.</i>	<i>Part Number</i>	<i>Qty.</i>	<i>Description</i>
2	140-7133	1	Seal-Oil	16	140-7132	3	Plug
11	140-7129	1	Plug-Cap	17	145-5989	1	Seal-Oil
12	140-7131	1	Plug-Cap	19	140-7130	1	Dipstick

Tensioner Assembly No. 140-9027

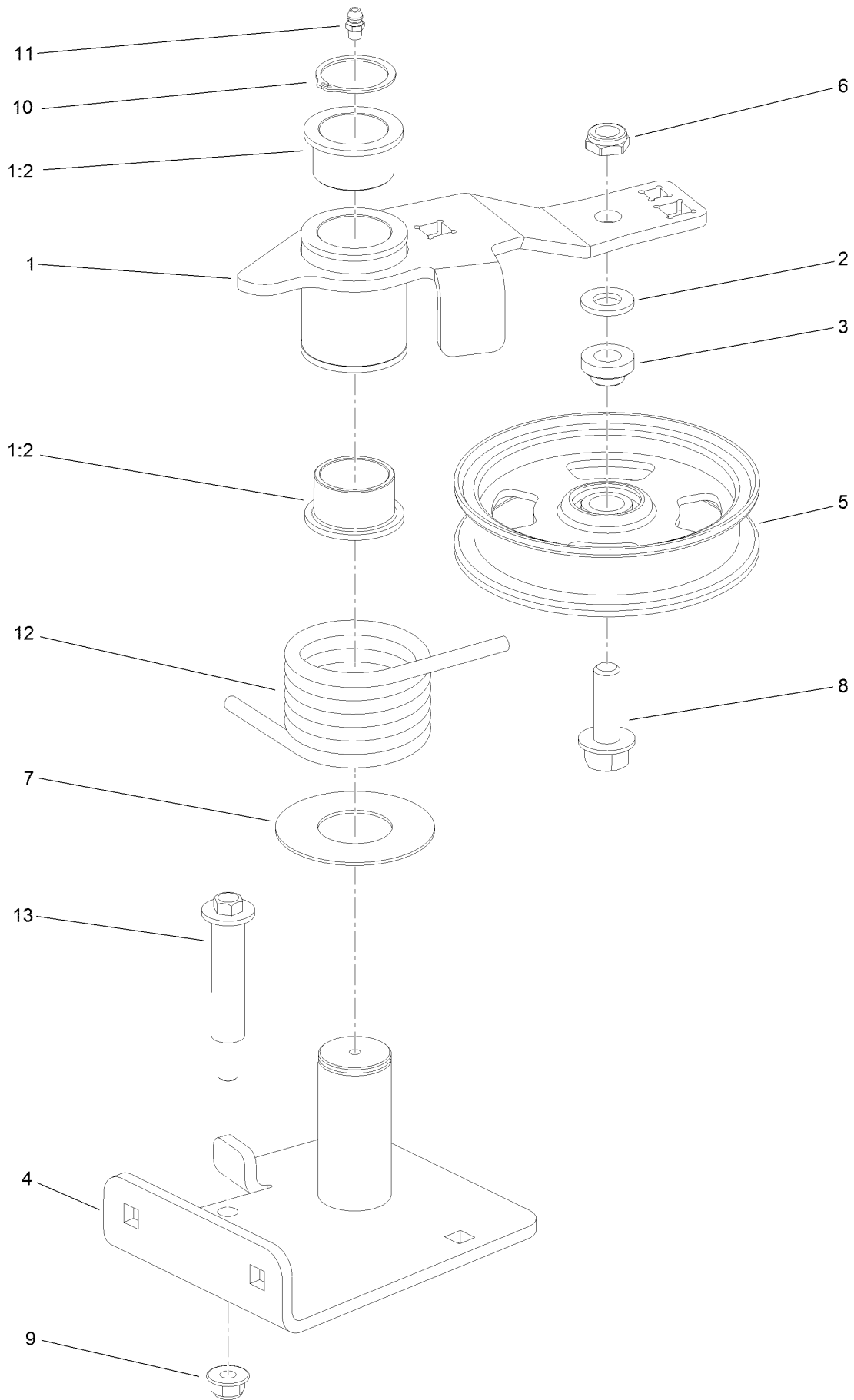

Tensioner Assembly No. 140-9027 (continued)

<i>Ref.</i>	<i>Part Number</i>	<i>Qty.</i>	<i>Description</i>	<i>Ref.</i>	<i>Part Number</i>	<i>Qty.</i>	<i>Description</i>
1	144-0503	1	High Idler Arm ASM	7	108-1926	1	Washer
1:2	93-4510	2	Bushing-Caster	8	100-6116	1	Screw-HHF
2	106-9888	1	Washer-Flat	9	104-8301	1	Nut-HF, NI
3	108-1924	1	Spacer-Idler	10	32120-84	1	Ring-Snap, External
4	140-9023	1	Pivot-Idler	11	302-5	1	Fitting-Grease
5	136-5405	1	Pulley-Idler, Flat	12	112-7395	1	Spring-Torsion
6	3296-45	1	Nut-Hex	13	112-3977	1	Bolt-Shoulder

Belt Cover, Caster Arm and Wheel Assembly

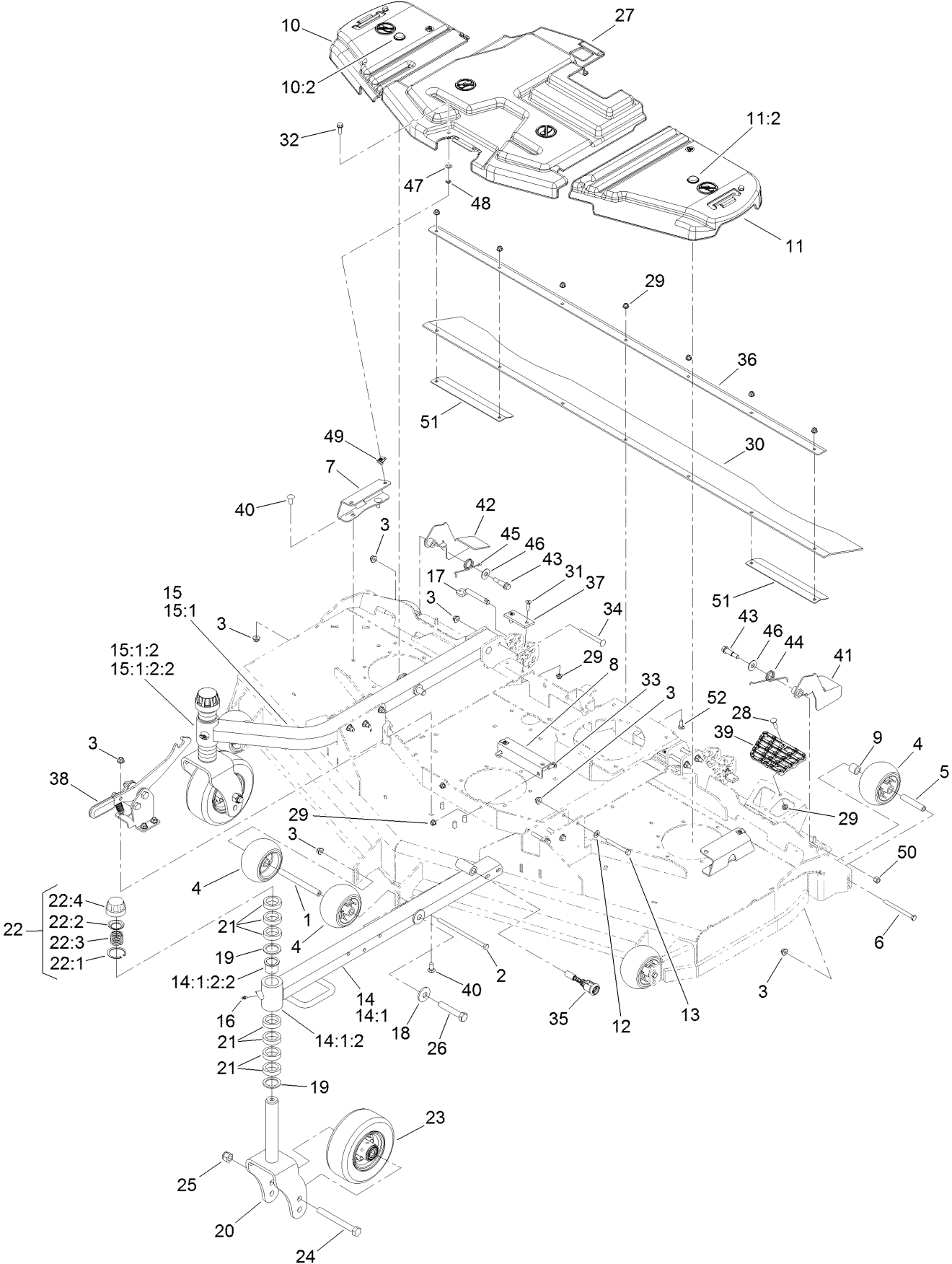

Belt Cover, Caster Arm and Wheel Assembly (continued)

<i>Ref.</i>	<i>Part Number</i>	<i>Qty.</i>	<i>Description</i>	<i>Ref.</i>	<i>Part Number</i>	<i>Qty.</i>	<i>Description</i>
1	98-5967	1	Spacer-Wheel	22:3	92-9726	1	Spring-Compression
2	108-5388	1	Screw-HH	22:4	92-8861	1	Cap-HOC
3	104-8301	23	Nut-HF, NI	23	137-5529	2	Wheel ASM
4	1-603299	6	Roller-Scalp, Anti	24	327-24	2	Screw-HH
5	98-7912	4	Tube-Spanner	25	3296-53	2	Nut-Lock, NI
6	323-23	4	Screw-HH	26	139-6203	2	Screw-HH
7	114-5882-01	2	Bracket-Cover, Belt	27	138-7373	1	Cover-Belt, Center
8	140-3066-03	1	Bracket-Belt Cover, Middle (CE)	28	3230-3	1	Screw-CARR
9	98-7913	4	Tube-Spacer	29	104-8300	14	Nut-HF, NI
10	117-7815	1	RH Belt Cover ASM	30	139-0908	1	Flap Rubber
10:2	117-3824	1	Plug-Plastic	31	133-4543	4	Screw
11	117-7816	1	LH Belt Cover ASM	32	3234-29	3	Screw-HHF
11:2	117-3824	1	Plug-Plastic	33	3230-10	2	Bolt-CARR
12	3256-24	6	Washer-Plain	34	3231-11	4	Screw-CARR
13	323-20	6	Screw-HH	35	139-6345	1	Spring-Pin
14	137-2481-01	1	Arm-Caster, LH	36	139-0909-01	1	Bracket-Flap
14:1		1	Arm-Caster, LH ●	37	138-4452	2	Pad-Stop, Deck
14:1:2		1	Hub ASM ●	38	139-0888	1	Latch ASM
14:1:2:2	69-6470	2	Bushing-Caster	39	126-4781	1	Step-Deck
15	137-2485-01	1	Arm-Caster, RH	40	3231-27	8	Screw-CARR
15:1		1	Arm-Caster, RH ●	41	139-6324-03	1	Guard LH ASM
15:1:2		1	Hub ASM ●	42	139-6321-03	1	Guard RH ASM
15:1:2:2	69-6470	2	Bushing-Caster	43	66-0561	2	Screw-Shoulder
16	302-5	2	Fitting-Grease	44	51-4380	1	Spring-Torsion, LH
17	140-3064	2	Pin-HOC ASM	45	51-4370	1	Spring-Torsion, RH
18	103-0865	2	Washer-Blade Bolt, Heavy	46	3-6803	2	Washer-Adjusting
19	69-6860	4	Washer-Thrust	47	73-0041	3	Washer-Thrust
20	137-2546-01	2	Fork-Caster	48	117-2749	3	Nut-Push
21	69-1510	14	Spacer	49	94-2413	3	Nut-U
22	92-9727	2	HOC Cap ASM	50	3296-6	2	Nut-Lock
22:1	92-5581	1	Ring-Rtng, Snap, Int, Flat	51	144-0529-0P	2	Plate-Support, Flap
22:2	92-5583	1	Washer-Cap	52	3230-22	7	Screw-CARR

● Not serviced separately

Wheel Assembly No. 137-5529

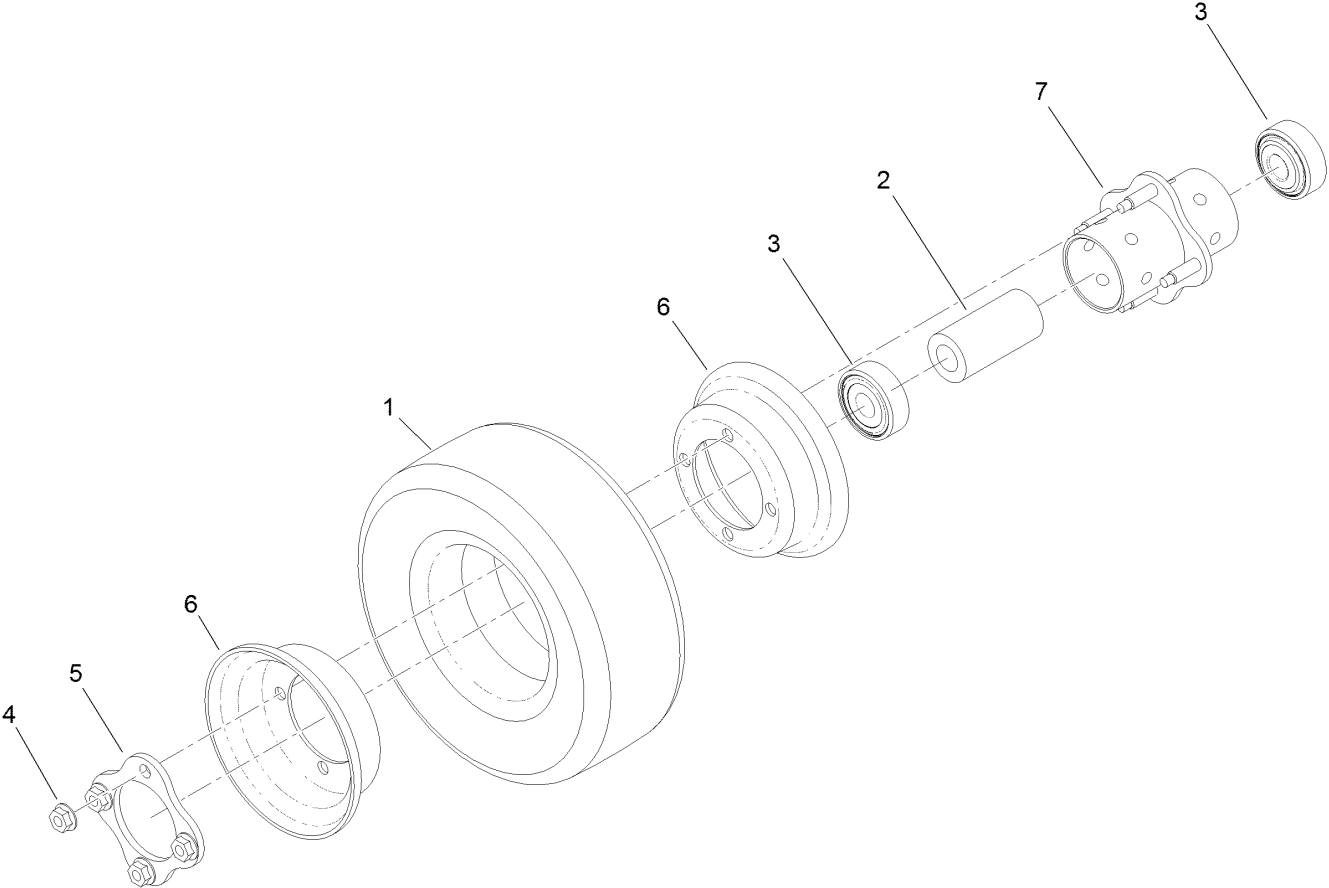

Wheel Assembly No. 137-5529 (continued)

<i>Ref.</i>	<i>Part Number</i>	<i>Qty.</i>	<i>Description</i>
1	136-4424	1	Tire-Pneumatic, Semi
2	93-4241	1	Spacer-Bearing, Inner
3	120-3366	2	Bearing
4	32128-16	4	Nut-HHF

<i>Ref.</i>	<i>Part Number</i>	<i>Qty.</i>	<i>Description</i>
5	93-4242	1	Plate
6	137-5552	2	Rim-Wheel, Half
7	93-5980	1	Hub

Latch Assembly No. 139-0888

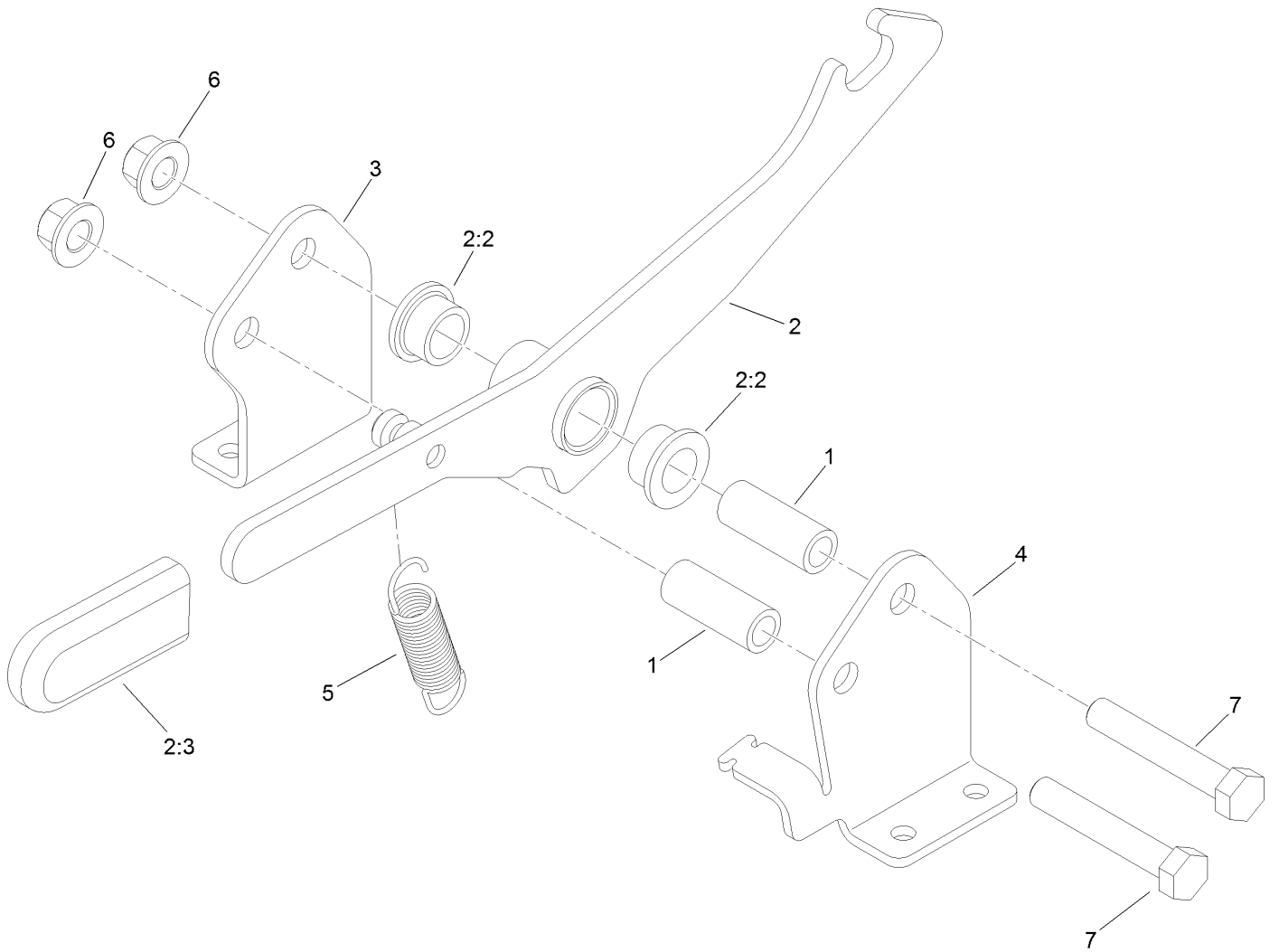

Latch Assembly No. 139-0888 (continued)

<i>Ref.</i>	<i>Part Number</i>	<i>Qty.</i>	<i>Description</i>
1	117-0380	2	Spacer
2	138-0283	1	Latch Arm ASM
2:2	93-2877	2	Bushing
2:3	119-1846	1	Grip
3	139-0889	1	Bracket-Latch, Mount (RH)

<i>Ref.</i>	<i>Part Number</i>	<i>Qty.</i>	<i>Description</i>
4	139-0887	1	Bracket-Latch, Mount (LH)
5	130-9645	1	Spring-Extension
6	99-5107	2	Nut-Lock
7	325-12	2	Screw-HH

Notes:

Notes:



Count on it.