



Count on it.

Parts Catalog

Brush Cutter

Model No. 33522—Serial No. 411000000 and Up



Ordering Replacement Parts

To order replacement parts, please supply the part number, the quantity, and the description of each part desired.

Understanding Reference Numbers

Each identified part in an illustration has a reference number. The reference number for a part also appears in the parts list, along with other information about the part.

This catalog uses two special reference number formats, one to indicate parts in a service assembly and another to indicate the quantity of a given part in an illustration.

Service Assembly Reference Numbers

Parts in service assemblies have reference numbers in the form a:b. The a represents the reference number of the entire service assembly and the b represents a sequential number unique to each part within the service assembly.

For example, a wheel assembly might be identified by reference number 6, the tire by 6:1, the valve by 6:2, and the wheel by 6:3. When you order the assembly identified by reference number 6, you receive all parts identified by reference numbers 6:1, 6:2, and 6:3. However, you may also order any part individually. Reference numbers of this type appear in illustration and in parts lists.

Reference Numbers Indicating Quantity

In an illustration, if a reference number indicates more than one part, the reference number has the form nX y. The n represents the quantity of the part, the X is the multiplication symbol, and the y represents the reference number.

For example, in an illustration, the reference number 2X 37 means that two of the parts identified by reference number 37 are indicated.

Contents

Engine and Frame Assembly	4
Drive Assembly	6
Transmission Assembly No. 121-1908	8
Deck Assembly	10
Handle Assembly	12
Electrical Assembly	14
Fuel System Assembly	16
Air Intake and Filtration Assembly	18
Ignition and Electrical Assembly	20
Crankcase Assembly	22
Governor Control Assembly	24
Piston and Cylinder Head Assembly	26
Blower Housing Assembly	28
Gasket and Seal Kit	30
Attachments and Accessories	32

Engine and Frame Assembly

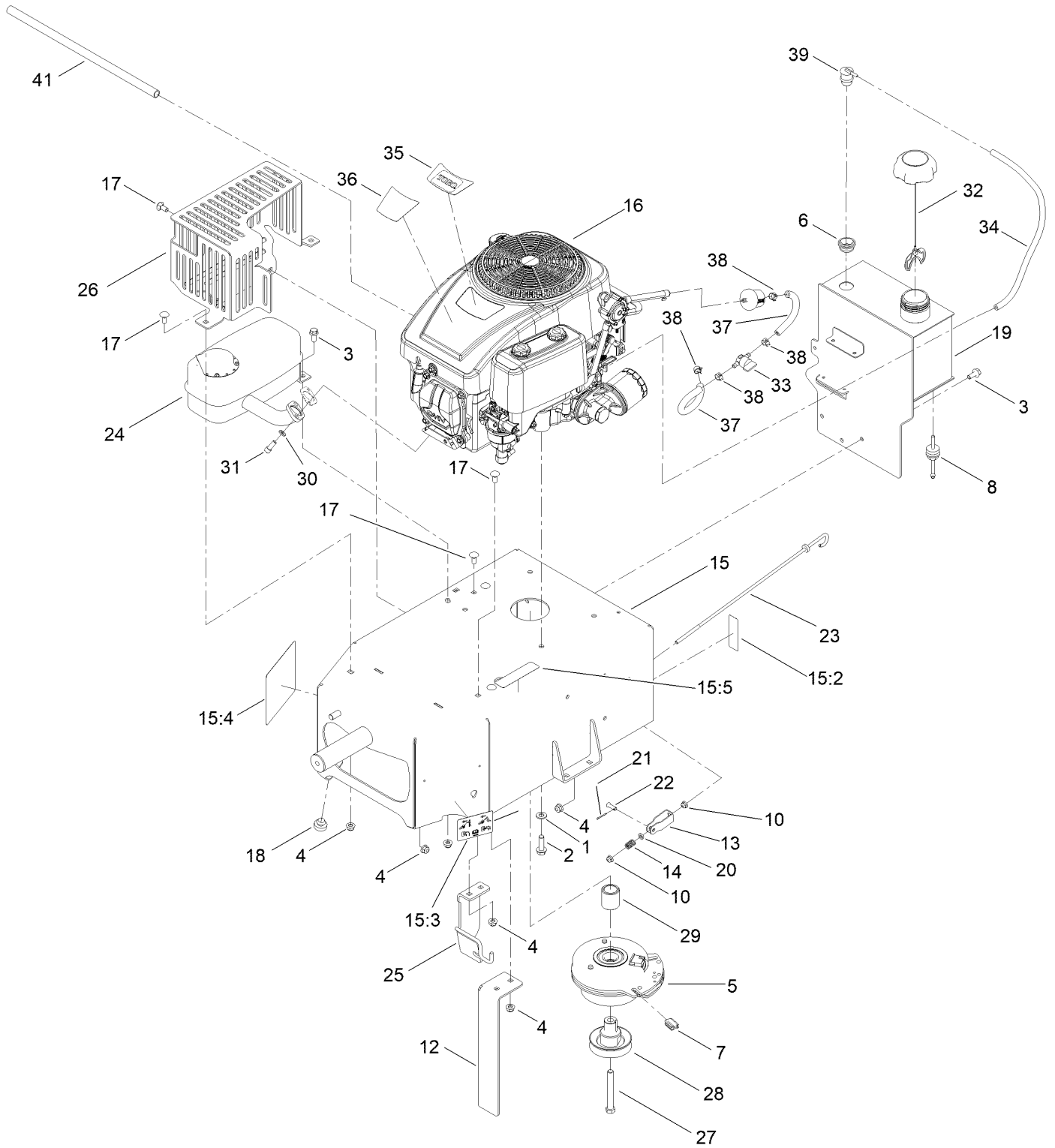

Engine and Frame Assembly (continued)

<i>Ref.</i>	<i>Part Number</i>	<i>Qty.</i>	<i>Description</i>	<i>Ref.</i>	<i>Part Number</i>	<i>Qty.</i>	<i>Description</i>
1	3256-24	4	Washer-Flat	21	3272-4	1	Pin-Cotter
2	32144-109	4	Screw-Thd	22	1-808265	1	Pin-Clevis
3	3234-47	4	Screw-HHF	23	136-1412	1	Rod-Brake
4	104-8300	12	Nut-HF, NI	24	136-1423	1	Muffler
5	136-1425	1	Clutch-Electric	25	133-9711-01	1	Guide-Belt/Cable
6	114-0284	1	Grommet	26	136-1429-03	1	Guard-Muffler
7	120-2217	1	Isolator-Clutch	27	3212-14	1	Screw-HH
8	103-2605	1	Fitting-Fuel, Bulkhead	28	136-1424	1	Pulley-Hydro
10	104-7201	2	Nut-HF, NI	29	136-1415	1	Spacer-Clutch
12	132-4060-01	1	Bracket-Torque	30	3253-4	2	Washer-Lock
13	39-3080	1	Clevis	31	3274-10	2	Screw-HSH
14	63-4220	1	Spring-Compression	32	137-4127	1	Cap-Fuel
15	136-4626	1	Frame ASM	33	1-603770	1	Valve-Fuel
15:2	115-9625	1	Decal-Brake, Parking	34	110-8751	1	Hose-Fuel
15:3	136-4646	1	Decal-Bypass	35	125-1700	1	Decal-Engine
15:4	137-0653	1	Decal-Service	36	130-0682	1	Decal-Displacement, Engine
15:5	133-8062	1	Decal-Arrestor, Spark	37	109-0660	2	Hose-Fuel
16	140-1142	1	Kit-Engine, Svc Lc1P92F-1	38	2412-98	4	Clamp-Hose
17	3230-1	8	Bolt-CARR	39	119-3547	1	Valve-Vent, Fuel
18	104-1412	2	Bumper-Rubber	41	106-7022	1	Tube-Drain, Oil
19	145-4944	1	Tank-Fuel				
20	55-9620	1	Spacer-Plate, Pivot				

Drive Assembly

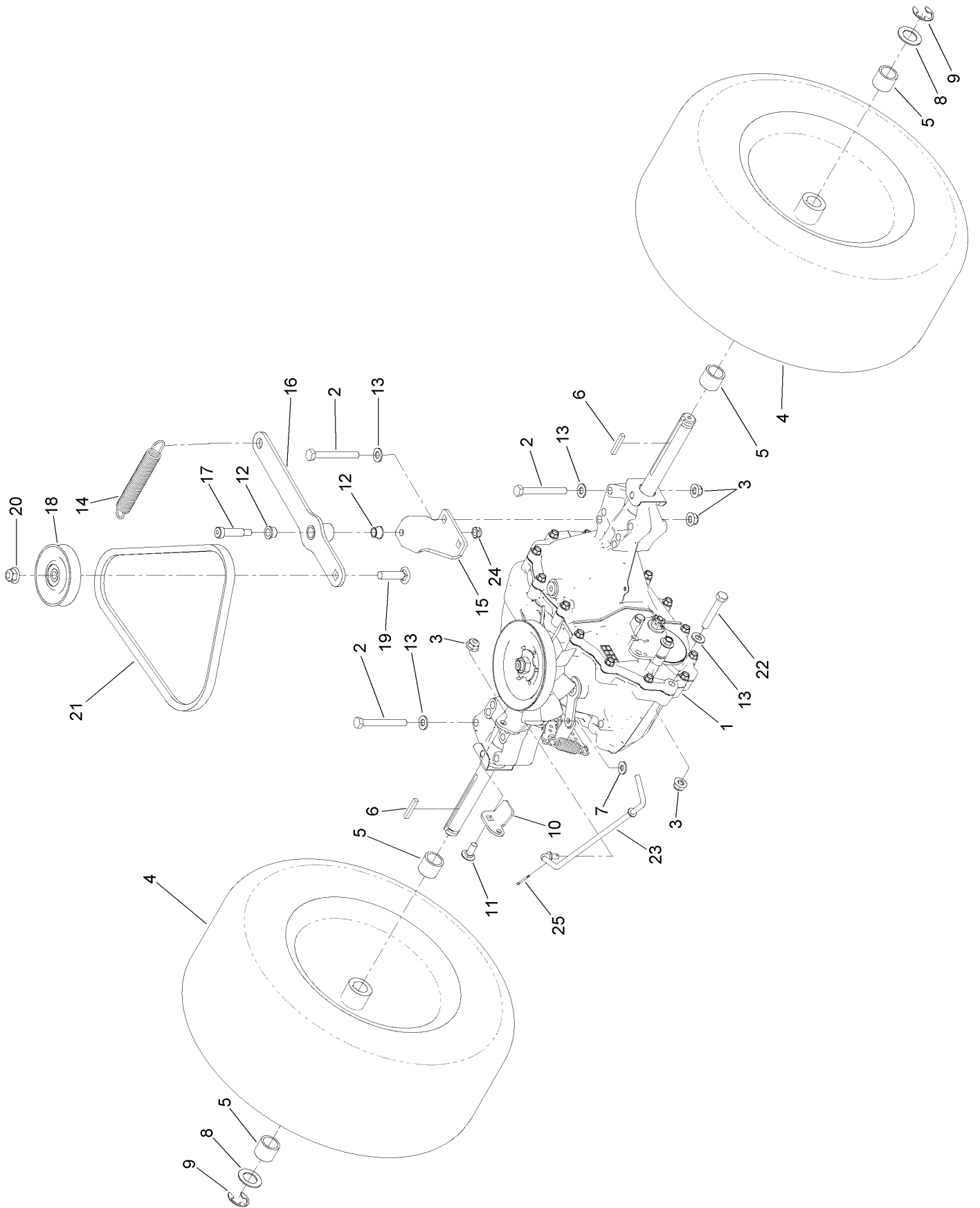

Drive Assembly (continued)

<i>Ref.</i>	<i>Part Number</i>	<i>Qty.</i>	<i>Description</i>	<i>Ref.</i>	<i>Part Number</i>	<i>Qty.</i>	<i>Description</i>
1	121-1908	1	Transaxle ASM ●	14	21-1830	1	Spring-Extension
2	322-13	6	Screw-HH	15	132-4079-03	1	Mount-Arm, Tension
3	104-8300	8	Nut-HF, NI	16	132-4061-03	1	Arm-Tension, Belt
4	132-7001	2	Tire ASM	17	114-0239	1	Screw-HSH
5	132-4062	4	Spacer	18	62-4530	1	Pulley
6	92-0049	2	Key-Square	19	3231-26	1	Screw-CARR
7	3256-22	1	Washer-Flat	20	104-8301	1	Nut-HF, NI
8	67-9410	2	Washer	21	707081	1	V-Belt
9	32151-48	2	E-Ring	22	322-10	1	Screw-HH
10	132-7048-03	1	Bracket-Cable	23	133-9715	1	Lever-Valve, Tow
11	3230-23	1	Bolt-CARR	24	3296-47	1	Nut-Lock,NI
12	132-4097	2	Bushing	25	3272-4	1	Pin-Cotter
13	3256-23	7	Washer-Plain				

● Apply anti-seize compound to axle ends before installing tires.

Transmission Assembly No. 121-1908

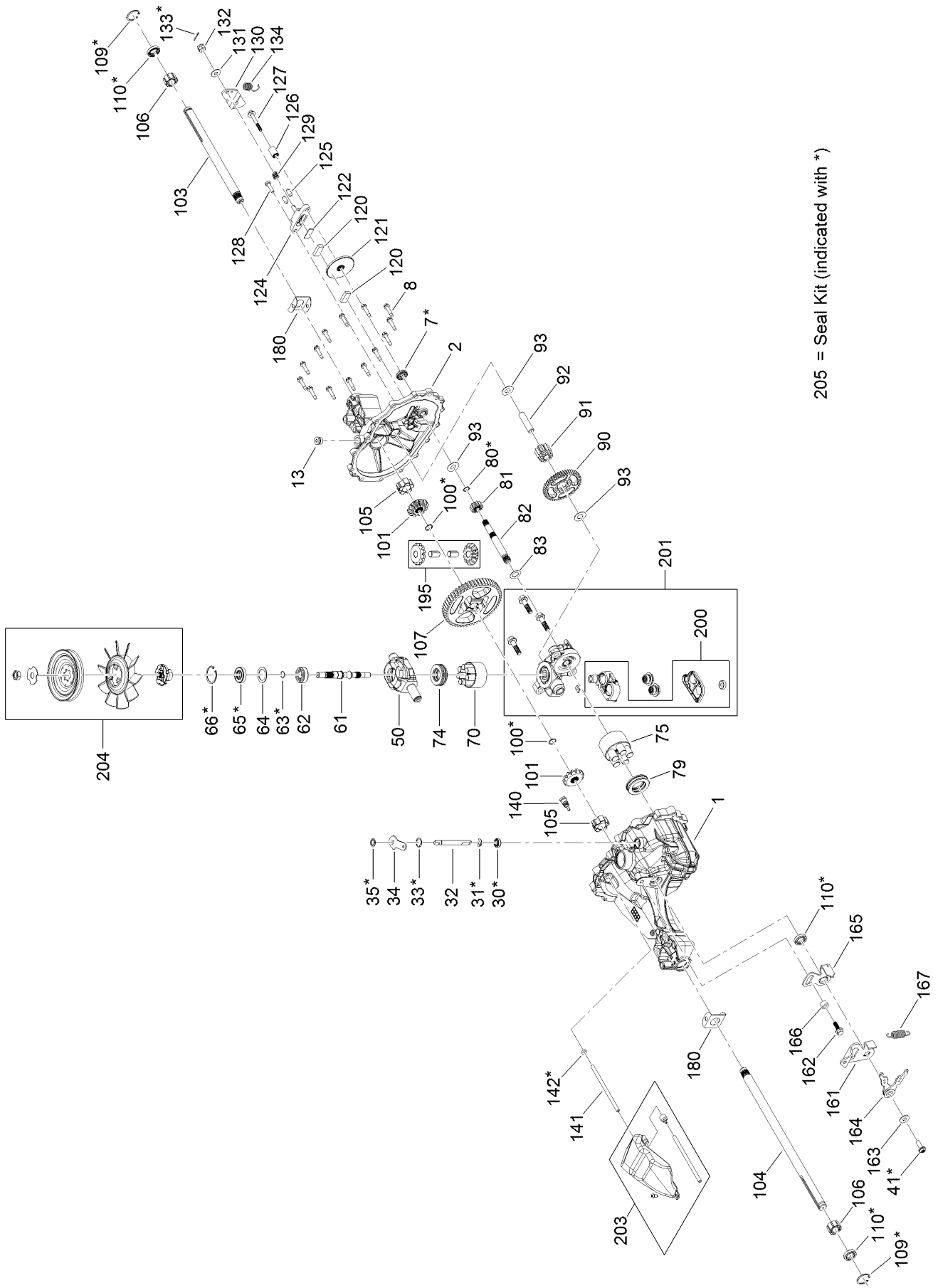

205 = Seal Kit (indicated with *)

Transmission Assembly No. 121-1908 (continued)

<i>Ref.</i>	<i>Part Number</i>	<i>Qty.</i>	<i>Description</i>	<i>Ref.</i>	<i>Part Number</i>	<i>Qty.</i>	<i>Description</i>
1	115-8313	1	Main Housing Kit	105	115-8314	2	Bushing-Inboard
2	119-5538	1	Housing Side Kit	106	115-8304	2	Bushing-Outboard
7	115-8335	1	Seal-Lip	107	115-8325	1	Gear-53T, Bull
8	117-5359	14	Screw-HHF	109	115-8303	2	Ring-Retaining, Internal
10	104-2147	1	Sealant ●	110	121-0970	3	Seal-Lip
13	104-2189	1	Plug-Thread, Straight	120	104-2171	2	Puck-Brake
30	106-8676	1	Seal-Lip	121	115-8337	1	Rotor-Brake
31	106-8677	1	Ring-Retaining, External	122	104-2181	1	Puck-Plate
32	115-8312	1	Rod-Bypass, Actuator	124	104-5341	1	Bearing-Block, Center
33	106-8679	1	Ring-Retaining, Internal	125	104-2176	2	Pin-Brake
34	115-8311	1	Arm-Bypass	126	104-2180	1	Spacer
35	106-8681	1	Ring-Retaining, External	127	104-5345	1	Screw-HF
41	107-2488	1	Screw	128	115-8339	1	Screw-HHCS
50	115-8319	1	Trunnion-Plate, Swash	129	104-2188	1	Spring-Brake, Anti Drag
61	115-8317	1	Shaft-Input	130	112-6195	1	Brake-Arm
62	94-1904	1	Bearing-Shaft, Ball	131	114-8491	1	Washer
63	119-5531	1	Ring-Retaining, Wire	132	119-5543	1	Nut-Castle
64	104-2104	1	Spacer	133	3272-7	1	Pin-Cotter
65	119-5532	1	Seal-Lip	134	104-2184	1	Spring-Arm, Brake (Bias)
66	119-5533	1	Ring-Retaining	140	104-5349	1	Fitting-SAE
70	121-0967	1	Piston Block ASM	141	115-8302	1	Hose
74	115-8320	1	Bearing-Thrust, Ball	142	104-5361	1	O-Ring
75	103-2666	1	Cylinder Block Kit	161	115-8308	1	Arm-Control, Return
79	94-6922	1	Bearing-Thrust	162	104-5312	1	Screw-HF
80	115-8331	1	Ring-Retaining, External	163	114-8491	1	Washer
81	119-5539	1	Gear-Pinion	164	115-8306	1	Bi Directional Return Kit
82	115-8329	1	Shaft-Motor	165	115-8310	1	Arm-Neutral
83	115-8328	1	Washer	166	115-8309	1	Bushing
90	119-5540	1	Gear	167	115-8307	1	Spring-Extension
91	115-8333	1	Gear-Jackshaft, 11T	180	119-5527	2	Spring Clip-Housing Thrust
92	115-8334	1	Pin-Jackshaft	195	137-0656	1	Miter Gears W/Pins Kit
93	94-1933	3	Washer	200	115-8323	1	Filter Kit
100	104-5328	2	Ring-Retaining, Spiral	201	137-0657	1	Centersection W/Filter Kit
101	115-8315	2	Gear-Bevel, 12T (Spline, ID)	203	115-8301	1	Expansion Tank Kit
103	121-0968	1	Shaft-Axle, Keyed	204	137-0658	1	Fan/Pulley Kit
104	121-0969	1	Shaft-Axle, Keyed	205	115-8316	1	Seal Kit

● Not illustrated

Deck Assembly

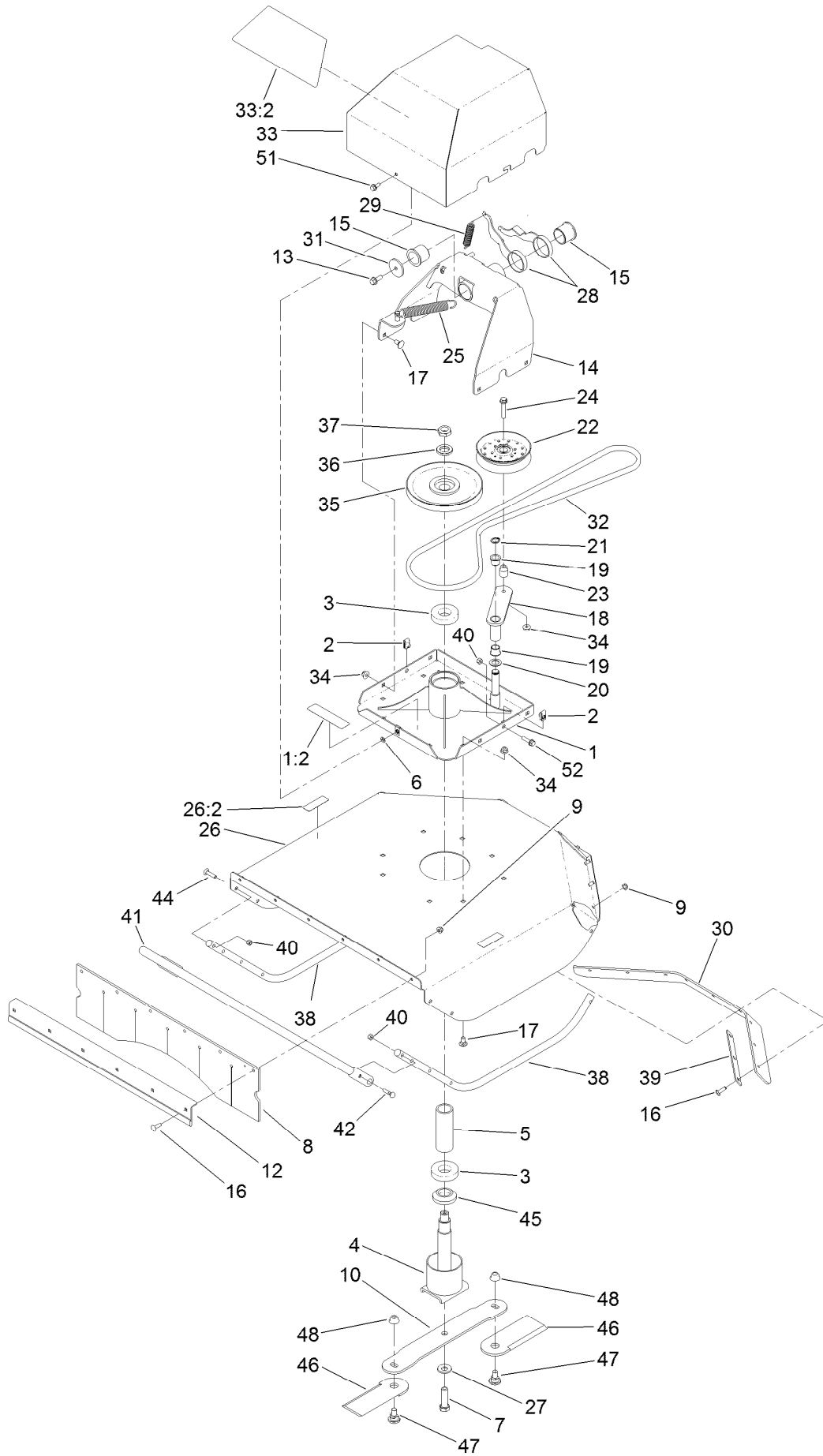

Deck Assembly (continued)

<i>Ref.</i>	<i>Part Number</i>	<i>Qty.</i>	<i>Description</i>	<i>Ref.</i>	<i>Part Number</i>	<i>Qty.</i>	<i>Description</i>
1	136-4637	1	Spindle ASM	26:2	130-9670	2	Decal-Warning, Blade
1:2	93-7814	1	Decal-Danger	27	125-1736	1	Washer-Belleville
2	94-2413	3	Nut-U	28	132-4064-03	2	Arm-Return
3	132-4088	2	Bearing-Spindle	29	13-0480	1	Spring
4	132-7040	1	Spindle Cup ASM	30	133-9700	1	Flap-Deck
5	132-7006	1	Spacer-Bearing	31	132-4055	1	Washer-Flat
6	117-2749	1	Nut-Push	32	132-7047	1	Belt-Deck
7	51-4060	1	Screw-Blade	33	136-4627	1	Guard-Belt
8	136-4599	1	Flap-Rubber	33:2	132-4011	1	Decal
9	104-8300	15	Nut-HF, NI	34	104-8301	13	Nut-HF, NI
10	132-4066	1	Blade-Flail	35	104-3546	1	Pulley-Driven, Low
12	136-1421-01	1	Guard-Flap, Rubber	36	120-5576	1	Washer-Hardened
13	3234-11	1	Screw-HHF	37	3296-60	1	Nut-Lock, NI
14	132-7044-03	1	Frame-Pivot	38	132-7008-03	2	Bar-Skid
15	132-4091	2	Bushing	39	133-9709-03	3	Plate-Flap, Deck
16	3230-22	15	Screw-CARR	40	3296-29	12	Nut-Lock, NI
17	3231-1	12	Screw-CARR	41	132-7009-03	1	Guard-Brush
18	132-7033-03	1	Arm-Tension	42	130-2356	4	Screw-Handle, Lock
19	132-4089	2	Bushing	44	112-6950	6	Screw-CARR
20	67-9410	1	Washer	45	136-4609	1	Cap-Spindle
21	32120-93	1	Ring-Retaining	46	132-4067	2	End-Blade
22	116-4665	1	Pulley-Idler, Flat	47	132-4069	2	Bolt
23	1-633456	1	Bushing, Idler	48	131-0703	2	Nut-HHF
24	108-3742	1	Screw-HHF	51	3234-5	1	Screw-HHF
25	106-2177	1	Spring-Extension	52	3234-36	2	Screw-HHF
26	136-4625	1	Deck ASM				

Handle Assembly

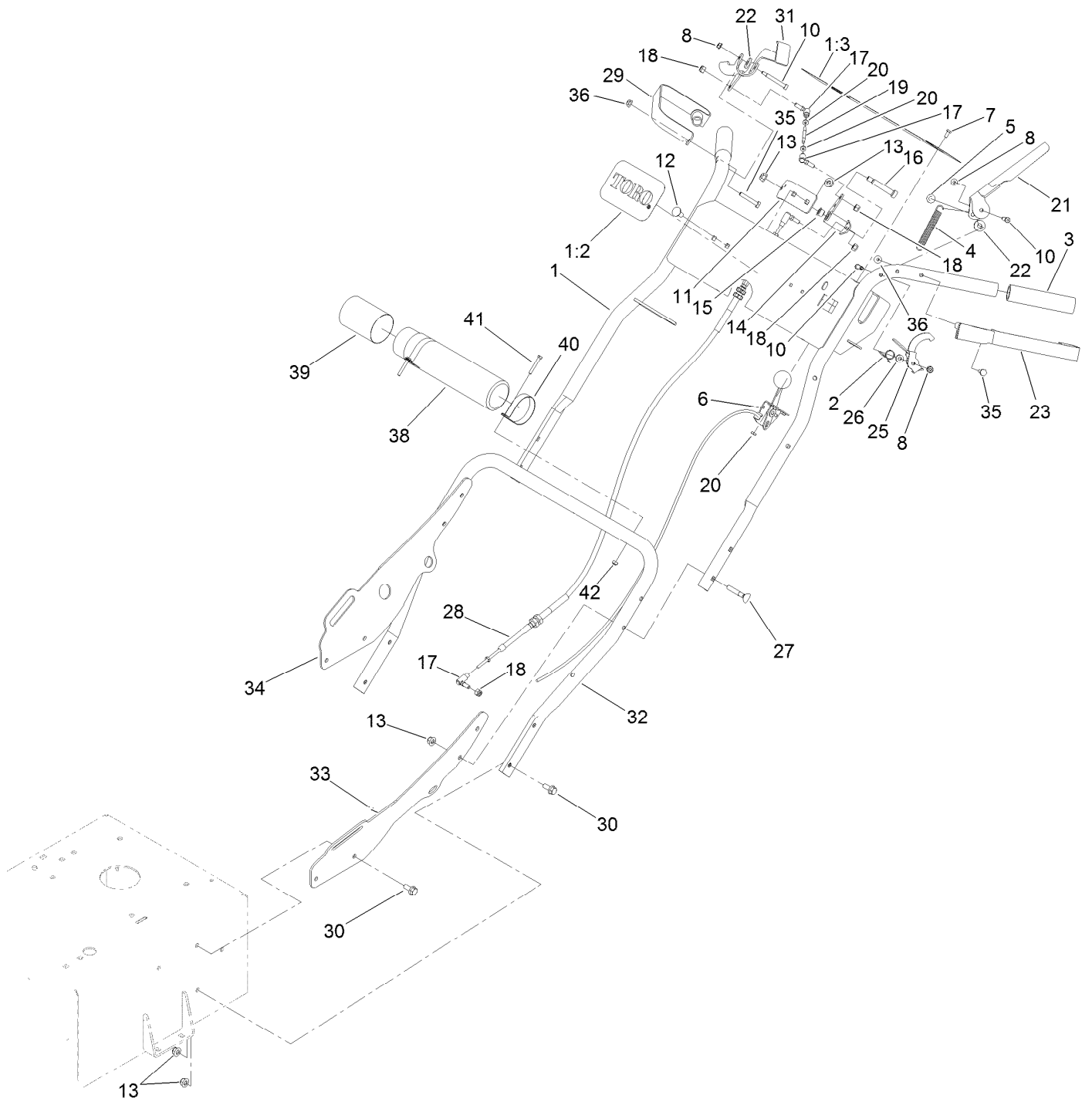

Handle Assembly (continued)

<i>Ref.</i>	<i>Part Number</i>	<i>Qty.</i>	<i>Description</i>	<i>Ref.</i>	<i>Part Number</i>	<i>Qty.</i>	<i>Description</i>
1	136-4624	1	Handle ASM	21	132-7029-03	1	Handle-Clutch
1:2	105-8278	1	Decal	22	88-7200	2	Washer-Flat
1:3	132-4005	1	Decal-Operation, Safety	23	136-4633-03	1	Guard-Knuckle
2	132-4085	1	Spring	25	136-4596	1	Lockout
3	136-1433	2	Grip-Foam	26	136-4595	1	Spacer
4	95-3805	1	Spring	27	92-2260	4	Screw-Handle
5	32112-11	1	Nut-Push	28	132-4095	1	Cable-Traction
6	136-1442	1	Cable-Throttle	29	136-1430-03	1	Guard- Knuckle
7	25-8640	2	Screw-HH	30	3234-47	8	Screw-HHF
8	32128-17	3	Nut-Lock, Flange	31	132-4049-03	1	Handle-Traction
10	137-0550	3	Bolt-Shoulder	32	133-9714-03	1	Handle-Lower
11	132-7023-03	1	Mount-Bell Crank	33	133-9716-03	1	Brace-Handle, LH
12	3230-1	2	Bolt-CARR	34	133-9717-03	1	Brace-Handle, RH
13	104-8300	15	Nut-HF, NI	35	321-9	2	Screw-HH
14	132-7024-03	1	Bell Crank ASM	36	104-7201	2	Nut-HF, NI
15	132-4097	2	Bushing	38	104-7050	1	Tube-Manual
16	126-0277	1	Screw-Shoulder	39	104-7048	1	Cap-Housing
17	100-8559	4	Ball Joint ASM	40	2412-120	2	Clamp-R
18	3296-3	4	Nut-Lock	41	32105-1	2	Screw-SHH
19	132-4083	1	Link-Control	42	3296-2	2	Nut-Lock, NI
20	3219-14	4	Nut-Hex				

Electrical Assembly

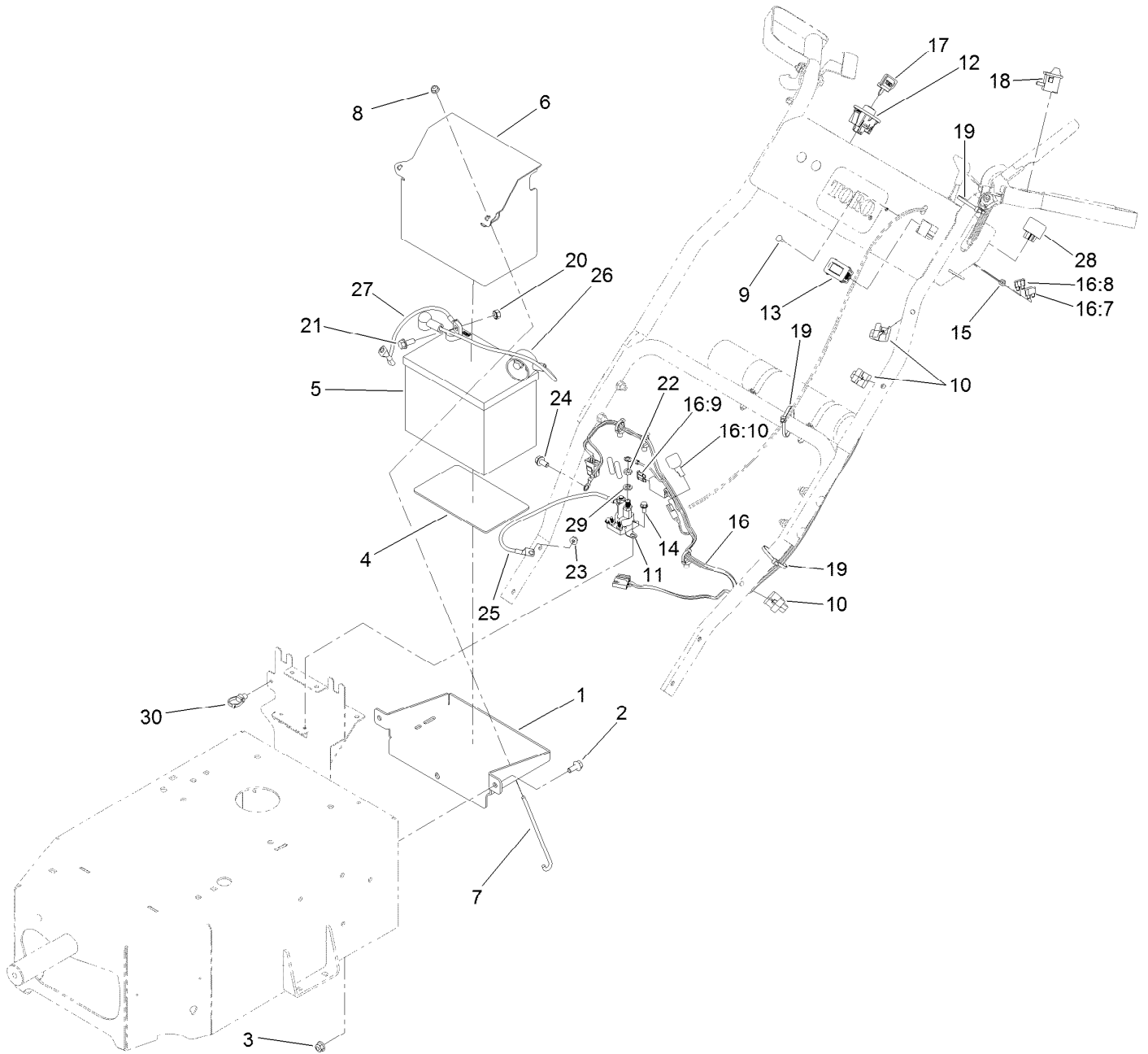

Electrical Assembly (continued)

<i>Ref.</i>	<i>Part Number</i>	<i>Qty.</i>	<i>Description</i>	<i>Ref.</i>	<i>Part Number</i>	<i>Qty.</i>	<i>Description</i>
1	136-1401-01	1	Tray-Battery	16:8	109102	1	Fuse-Blade, 25 Amp
2	3234-47	3	Screw-HHF	16:9	109103	1	Fuse-Blade, 30 Amp
3	104-8300	3	Nut-HF, NI	16:10	100-4918	2	Diode
4	62-4300	1	Pad-Skid, Anti	17	63-8360	1	Key-Ignition
5	105-1692	1	Battery, 230CCA W/O Electrolyte	18	133-4654	1	Switch-Plunger
6	136-1408-01	1	Tray-Battery	19	614249	3	Tie-Cable
7	1-633651	2	Bolt-Holddown	20	32149-1	2	Nut-Keps
8	104-7201	2	Nut-HF, NI	21	3234-5	2	Screw-HHF
9	1-807513	2	Bolt-CARR	22	3220-2	2	Nut-Jam
10	114-7988	3	Guide-Cable	23	33003-00	1	Nut-HF
11	117-1197	1	Solenoid	24	3234-14	1	Screw-HHF
12	137-4100	1	Switch-Ignition	25	122-1000	1	Cable-Battery, Positive
13	120-2244	1	Hourmeter	26	122-0999	1	Cable-Battery, Positive
14	32144-4	2	Screw-HWH	27	122-0959	1	Cable-Battery, Negative
15	3296-2	2	Nut-Lock, NI	28	98-7249	3	Relay
16	122-0925	1	Harness-Wire	29	3253-4	2	Washer-Lock
16:7	218-578	1	Fuse-Blade, 10 Amp	30	32180-030	1	Clip-Tie

Fuel System Assembly

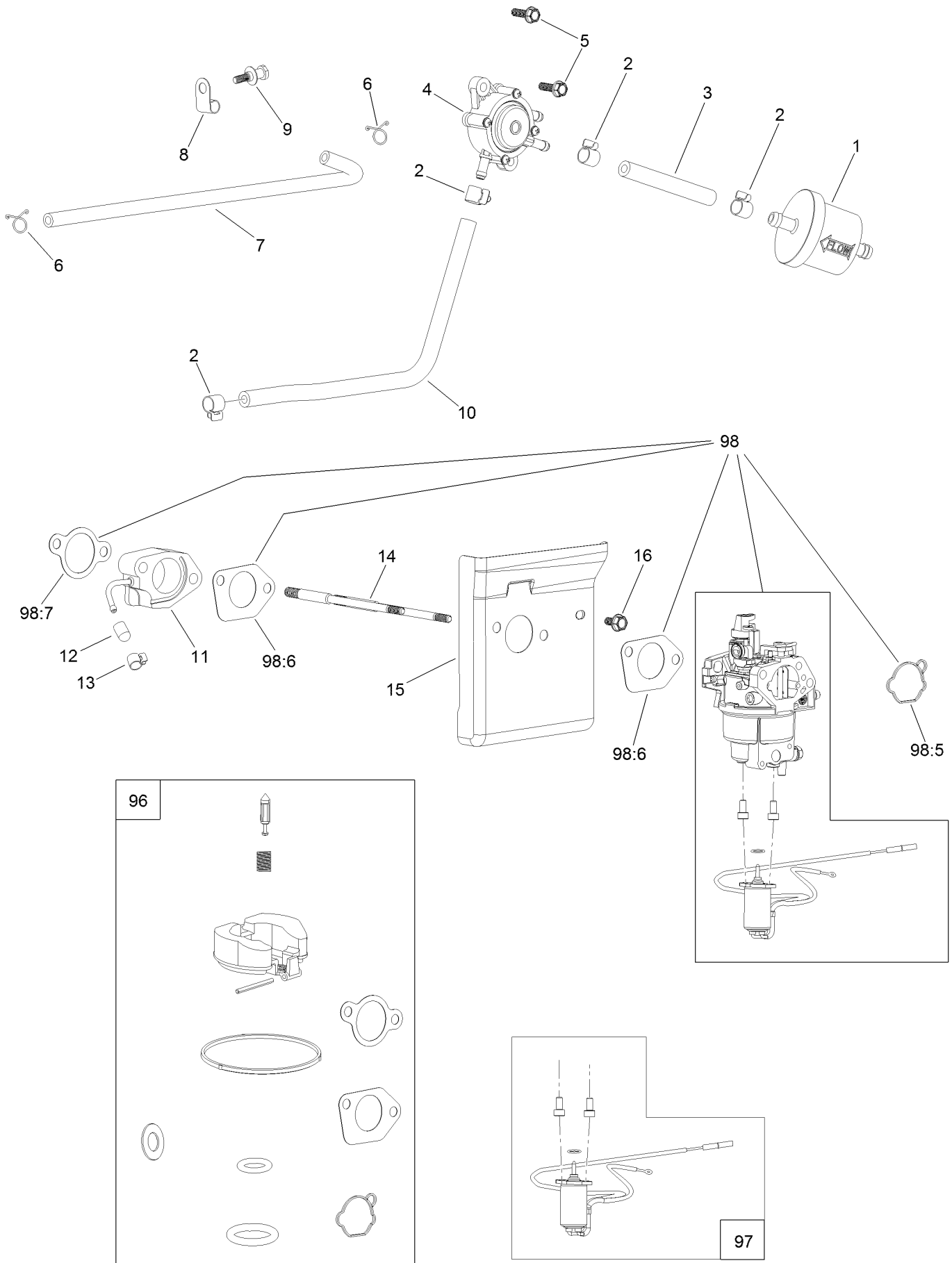

Fuel System Assembly (continued)

<i>Ref.</i>	<i>Part Number</i>	<i>Qty.</i>	<i>Description</i>	<i>Ref.</i>	<i>Part Number</i>	<i>Qty.</i>	<i>Description</i>
1	139-0717	1	Filter-Fuel	13	127-9187	1	Clamp-Hose
2	139-0719	4	Clamp-Fuel Hose	14	120-4202	2	Stud-Mount, Carburetor
3	120-4371	1	Line-Fuel	15	127-9182	1	Shroud
4	139-0685	1	Pump-Fuel	16	120-4216	1	Screw-HHF
5	120-4232	2	Screw-HHF	96	127-9194	1	Carb Repair Kit With Gaskets
6	121-0114	2	Clamp-Hose	97	127-9190	1	Solenoid Kit
7	136-7830	1	Line-Pulse	98	136-7826	1	Carburetor Kit
8	120-4287	1	Clamp-J	98:5	127-9185	1	Gasket-Carburetor
9	120-4217	1	Screw-Shoulder, HH	98:6	120-4247	2	Gasket-Carburetor
10	120-4370	1	Line-Fuel	98:7	120-4250	1	Gasket-Carburetor
11	136-7835	1	Insulator-Carburetor	99	133-9929	1	High Altitude Kit ●
12	127-9189	1	Cap-Seal				

● Not illustrated

Air Intake and Filtration Assembly

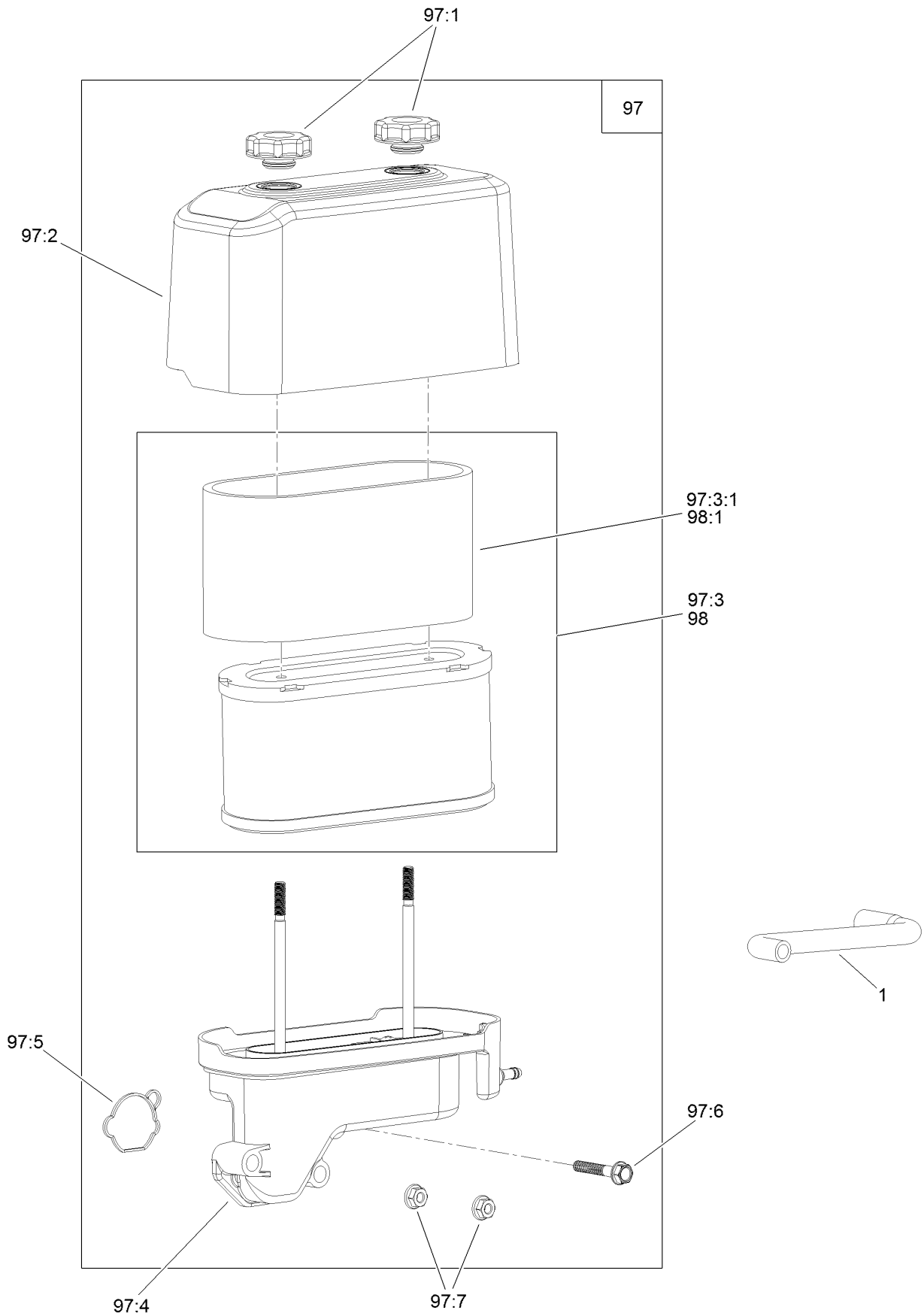

Air Intake and Filtration Assembly (continued)

<i>Ref.</i>	<i>Part Number</i>	<i>Qty.</i>	<i>Description</i>	<i>Ref.</i>	<i>Part Number</i>	<i>Qty.</i>	<i>Description</i>
1	136-7829	1	Tube-Breather	97:4	127-9191	1	Base-Filter, Air
97	136-7814	1	Air Filter ASM	97:5	127-9185	1	Gasket-Carburetor
97:1	120-4312	2	Nut-Speed	97:6	120-4284	1	Screw-HHF
97:2	120-4311	1	Cover-Filter, Air	97:7	120-4236	2	Nut-Flange
97:3	136-7809	1	Air Filter Kit	98	136-7809	1	Air Filter Kit
97:3:1	136-7807	1	Prefilter	98:1	136-7807	1	Prefilter

Ignition and Electrical Assembly

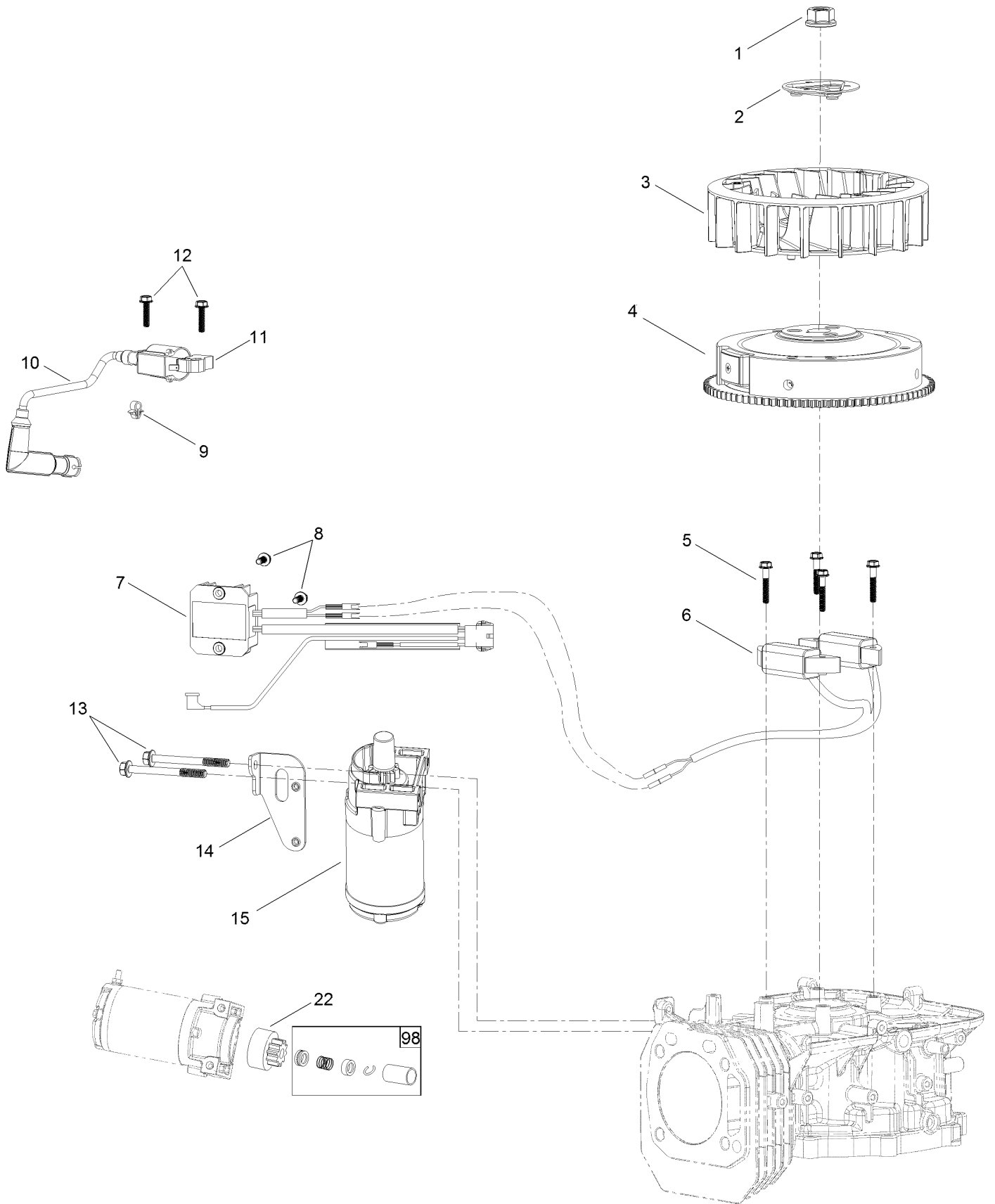

Ignition and Electrical Assembly (continued)

<i>Ref.</i>	<i>Part Number</i>	<i>Qty.</i>	<i>Description</i>	<i>Ref.</i>	<i>Part Number</i>	<i>Qty.</i>	<i>Description</i>
1	120-4213	1	Nut-Flange	10	120-4226	1	Boot-Plug, Spark
2	120-4212	1	Pulley-Starter	11	136-7831	1	Ignition Coil ASM
3	120-4211	1	Fan-Cooling	12	120-4225	2	Screw-HHF
4	120-4399	1	Flywheel	13	120-4231	2	Screw-HHF
5	120-4223	4	Screw-HHF	14	120-4230	1	Bracket-Starter
6	136-7833	1	Alternator	15	136-7832	1	Motor-Starter
7	136-7836	1	Voltage Regulator	22	133-1562	1	Pinion-Starter
8	120-4216	3	Screw-HHF	98	120-4392	1	Starter Repair Kit
9	120-4316	1	Clamp-Wire				

Crankcase Assembly

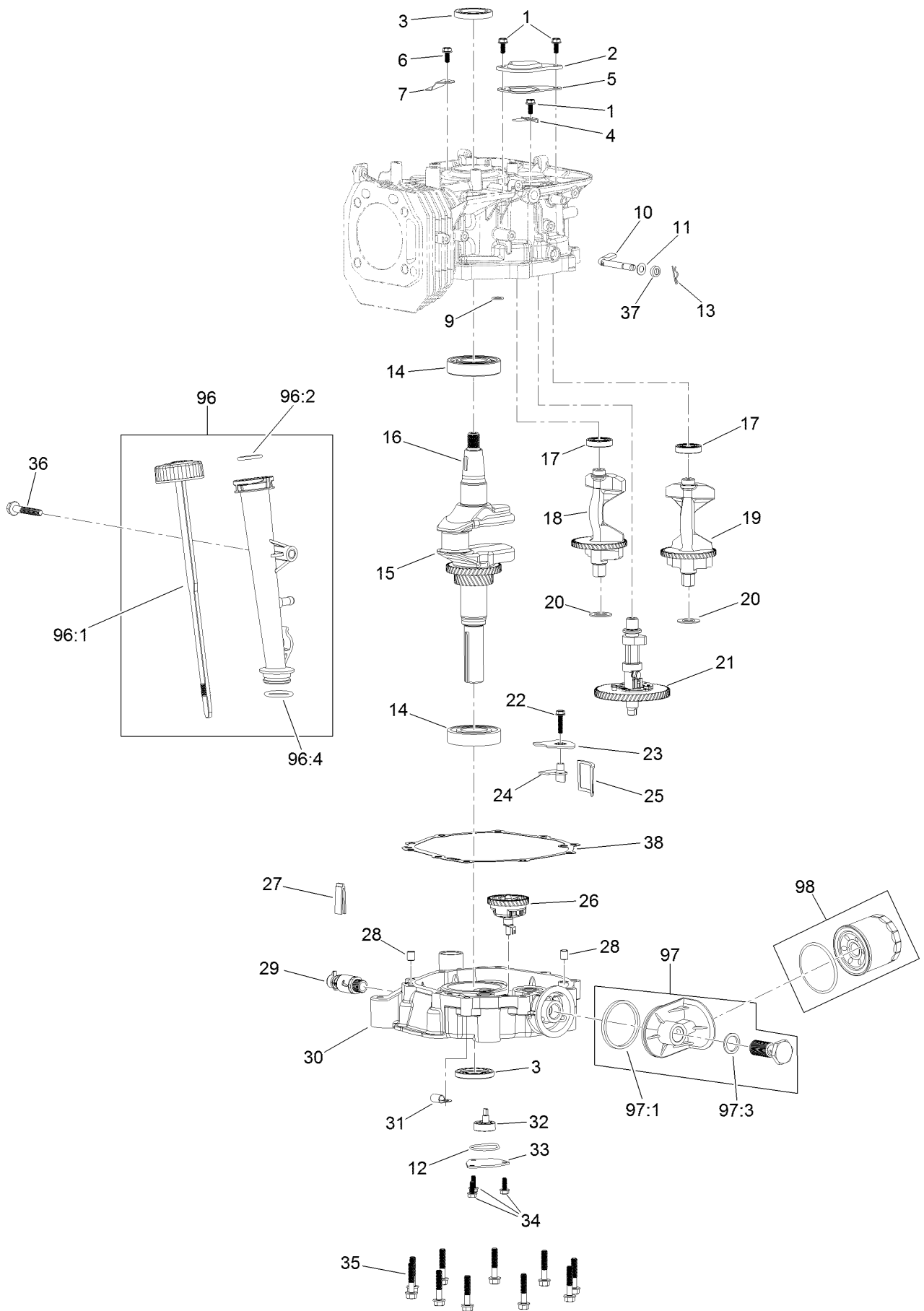

Crankcase Assembly (continued)

<i>Ref.</i>	<i>Part Number</i>	<i>Qty.</i>	<i>Description</i>	<i>Ref.</i>	<i>Part Number</i>	<i>Qty.</i>	<i>Description</i>
1	120-4216	3	Screw-HHF	25	120-4341	1	Strainer-Oil
2	120-4265	1	Plate-Breather	26	136-7834	1	Gear-Governor
3	120-4267	2	Seal-Oil	27	120-4275	1	Deflector-Oil, Rubber
4	120-4263	1	Valve-Reed	28	120-4274	2	Pin-Dowel
5	120-4264	1	Gasket-Breather	29	120-4321	1	Valve-Drain, Oil
6	120-4234	1	Screw-HHF	30	136-7828	1	Cover-Crankcase
7	120-4268	1	Retainer	31	127-9188	1	Clamp-Hose
9	120-4262	1	O-Ring	32	120-4344	1	Oil Pump ASM
10	136-7887	1	Shaft-Governor	33	120-4270	1	Cover-Pump, Oil
11	120-4258	1	Washer-Plain	34	120-4232	3	Screw-HHF
12	120-4343	1	Seal-Pump, Oil	35	120-4273	10	Screw-HHF
13	120-4256	1	Pin-Hair	36	120-4284	1	Screw-HHF
14	120-4261	2	Bearing-Ball	37	120-4257	1	Seal-Oil
15	120-4293	1	Crankshaft	38	120-4260	1	Gasket-Crankcase
16	120-4320	1	Key-Woodruff	96	120-4355	1	Dipstick And Tube Kit
17	120-4266	2	Bearing-Ball	96:1	120-4350	1	Dipstick ASM
18	127-9179	1	Shaft-Balance, R	96:2	120-4348	1	O-Ring
19	127-9180	1	Shaft-Balance, L	96:4	120-4282	1	O-Ring
20	136-7886	2	Washer	97	120-4363	1	Oil Adaptor Kit
21	120-4297	1	Camshaft	97:1	120-4362	1	Seal-Adaptor, Oil
22	120-4225	1	Screw-HHF	97:3	120-4360	1	Washer-Filter, Oil
23	120-4342	1	Cover-Strainer, Oil	98	136-7848	1	Filter-Oil
24	120-4279	1	Plate-Baffle, Oil				

Governor Control Assembly

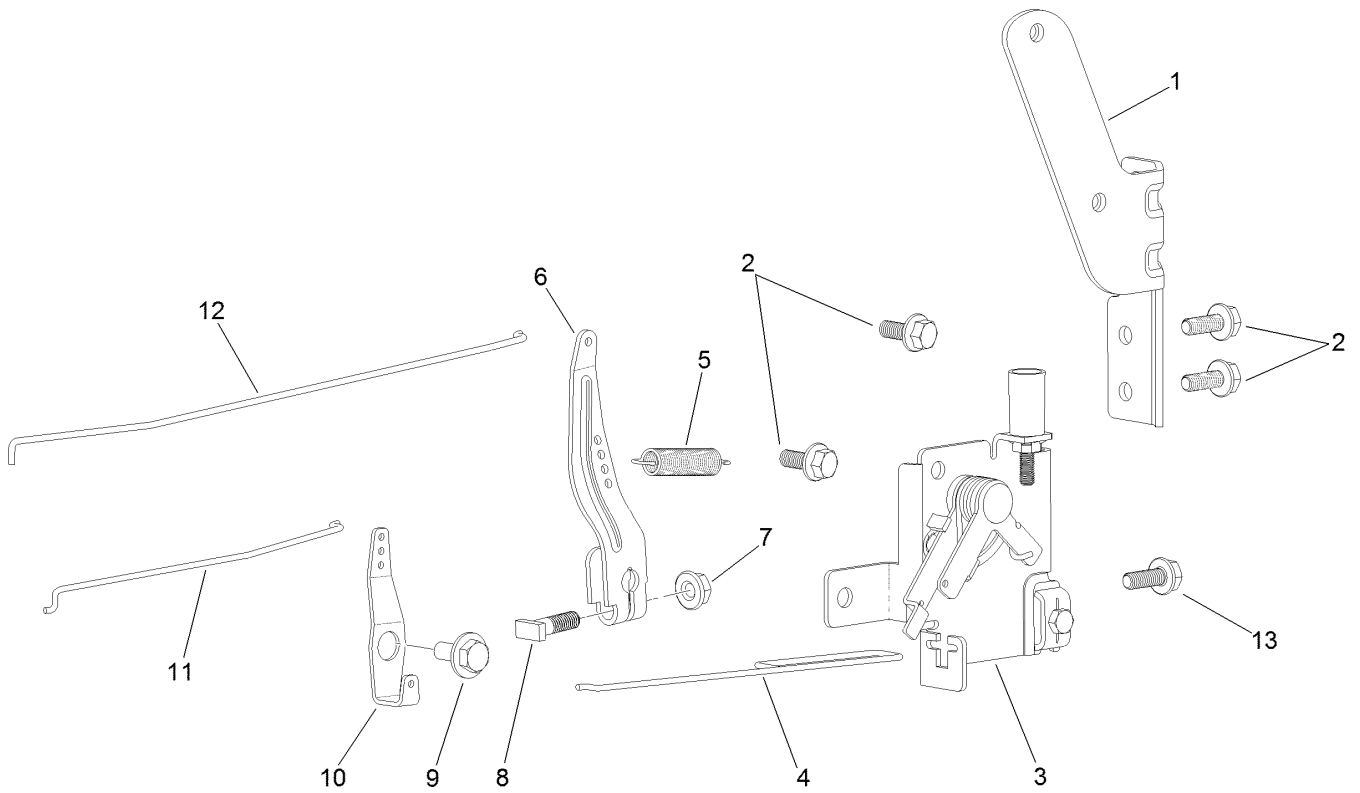

Governor Control Assembly (continued)

<i>Ref.</i>	<i>Part Number</i>	<i>Qty.</i>	<i>Description</i>	<i>Ref.</i>	<i>Part Number</i>	<i>Qty.</i>	<i>Description</i>
1	120-4357	1	Bracket-Pump, Fuel	8	120-4238	1	Bolt-Arm, Governor
2	120-4234	4	Screw-HHF	9	120-4241	1	Screw-Shoulder, HHF
3	120-4358	1	Control-Throttle	10	120-4242	1	Bellcrank-Choke
4	120-4243	1	Rod-Throttle	11	120-4240	1	Rod-Choke
5	120-4337	1	Spring-Governor	12	120-4239	1	Rod-Governor
6	120-4352	1	Arm-Governor	13	120-4232	1	Screw-HHF
7	120-4236	1	Nut-Flange				

Piston and Cylinder Head Assembly

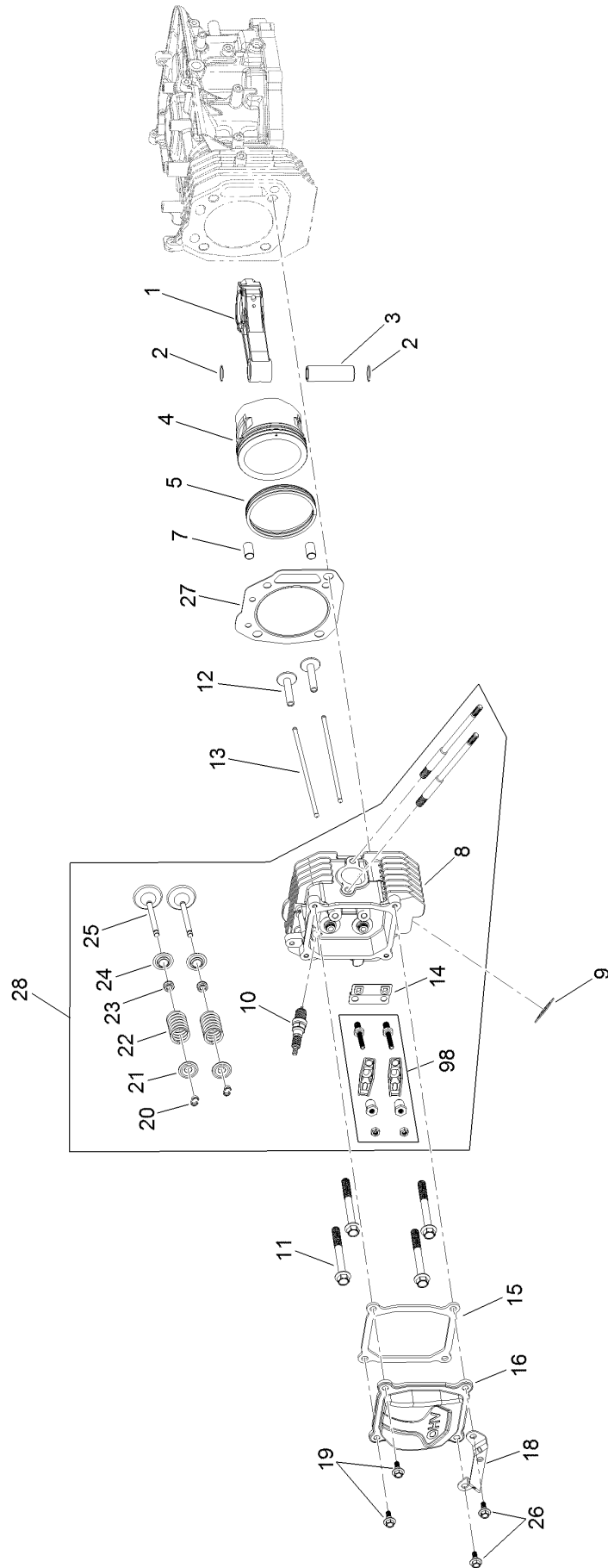

Piston and Cylinder Head Assembly (continued)

<i>Ref.</i>	<i>Part Number</i>	<i>Qty.</i>	<i>Description</i>	<i>Ref.</i>	<i>Part Number</i>	<i>Qty.</i>	<i>Description</i>
1	120-4292	1	Connecting Rod ASM	16	120-4207	1	Cover-Valve
2	120-4288	2	Ring-Retaining, Piston Pin	18	120-4345	1	Bracket-Muffler
3	120-4291	1	Pin-Piston	19	120-4209	2	Screw-Shoulder, HHF
4	120-4290	1	Piston	20	120-4307	4	Keeper-Valve
5	120-4289	1	Ring Set	21	120-4306	2	Retainer-Spring, Valve
7	120-4200	2	Pin-Dowel	22	120-4305	2	Spring-Valve
8	120-4203	1	Head-Cylinder	23	120-4304	2	Seal-Stem, Valve
9	120-4317	1	Gasket-Exhaust	24	120-4303	2	Seat-Spring, Valve
10	77-7330	1	Plug-Spark	25	120-4302	2	Valve Set
11	120-4205	4	Screw-HHF	26	120-4210	2	Screw-Shoulder, HHF
12	120-4298	2	Lifter-Valve	27	120-4201	1	Gasket-Cylinder
13	120-4340	2	Rod-Push	28	136-7888	1	Complete Head ASM
14	120-4300	1	Plate-Guide, Push Rod	98	136-7885	1	Rocker Arm Kit
15	120-4206	1	Gasket-Cover, Valve				

Blower Housing Assembly

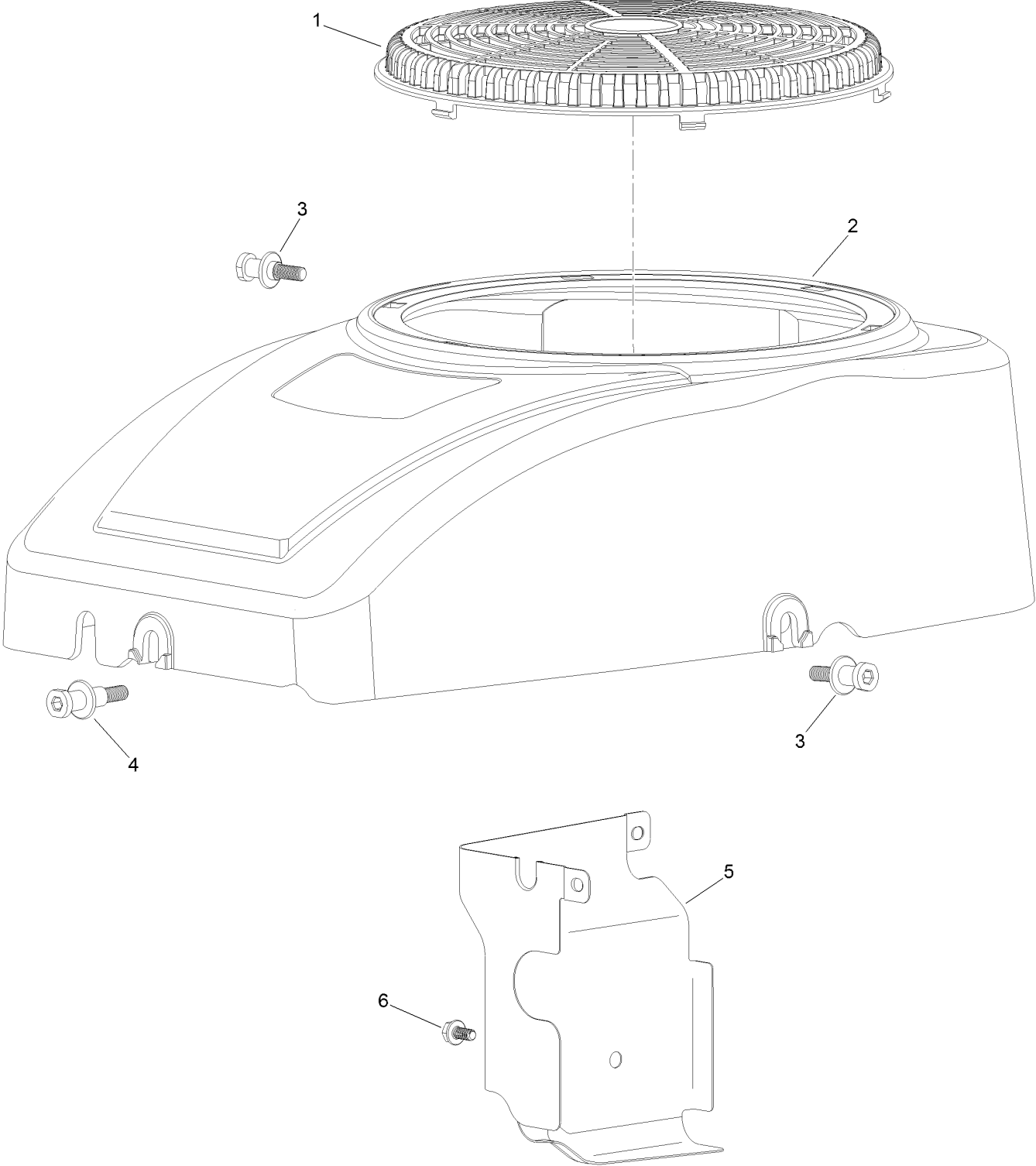

Blower Housing Assembly (continued)

<i>Ref.</i>	<i>Part Number</i>	<i>Qty.</i>	<i>Description</i>	<i>Ref.</i>	<i>Part Number</i>	<i>Qty.</i>	<i>Description</i>
1	120-4219	1	Screen-Stationary	4	120-4214	1	Screw-Shoulder, HH
2	120-4218	1	Shroud-Fan	5	120-4215	1	Shield
3	120-4217	2	Screw-Shoulder, HH	6	120-4216	1	Screw-HHF

Gasket and Seal Kit

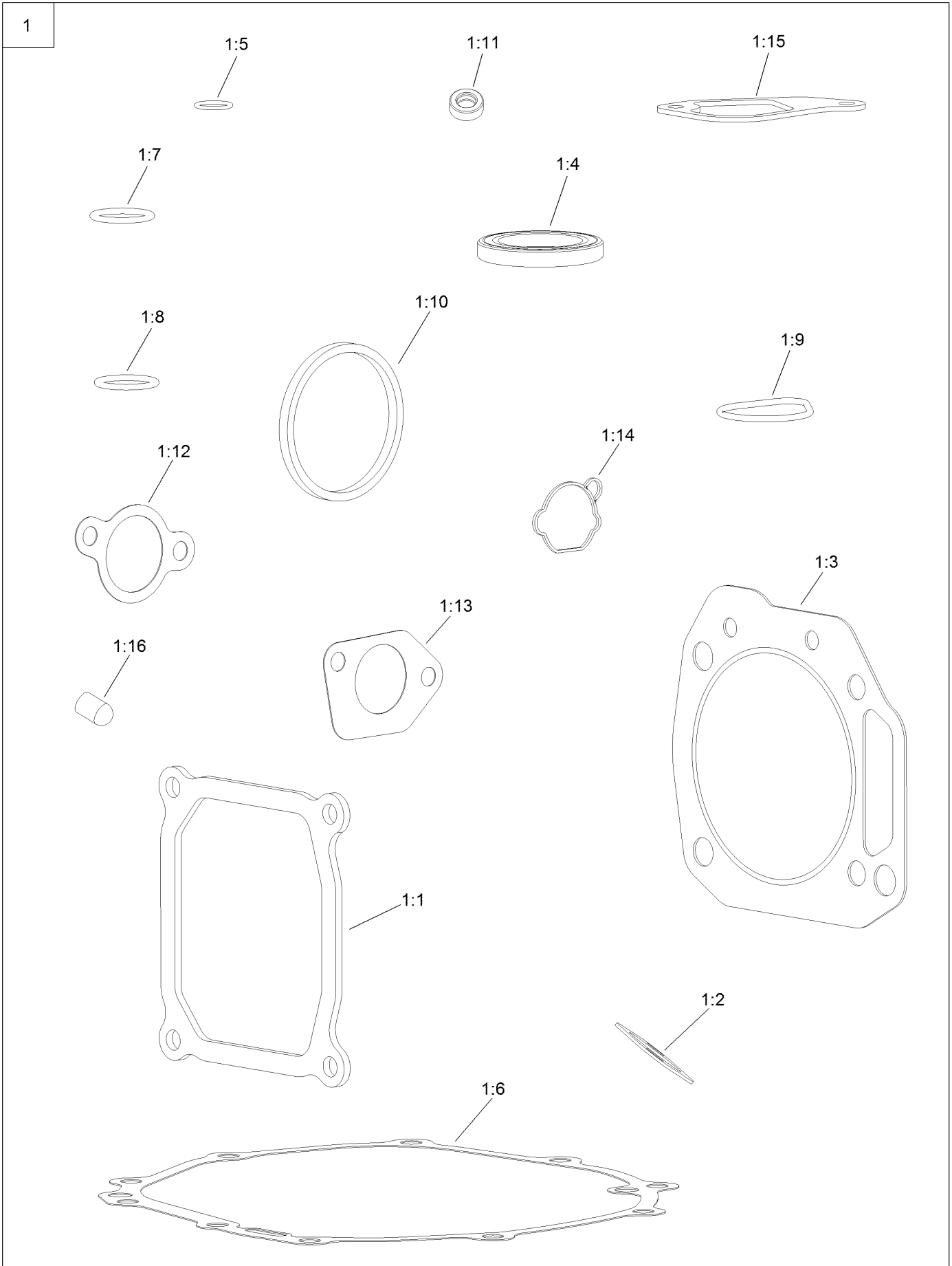

Gasket and Seal Kit (continued)

<i>Ref.</i>	<i>Part Number</i>	<i>Qty.</i>	<i>Description</i>	<i>Ref.</i>	<i>Part Number</i>	<i>Qty.</i>	<i>Description</i>
1	127-9192	1	Gasket And Seal Kit	1:9	120-4343	1	Seal-Pump, Oil
1:1	120-4206	1	Gasket-Cover, Valve	1:10	120-4362	1	Seal-Adaptor, Oil
1:2	120-4317	1	Gasket-Exhaust	1:11	120-4257	1	Seal-Oil
1:3	120-4201	1	Gasket-Cylinder	1:12	120-4250	1	Gasket-Carburetor
1:4	120-4267	2	Seal-Oil	1:13	120-4247	2	Gasket-Carburetor
1:5	120-4262	1	O-Ring	1:14	127-9185	1	Gasket-Carburetor
1:6	120-4260	1	Gasket-Crankcase	1:15	120-4264	1	Gasket-Breather
1:7	120-4348	1	O-Ring	1:16	127-9189	1	Cap-Seal
1:8	120-4282	1	O-Ring				

Attachments and Accessories

For 33522 Brush Cutter

Product Name	Model/Part
Spark Arrester Kit	131-4160
Blade-Brush.....	132-7036-03
Flail Ends Kit.....	136-4623
Flail Blade Kit.....	136-4622
Deck Ski Kit	137-7608

Notes:

Notes:

Notes:



Count on it.