

LAWN-BOY®

SilverPro Series™

Walk Power Lawn Mower

Model No. 10247—200000001 and Up

Model No. 10252—200000001 and Up

Model No. 10323—200000001 and Up

Model No. 10324—200000001 and Up

Operator's Manual

Para obtener una versión gratis de este manual en español, escriba a la dirección indicada más abajo. Asegúrese de indicar el modelo y el número de serie de su producto.

Pour obtenir gratuitement une version en français de ce manuel, écrivez à l'adresse ci-dessous. N'oubliez pas d'indiquer les numéros de modèle et de série de votre produit.

Lawn-Boy Inc., Attn.: Parts Dept., 8111 Lyndale Ave S, Bloomington, MN 55420-1196.



WARNING



The engine exhaust from this product contains chemicals known to the State of California to cause cancer, birth defects, or other reproductive harm.

IMPORTANT: This engine is not equipped with a spark arrester muffler. It is a violation of California Public Resource Code Section 4442 to use or operate this engine on any forest-covered, brush-covered or grass-covered land. Other states or federal areas may have similar laws.

This spark ignition system complies with Canadian ICES-002.

Ce système d'allumage par étincelle de véhicule est conforme à la norme NMB-002 du Canada.

The enclosed Engine Owner's Manual is supplied for information regarding The U.S. Environmental Protection Agency (EPA) and the California Emission Control Regulation of emission systems, maintenance and warranty.

Keep this engine Owner's Manual with your unit. Should this engine Owner's Manual become damaged or illegible, replace immediately. Replacements may be ordered through the engine manufacturer.

Contents

	Page
Introduction	2
Safety	3
General Lawn Mower Safety	3
Safety and Instruction Decals	6
Assembly	6
Unfolding the Handle	6
Adjusting the Handle Height	7
Before Starting	7
Mixing Gasoline and Oil	7
Operation	9
Starting the Engine	9
Stopping the Engine	9
Using the Self-propel Drive	10
Adjusting the Cutting Height	10
Operating Tips	10
Maintenance	12
Recommended Maintenance Schedule	12
Cleaning the Lawn Mower Housing	13
Cleaning the Self-propel Drive	14
Lubricating the Self-propel Drive	14
Adjusting the Self-propel Drive Cable	14

Servicing the Air Filter	15
Maintaining the Spark Plug	15
Maintaining the Blade	16
Cleaning the Exhaust Port	17
Storage	18
Preparing the Fuel System	18
Preparing the Engine	18
General Information	18
Folding the Handle	19
Removing from Storage	19
Accessories	19
Installing a Rear Grass Catcher	19
Installing the Cover Plate	22
Installing the Mulch Plate	22
Troubleshooting	24
Federal Emission Control Warranty Statement	26
The Lawn-Boy No-Worry Warranty	28

IMPORTANT: The two-stroke engine provided on this product meets the EPA Phase I Non-Road Emissions regulations for engines under 19 kW. This product does not meet CARB TIER 1 regulations and cannot be sold in California.

Introduction

Thank you for choosing a Lawn-Boy product. We want you to be completely satisfied with your new purchase.

Read this manual carefully to learn how to operate and maintain your product properly. The information in this manual can help you and others avoid injury and product damage. Although Lawn-Boy designs and produces safe products, you are responsible for operating the product properly and safely.

Whenever you contact your Authorized Service Dealer or the factory for help with service, genuine Lawn-Boy parts, or additional information, have the model number and the serial number of your product handy. You will find the model number and serial number decal on the product as illustrated in Figure 1.

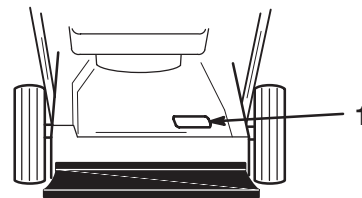

1064

Figure 1

1. Model number and serial number decal

Write the product model number and serial number in the space below:

Model No. _____

Serial No. _____

This manual identifies potential hazards and has special safety messages that help you and others avoid personal injury and even death. DANGER, WARNING, and CAUTION are words used to identify the level of hazard.

DANGER signals an extreme hazard that will cause serious injury or death if you do not follow the recommended precautions.

WARNING signals a hazard that may cause serious injury or death if you do not follow the recommended precautions.

CAUTION signals a hazard that may cause minor or moderate injury if you do not follow the recommended precautions.

This manual uses two other words to highlight information. **Important** calls attention to special mechanical information and **Note** emphasizes general information worthy of special attention.

Safety

This lawn mower meets or exceeds CPSC blade safety requirements for walk-behind rotary mowers and the B71.1 specifications of the American National Standards Institute, in effect at time of production.

Lawn-Boy designed this lawn mower for cutting and mulching grass, or, when equipped with a grass bag, for catching cut grass. Any use for purposes other than these could prove dangerous to the operator or to bystanders.

Note: The engine on this lawn mower is **not** equipped with a spark arrester muffler. Operating this lawn mower on any forest-covered, brush-covered, or unimproved grass-covered land without an approved spark arrester muffler may violate your state law.

WARNING

POTENTIAL HAZARD

- Engine exhaust contains carbon monoxide, which is an odorless, deadly poison.

WHAT CAN HAPPEN

- Carbon monoxide can kill you.

HOW TO AVOID THE HAZARD

- Do not run the engine indoors or in an enclosed area.

To ensure maximum safety, best performance, and to gain knowledge of the product, it is essential that you and any other operator of the lawn mower read and understand the contents of this manual before the motor is ever started. Pay particular attention to the safety alert symbol which means CAUTION, WARNING, OR DANGER — “personal safety instruction.” Read and understand the instruction because it has to do with safety. Failure to comply with instruction may result in personal injury.

General Lawn Mower Safety

The following instructions have been adapted from the ANSI/OPEI standard B71.1—1998 and ISO standard 5395:1990(E). Information or terminology specific to Lawn-Boy lawn mowers is enclosed in parenthesis.

This cutting machine is capable of amputating hands and feet and throwing objects. Failure to observe the following safety instructions could result in serious injury or death.

Training

- Read the instructions carefully. Be familiar with the controls and the proper use of the equipment before starting.
- See manufacturer’s instructions for proper operation and installation of accessories. Only use accessories approved by the manufacturer.
- Never allow children or people unfamiliar with these instructions to use the mower. Local regulations may restrict the age of the operator.
- Never mow while people, especially children, or pets are nearby. Stop mower if anyone enters the area.

Tragic accidents can occur if the operator is not alert to the presence of children. Children are often attracted to the mower and the mowing activity. **Never** assume that children will remain where you last saw them.

- Keep children out of the mowing area and under the watchful care of a responsible adult.
- Be alert and turn mower off if children enter the area.

- Use extra care when approaching blind corners, shrubs, trees, or other objects that may obscure vision.
- Keep in mind that the operator or user is responsible for accidents or hazards occurring to other people or their property.

Preparation

- While mowing, always wear substantial footwear and long trousers.
 - Do not operate the equipment when barefoot or wearing open sandals.
 - Always wear safety goggles or safety glasses with side shields when operating mower.
 - Thoroughly inspect the area where the equipment is to be used and remove all stones, sticks, wires, bones, and other foreign objects.
 - **Warning: Gasoline is highly flammable.** Take the following precautions:
 - Store fuel in containers specifically designed for this purpose.
 - Refuel outdoors only and do not smoke while refuelling.
 - Add fuel before starting the engine. Never remove the cap of the fuel tank or add gasoline while the engine is running or when the engine is hot.
 - If gasoline is spilled, do not attempt to start the engine but move the machine away from the area of spillage and avoid creating any source of ignition until gasoline vapors have dissipated.
 - Replace all fuel tank and container caps securely.
 - If the fuel tank has to be drained, do this outdoors.
 - Replace faulty mufflers.
 - Before using, always visually inspect to see that the blades, blade bolts, and cutter assembly are not worn or damaged. Replace worn or damaged blades and bolts in sets to preserve balance.
 - On multibladed machines, take care as rotating one blade can cause other blades to rotate.
- For wheeled rotary machines, mow across the face of slopes, never up and down.
 - Exercise extreme caution when changing direction on slopes.
 - Do not mow excessively steep slopes.
 - Use extreme caution when reversing or pulling the mower toward you.
 - Before and while moving backward, look behind and down for small children.
 - Stop the blade(s) if the mower has to be tilted for transportation when crossing surfaces other than grass and when transporting the mower to and from the area to be mowed.
 - Never operate the mower with damaged or missing guards or shields, or without safety devices; for example, deflectors and/or grass catchers in place.
 - Do not change the engine governor settings or overspeed the engine.
 - Disengage all blade and drive clutches before starting the engine.
 - Start the engine or switch on the motor carefully according to instructions and with feet well away from the blade(s).
 - Do not tilt when starting the engine or switching on the motor, unless the mower has to be tilted for starting. In this case, do not tilt it more than absolutely necessary and lift only the part which is away from the operator.
 - Do not start the engine when standing in front of the discharge chute.
 - Do not put hands or feet near or under rotating parts. Keep clear of the discharge opening at all times.
 - Never pick up or carry a mower while the engine is running.
 - Stop the engine and disconnect the spark plug lead
 - before clearing blockages or unclogging chute;
 - before checking, cleaning, or working on the mower;
 - after striking a foreign object. Inspect the mower for damage and make repairs before restarting and operating the mower;
 - if mower starts to vibrate abnormally (check immediately).
 - Stop the engine
 - whenever you leave the mower;
 - before refuelling.

Operation

- Do not operate the engine in a confined space where dangerous carbon monoxide fumes can collect.
- Mow only in daylight or in good artificial light.
- Always be sure of your footing on slopes.
- Walk; never run.
- Keep a firm hold on the handle.

- Reduce the throttle setting during engine run-out and, if the engine is provided with a shut-off valve, turn the fuel off at the conclusion of mowing.
- Stop the blade(s) when crossing gravel drives, walks, or roads.
- Shut the engine off and wait until the blade comes to complete stop before removing grass catcher.
- Do not operate the mower while under the influence of alcohol or drugs.
- If the equipment should start to vibrate abnormally, stop the engine and check immediately for the cause. Vibration is generally a warning of trouble.
- Always disconnect electric mowers (live operated) before cleaning, repairing, or adjusting.
- Grass catcher components are subject to wear, damage, and deterioration, which could expose moving parts or allow objects to be thrown. Frequently check components and replace with manufacturer's recommended parts when necessary.
- Mower blades are sharp and can cut. Wrap the blade(s) or wear gloves, and use extra caution when servicing them.
- Do not change the engine governor setting or overspeed the engine.

Slopes are a major factor related to slip and fall accidents which can result in severe injury. All slopes require extra caution feel uneasy on a slope, do not mow it.

- Watch for holes, ruts, or bumps. Tall grass can hide obstacles.
- **Do not** mow near drop-offs, ditches, or embankments. The operator could lose footing or balance.
- **Do not** mow on wet grass. Reduced footing could cause slipping.

- To ensure the best performance and safety, purchase only genuine Lawn-Boy replacement parts and accessories. **Do not use "will fit" parts and accessories; they may cause a safety hazard.**

Maintenance and Storage

- Keep all nuts, bolts (especially blade attachment bolts), and screws tight to be sure the equipment is in safe working condition.
- Never store the equipment with gasoline in the tank inside a building where fumes may reach an open flame or spark.
- Allow the engine to cool before storing in any enclosure.
- To reduce the fire hazard, keep the engine, muffler, battery compartment, and gasoline storage area free of grass, leaves, or excessive grease.
- Check the grass catcher frequently for wear or deterioration.
- Replace worn or damaged parts for safety.
- Use extra care when handling gasoline; vapors are explosive.
- Never tamper with safety devices. Check their proper operation regularly.
- Keep the mower free of grass, leaves, or other debris build-up. Clean up oil or fuel spillage.
- Stop and inspect the equipment if you strike an object. Repair, if necessary, before restarting.
- Never attempt to make wheel height adjustments while the engine is running.

Safety and Instruction Decals



Safety decals and instructions are easily visible to the operator and are located near any area of potential danger. Replace any decal that is damaged or lost.



On Mower Housing
(Part No. 43-8480)



On Mower Housing
(Part No. 99-6018)



By Front Height Adjuster
(Part No. 92-2914 Right)
(Part No. 92-2915 Left)



On Top of Grass Catcher Chute
(Part No. 92-2919)
(Model 10324)

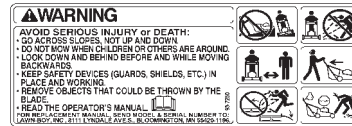

On Mower Housing
(Part No. 93-7250)

Assembly

Note: Determine the left and right sides of the lawn mower by standing in the operating position.

Unfolding the Handle

! **WARNING** !

POTENTIAL HAZARD

- Folding or unfolding the handle improperly can pinch, stretch, or damage one or more of the cables.

WHAT CAN HAPPEN

- Any pinched, stretched, or damaged cable may cause an operational failure that results in an unsafe operating condition.

HOW TO AVOID THE HAZARD

- Do not pinch, stretch, or damage the cables.
- Handle the cables with care when folding or unfolding the handle.
- Do not use the lawn mower if one or more of the cables are pinched, stretched, or damaged. Contact your Authorized Service Dealer.

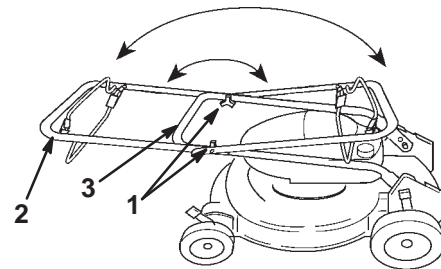

1068

Figure 2

1. Knobs
2. Upper handle section
3. Lower handle section

2. Tighten the knobs securely.
3. Rotate the handle toward the rear of the lawn mower until it snaps into the stops in the handle brackets.

Note: The traction cable may disconnect during shipping and prevent the lawn mower from self-propelling (self-propel models only). If the traction cable is disconnected, connect it (refer to Figure 16).

1. Loosen the handle knobs and lift the upper handle section in an arc until the upper and lower handle sections line up and nest together (Fig. 2).

Adjusting the Handle Height

You can set the handle to two height settings: high and low (Fig. 3). Select the handle height setting most comfortable for you.

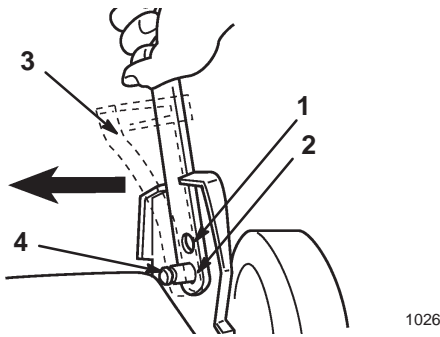

Figure 3

- | | |
|-----------------|--|
| 1. Low setting | 3. Cable anchor
(Self-propelled models) |
| 2. High setting | 4. Pin |

1. Squeeze the bottom handle section (both sides) inward off of the pins (Fig. 3).
2. Position the handle and the cable anchor (self-propelled models only) over the pins at the desired height.

Note: On self-propelled models, you may need to loosen the belt cover and move it slightly.

3. On self-propelled models, adjust the cable. Refer to Maintenance on page 12.

Before Starting

Mixing Gasoline and Oil

Your Lawn-Boy lawn mower is powered by a two-cycle engine which requires a 32:1 mixture of gasoline and oil.

Use only clean, fresh, lead-free gasoline (including oxygenated or reformulated gasoline) with an octane rating of 87 or higher. To ensure freshness, purchase only the amount of gasoline you expect to use in 30 days. Using unleaded gasoline results in fewer combustion chamber deposits and longer spark plug life.

IMPORTANT: Do not use methanol, gasoline containing methanol, gasohol containing more than 10% ethanol, premium gasoline, or white gas. Using these fuels can damage the engine's fuel system.

IMPORTANT: Do not use automotive oil (i.e., SAE 30 or 10W30), a two-cycle oil that is not NMMA TCW III-certified, or a fuel mixed at the wrong gasoline/oil ratio. This can cause engine damage not covered under the Lawn-Boy warranty.



DANGER



POTENTIAL HAZARD

- In certain conditions, gasoline is extremely flammable and highly explosive.

WHAT CAN HAPPEN

- A fire or explosion from gasoline can burn you and others and can damage property.

HOW TO AVOID THE HAZARD

- Fill the fuel tank outdoors, in an open area, and when the engine is cold. Wipe up any gasoline that spills.
- Do not fill the fuel tank completely full. Add gasoline to the fuel tank until the level is 1/4 to 1/2 in. (6 to 13 mm) below the bottom of the filler neck. This empty space in the tank allows gasoline to expand.
- Never smoke when handling gasoline, and stay away from an open flame or where a spark may ignite the gasoline fumes.
- Store gasoline in an approved container and keep it out of the reach of children.
- Never buy more than a 30-day supply of gasoline.



DANGER



POTENTIAL HAZARD

- When fueling, under certain circumstances, a static charge can develop, igniting the gasoline.

WHAT CAN HAPPEN

- A fire or explosion from gasoline can burn you and others and cause property damage.

HOW TO AVOID THE HAZARD

- Always place gasoline containers on the ground away from your vehicle before filling.
- Do not fill gasoline containers inside a vehicle or on a truck or trailer bed because interior carpets or plastic truck bed liners may insulate the container and slow the loss of any static charge.
- When practical, remove gas-powered equipment from the truck or trailer and refuel the equipment with its wheels on the ground.
- If this is not possible, refuel such equipment on a truck or trailer from a portable container, rather than from a gasoline dispenser nozzle.
- If a gasoline dispenser nozzle must be used, keep the nozzle in contact with the rim of the fuel tank or container opening at all times until fueling is complete.

Use only *Lawn-Boy Generation II 2-Cycle Oil* (Fig. 4) or an equivalent premium grade, NMMA TCW III-certified two-cycle ashless oil.



Figure 4

Lawn-Boy Generation II 2-Cycle Oil is formulated specifically for Lawn-Boy two-cycle engines and is available from your Lawn-Boy retailer. Using Lawn-Boy Generation II 2-Cycle Oil regularly will help keep your engine clean, reduce spark plug fouling, piston ring sticking, and pre-ignition. It also minimizes varnish buildup, combustion chamber deposits, and exhaust port blockage.

Substitute oils may produce more exhaust smoke, require more frequent engine service, and reduce engine life.

Note: Failing to use the proper oil or the 32:1 gasoline-to-oil mixture ratio can result in serious engine damage.

Add Lawn-Boy Generation II 2-Cycle Oil (Fig. 4) or an equivalent oil to fresh, unleaded gasoline according to the chart below:

32:1 Gasoline-to-Oil Ratio Mixing Chart	
Gasoline	Oil
1 gallon (3.8 liters)	4 ounces (118 ml)
2 gallons (7.6 liters)	8 ounces (237 ml)
5 gallons (19 liters)	20 ounces (591 ml)

To properly mix the gasoline and oil:

1. Pour half of the desired amount of fresh, unleaded gasoline into a clean, approved gasoline container.
2. Add the full amount of Lawn-Boy Generation II 2-Cycle Oil (Fig. 4) or an equivalent oil to the gasoline.
3. Install the cap on the gasoline container.
4. Shake the gasoline-and-oil mixture thoroughly.

5. Slowly remove the cap and add the remaining amount of gasoline.

Note: Do not mix gasoline and oil in the fuel tank. Oil at room temperature mixes easier and more thoroughly than cold oil. Oil below 32°F (0°C) requires additional mixing.

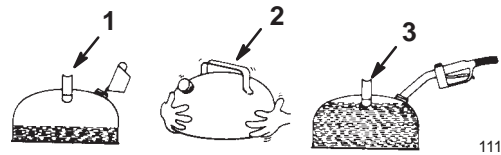

Figure 5

1. Add oil to half of the gasoline
2. Install the cap and shake the can to mix
3. Add the remaining amount of gasoline

IMPORTANT: Do not overfill the fuel tank. The gasoline/oil mix must have room to expand.

IMPORTANT: Do not use fuel additives except a fuel stabilizer during storage. Do not use fuel stabilizers with an alcohol base such as ethanol, methanol, or isopropanol. You do not need a stabilizer if you use Lawn-Boy Generation II 2-Cycle Oil (Fig. 4).

6. Clean around the fuel cap (Fig. 6).

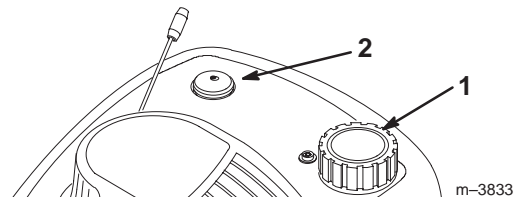

Figure 6

1. Fuel cap
2. Primer

7. Remove the fuel cap and fill the fuel tank with the gasoline-and-oil mixture to within 1/4 inch (6 mm) from the top of the tank. **Do not fill into the filler neck.**

8. Install the fuel cap securely and wipe up any spilled fuel.

Operation

Starting the Engine

1. Ensure that the wire is connected to the spark plug (Fig. 7).

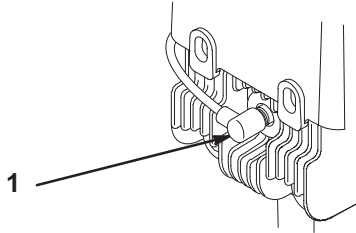

Figure 7

m-3884

1. Spark plug wire

2. When starting a cold engine, move the throttle lever to the *Choke* position (Fig. 8).

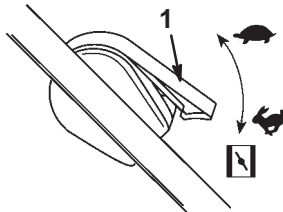

Figure 8

1019

1. Throttle lever

3. Push the primer three times (Fig. 6). Wait about two seconds between each push.

Note: To start a warm engine, move the throttle level to the *Fast* position and press the primer no more than once.

4. Hold the blade control bail against the upper handle (Fig. 9).

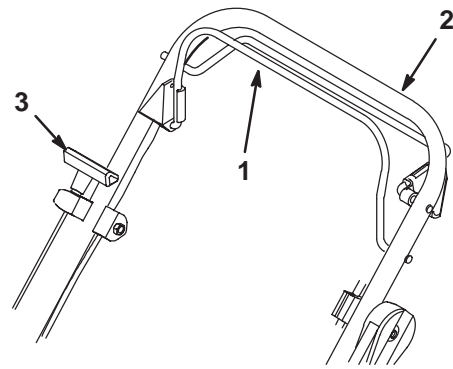

Figure 9

982

1. Blade control bail
2. Upper handle
3. Starter handle

5. Pull the starter handle lightly until you feel resistance, then pull it sharply (Fig. 9). Let the rope return to the handle slowly.

6. If the engine fails to start, repeat steps 3 through 5.

Stopping the Engine

1. Move throttle lever to the *Slow* position (Fig. 8).
2. Release the blade control bail (Fig. 10). Both the engine and the blade will stop. Contact your Authorized Service Dealer immediately if they do not.

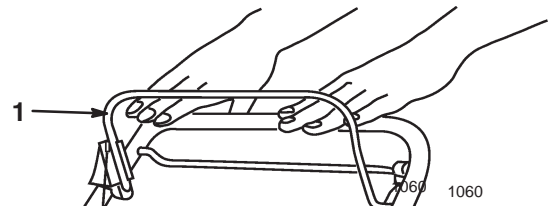

Figure 10

1060

1. Blade control bail

Using the Self-propel Drive

Self-propel Models only

1. To operate the self-propel drive, squeeze the self-propel drive bail against the handle and hold it (Fig. 11).

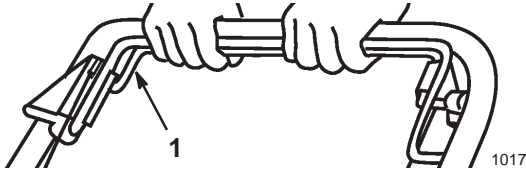

Figure 11

1. Self-propel drive bail

Note: The maximum self-propel drive speed is fixed. To reduce the speed, increase the space between the bail and the handle.

2. To disengage the self-propel drive, release the self-propel drive bail (Fig. 12).

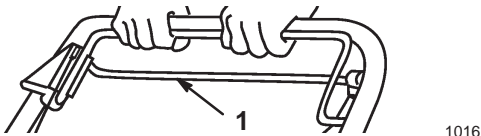

Figure 12

1. Self-propel drive bail

Note: The lawn mower comes with free-wheeling clutches which make it easier to pull the lawn mower rearward. To disengage the clutches, you may need to push the lawn mower forward one inch (2.5 cm) or more after you release the self-propel drive bail.

Adjusting the Cutting Height

You can adjust each wheel individually with a wheel height adjustment lever. Cutting heights are 1 in. (25 mm); 1-1/2 in. (38 mm); 2 in. (51 mm); 2-1/2 in. (64 mm); 3 in. (76 mm); and 3-1/2 in. (89 mm).



DANGER



POTENTIAL HAZARD

- Adjusting the height-of-cut levers could bring your hands into contact with a moving blade.

WHAT CAN HAPPEN

- Contact with a rotating blade can cause serious injury.

HOW TO AVOID THE HAZARD

- Stop the engine and wait for all movement to stop before adjusting the cutting height.
- Do not put fingers under the housing when adjusting the cutting height.

1. Pull the adjusting lever toward the wheel and move it to the desired position (Fig. 13).

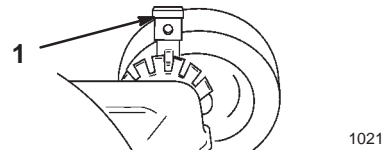

Figure 13



1. Wheel height adjustment lever

2. Release the height adjust lever and seat it securely in the desired notch.

Note: Set all four wheels to the same height.

Operating Tips

- Review the safety instructions and read this manual carefully before operating the lawn mower.
- Clear the area of sticks, stones, wire, branches, and other debris that the lawn mower could pick up or the blade could hit and throw objects.
- Keep everyone, especially children and pets, away from the area of operation.
- Avoid striking trees, walls, curbs, or other solid objects. Never deliberately mow over any object.
- If the lawn mower strikes an object or starts to vibrate, immediately stop the engine, disconnect the spark plug wire, and examine the lawn mower for damage.
- Maintain a **sharp blade** throughout the cutting season. Periodically file down nicks on the blade.
- Replace the blade when necessary with an original Lawn-Boy replacement blade.
- Mow only dry grass or leaves. Wet grass and leaves tend to clump on the yard and may cause the lawn mower to plug or the engine to stall.

 **WARNING** 

POTENTIAL HAZARD

- **Wet grass or leaves can cause you to slip and contact the blade.**



WHAT CAN HAPPEN

- **Blade contact can seriously injure you.**

HOW TO AVOID THE HAZARD

- **Mow only in dry conditions.**

- Clean clippings or leaves from the underside of the lawn mower deck after each mowing. See Cleaning the Lawn Mower Housing on page 13.
- Keep the engine in good running condition.

 **WARNING** 

POTENTIAL HAZARD

- **Operating a lawn mower with its engine running at a speed greater than the factory setting can cause an unsafe operating condition.**

WHAT CAN HAPPEN

- **The lawn mower could throw a part of the blade or engine into the operator's or bystander's area and cause serious personal injury or death.**

HOW TO AVOID THE HAZARD

- **Do not change the engine speed setting.**
- **If you suspect the engine speed is faster than normal, contact your Authorized Service Dealer.**

- Clean the air filter frequently. Mulching stirs up more clippings and dust which clogs the air filter and reduces engine performance.
- To achieve the best mulching action, set the lawn mower cutting height so that the lawn mower cuts no more than a third of the grass stem or a maximum of one-inch (25 mm) long clippings. If you try to mulch more or if the grass is very lush, the mulching action will be poor. Under these conditions, use the side discharge or grass catcher. A few days later, install the mulch plate on your lawn mower to resume mulching.

Cutting Grass

- In the summer heat, cut the grass at the 2, 2-1/2, or 3-inch (51, 64, or 76 mm) cutting height-settings. Only cut off about one-third of the grass blade. Do not cut below the two-inch setting unless the grass is sparse or it is late autumn when the grass growth begins to slow down.

- When cutting grass over six inches tall, first mow using the highest cutting height setting and walking slower; then mow again at a lower setting for best lawn appearance. If the grass is too long and leaves clumps on top of the lawn, the lawn mower may plug up and cause the engine to stall.
- Alternate the mowing direction. This helps disperse the clippings over the lawn for even fertilization.

If the finished cut lawn appearance is unsatisfactory, try one or more of the following:

- Sharpen the blade.
- Walk at a slower pace while mowing.
- Raise the cutting height on your lawn mower.
- Cut the grass more frequently.
- Overlap the cutting swaths instead of cutting a full swath with each pass.
- Set the cutting height on the front wheels one notch lower than the rear wheels.

Cutting Leaves

- After cutting the lawn, make sure that half of the lawn shows through the cut leaf cover. You may need to make one or more passes over the leaves.
- For light leaf coverage, set all the wheels at the same cutting height.
- If there are more than 5 inches (12.7 cm) of leaves on the lawn, set the front wheels one or two notches higher than the rear wheels. This makes it easier to feed the leaves under the lawn mower deck.
- Slow down your mowing speed if the lawn mower does not cut the leaves finely enough.
- If you mow over oak leaves, you can add lime to the grass in the spring to reduce the acidity of the leaves.

Maintenance

NOTICE: To obtain repairs at no charge under the terms and provisions of the Lawn-Boy warranty statement, an Authorized Service Dealer must perform the service or emission control part repair or replacement.

Recommended Maintenance Schedule

Service Item	Service Operation	Each Use	25 Hours	50 Hours	100 Hours
Blade Brake	Check the stopping time before each use. The blade must stop within three seconds of releasing the bail; if it does not, contact your Authorized Service Dealer for repair.	X			
Housing	Clean off built-up grass clippings and dirt from the housing after each use.	X			
Fasteners	Check the blade and the engine mounting fasteners. Keep all nuts, bolts, and screws tight to ensure safe operation.		X		
Self-propel Drive	Clean the grass clippings and debris under the belt cover and near the drive belt (self-propelled models).		X		
	Grease the rear height adjustor brackets (self-propel models).		X		
	Adjust the self-propel drive after changing the handle height, installing a new self-propel drive cable, or if the traction drive belt slips.			X	
Air Filter	Remove and clean the air filter each mowing season or every 50 hours. Clean the air filter more frequently in dusty operating conditions.			X	
Spark Plug	Clean, inspect, and gap the spark plug. Replace it if necessary.			X	
Blade	Sharpen or replace the blade; maintain the blade more frequently if the edge dulls quickly in rough or sandy conditions.			X	
Fuel System	Check the fuel system for leaks and/or a deteriorating fuel hose. Replace parts if necessary.			X	
Exhaust Port	Clean the exhaust port.				X
Cooling System	Clean off grass clippings, debris, or dirt that can clog the engine air cooling fins and starter. Clean the cooling system more frequently in dirty operating conditions.				X



CAUTION



POTENTIAL HAZARD

- If you leave the wire on the spark plug, someone could start the engine.

WHAT CAN HAPPEN

- Someone accidentally starting the engine could seriously injure you or other bystanders.

HOW TO AVOID THE HAZARD

- Disconnect the wire from the spark plug before you do any maintenance. Set the wire aside so it does not accidentally contact spark plug.

Cleaning the Lawn Mower Housing

A clean lawn mower housing provides the best cutting performance. Check for grass buildup and clean it after each use.

Washing Method

1. Move the lawn mower to a flat concrete or asphalt surface near a garden hose.
2. Start the engine.
3. Hold the running garden hose at handle level and direct the water to flow on the ground just in front of the right rear tire (Fig. 14).

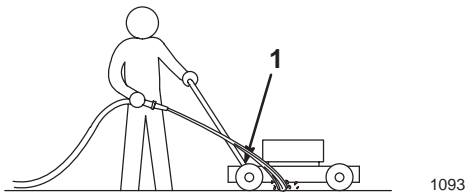

Figure 14

1. Rear right wheel

The blade will draw in water and wash out clippings. Let the water run until the clippings no longer come out from under the housing.

4. Stop the engine and wait for all moving parts to stop.
5. Turn off the garden hose.
6. Start the lawn mower and let it run for a few minutes to dry out the moisture on the lawn mower and its components.
7. While the engine runs, engage and disengage the traction drive several times to dry it out.

Scraping Method

If washing does not remove all debris from under the lawn mower, tip it and scrape it clean.

1. Run the engine dry or remove the fuel when the engine is cool.



WARNING



POTENTIAL HAZARD

- Gasoline is extremely flammable, highly explosive and under certain conditions can cause personal injury or property damage.

WHAT CAN HAPPEN

- Tipping the lawn mower may cause fuel leakage from carburetor or fuel tank.

HOW TO AVOID THE HAZARD

- Avoid fuel spills by running the engine dry or removing the gasoline with a hand pump; never siphon.

2. Disconnect the wire from the spark plug (Fig. 7).
3. Tip the lawn mower onto its right side (Fig. 15).

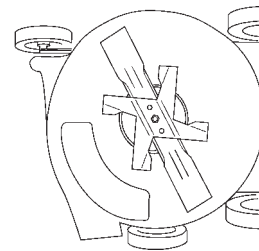

Figure 15

1036

Note: When you tip the lawn mower onto its side, rotate the blade as little as possible to avoid starting problems.

4. Scrape the built-up grass clippings and dirt from the lawn mower housing with a hardwood scraper.
5. Tip the lawn mower upright.
6. Connect the wire to the spark plug.

Cleaning the Self-propel Drive

Self-propel Models only

Under certain conditions, the clippings can collect under the belt drive cover and in the pulley groove. This can cause the belt to slip, the self-propel drive to lose power, or the self-propel drive not to disengage.

Clean the grass clippings and debris from under the belt cover every 25 hours of operation.

1. Remove the screw from the belt cover (Fig. 16).

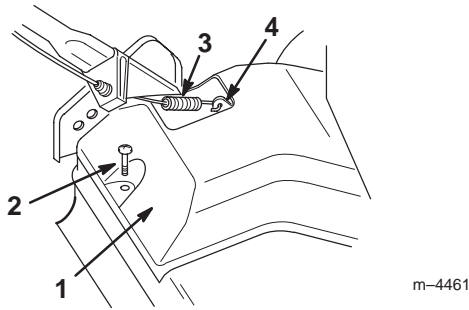

Figure 16

- | | |
|---------------|------------------|
| 1. Belt cover | 3. Cable spring |
| 2. Screw | 4. Drive bracket |

2. Unhook the cable spring from the drive bracket (Fig. 16).
3. Remove the belt cover by pulling it straight out from the engine.

Note: If the belt cover is pinched between the handle and handle bracket, remove the handle before removing the belt cover. For more information, refer to Adjusting the Handle Height on page 7.

4. Remove the debris from under the cover and the pulley groove.
5. Replace the belt cover by squeezing the sides together and inserting the tabs on the belt cover into the brackets on the engine base (Fig. 17).

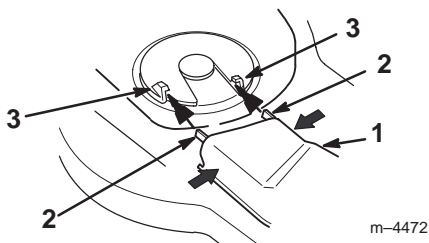

Figure 17

- | | |
|---------------|------------|
| 1. Belt cover | 3. Bracket |
| 2. Tab | |

6. Secure the belt cover with the screw.

7. Hook the cable spring onto the drive bracket.

Lubricating the Self-propel Drive

Self-propel Models only

1. Wipe the grease fittings on the rear height-of-cut adjusters (Fig. 18) with a clean rag.

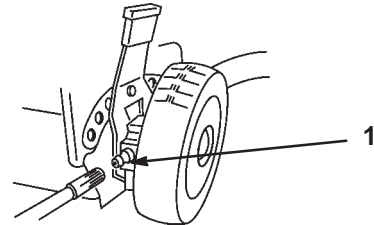

Figure 18

1. Grease fittings

2. Install a grease gun onto each fitting and gently apply one or two pumps of #2 multi-purpose lithium grease to each.

IMPORTANT: Excess grease may prevent the wheel clutch from properly operating.

Adjusting the Self-propel Drive Cable

Self-propel Models only

Whenever you change the handle height, install a new self-propel drive cable, or if the traction drive belt slips, adjust the self-propel drive cable.

Adjust the self-propel drive cable on the handle by moving the cable jacket held by the cable support.

1. Loosen the nut on the cable support (Fig. 19).

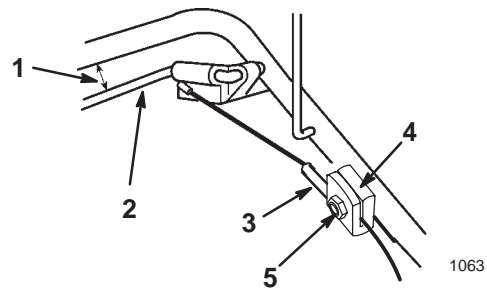

Figure 19

- | | |
|---------------------------------|------------------|
| 1. 1 to 1 1/2 in. (25 to 38 mm) | 4. Cable support |
| 2. Self-propel drive bail | 5. Nut |
| 3. Cable jacket | |

2. Hold the self-propel drive bail 1 to 1-1/2 in. (25 to 38 mm) from the handle (Fig. 19).
3. Pull the cable jacket down (away from the bail) to remove the slack in the cable between the bail and the cable support.
4. Tighten the nut on the cable support.
5. Release the bail and ensure that the cable is loose.

Note: The cable must be loose when you release the bail or the lawn mower may creep when you disengage the bail.

Servicing the Air Filter

Clean the air filter once every season or every 50 hours; **clean it more frequently under dusty conditions.**

Note: Do not operate the engine without the air filter element; extreme engine damage will occur.

1. Snap the air filter cover latch open and swing it to the side (Fig. 20).

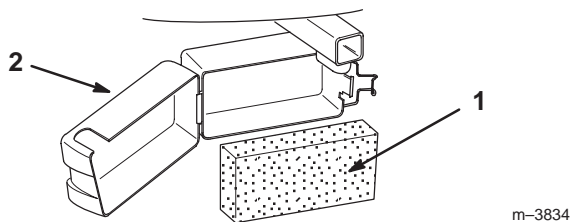

Figure 20

1. Filter
2. Cover

2. Remove the air filter.
3. Wash the air filter in laundry detergent or kerosene (Fig. 21).

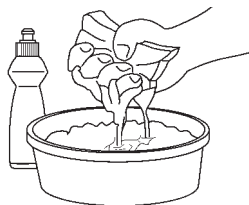

Figure 21

4. Squeeze the filter to remove excess liquid and blot it dry with a paper towel or rag.
5. Saturate the air filter with *SAE 30W* oil (Fig. 22).

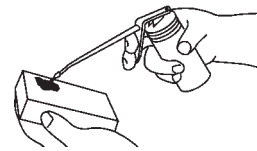

Figure 22

6. Squeeze the filter to distribute the oil evenly. Blot the filter lightly with a paper towel to remove excess oil.
7. Replace the filter with the cleanest side facing the carburetor.

Note: Ensure that the filter fully seats in the air box and does not pucker, allowing air and dirt to pass directly through to the carburetor.

Maintaining the Spark Plug

A spark plug that is dirty, pitted, carbon-covered, or has worn electrodes may cause hard starting and poor operation.

Clean or replace the spark plug once a season or every 50 hours, whichever occurs first. Use an *NGK BPR4A* spark plug.

1. Disconnect the wire from the spark plug (Fig. 7).
2. Remove the spark plug and clean it with a wire brush, removing carbon buildup.

IMPORTANT: Do not sandblast the spark plug.

3. Check the condition of the plug for cracks and damaged or worn electrodes. Replace it if necessary.
4. Set the spark plug gap at 0.035 in. (0.9 mm) (Fig. 23).

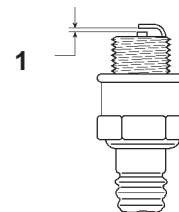

Figure 23

1. 0.035 in. (0.9 mm)

5. Install the spark plug by hand, then torque it to 180 in-lb (15 ft-lb or 20 N·m).
6. Connect the wire to the spark plug.

Maintaining the Blade

A straight, sharp blade provides maximum cutting performance. Regularly inspect and sharpen the blade.

WARNING

POTENTIAL HAZARD

- The blade is sharp.

WHAT CAN HAPPEN

- Contact with the sharp blade can cause serious personal injury.

HOW TO AVOID THE HAZARD

- Wear gloves or wrap the sharp edges of the blade with a rag.

1. Disconnect the wire from the spark plug (Fig. 7).
2. Tip the lawn mower onto its right side (Fig. 15).

Inspecting the Blade

Carefully examine the blade for sharpness and wear, especially where the flat and the curved parts meet (Fig. 24A). Because sand and abrasive material can wear away the metal that connects the flat and curved parts of the blade, check the blade before using the lawn mower. If you notice a slot or wear (Figs. 24B and 24C), replace the blade; refer to Removing the Blade on page 16.

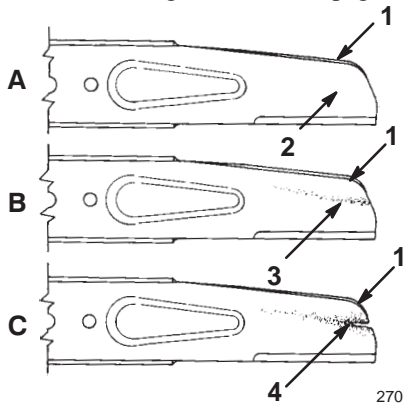

Figure 24

- | | |
|-----------------------|----------------|
| 1. Sail | 3. Wear |
| 2. Flat part of blade | 4. Slot formed |

Note: For the best performance, install a new blade before the cutting season begins. During the year, file down any small nicks to maintain the cutting edge.

DANGER

POTENTIAL HAZARD

- A worn or damaged blade could break and a piece of the blade could be thrown into the operator's or bystander's area.

WHAT CAN HAPPEN

- A thrown piece of the blade could cause serious personal injury or death to the operator or bystanders.

HOW TO AVOID THE HAZARD

- Inspect the blade periodically for wear or damage.
- Replace a worn or damaged blade.

Removing the Blade

1. Remove the blade nut and the mulching fan (Fig. 25).

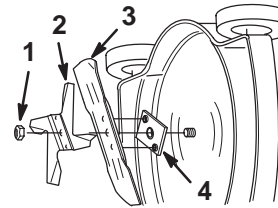

M-2909

Figure 25

- | | |
|-----------------|-----------------|
| 1. Blade nut | 3. Blade |
| 2. Mulching fan | 4. Blade driver |

2. Remove the blade from the blade driver (Fig. 25).
3. Examine the mulch fan for worn or bent blades. Replace it if necessary.
4. Examine the blade driver for bent or sheared drive lugs. Replace it if necessary.

Sharpening the Blade

File the top side of the blade to maintain its original cutting angle (Fig. 26A) and inner cutting edge radius (Fig. 26B).

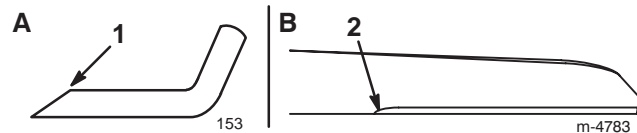

Figure 26

- | | |
|-------------------------------|--------------------------------------|
| 1. Sharpen at this angle only | 2. Maintain the original radius here |
|-------------------------------|--------------------------------------|

Note: The blade will remain balanced if you remove the same amount of material from both cutting edges.

Note: Do not grind the blade more than 5 in. (127 mm) from the outside ends and no less than 2 in. (51 mm) from the trailing edge (Fig. 27).

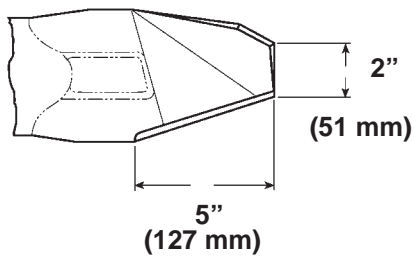

Figure 27

990

Balancing the Blade

1. Check the balance of the blade by placing the center hole of the blade over a nail or a screwdriver shank clamped horizontally in a vise (Fig. 28).

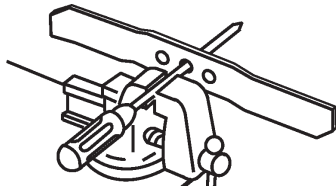

Figure 28

1007

Note: You can also check the balance by using a commercially manufactured blade balancer.

2. If either end of the blade rotates downward, file that end (not the cutting edge or the end near the cutting edge). The blade is properly balanced when neither end drops.

Installing the Blade

1. Ensure that the blade driver is installed on the crankshaft. See Figure 25.
2. Install the blade over the lugs of the blade driver with the curved ends toward the housing (Fig. 25).
3. Install the mulch fan into the blade recess (Fig. 25).
4. Secure the blade with the blade nut (Fig. 25).
5. Torque the blade nut to 47 ft-lb (63 N·m).

Note: Replace the blade nut after installing and removing the blade four times. The blade nut's locking power diminishes and the blade nut could loosen if you do not replace it.

6. Connect the wire to the spark plug.

Cleaning the Exhaust Port

Carbon deposit build-up causes excessive wear and loss of power. Check and clean the exhaust port every 100 hours.

1. Disconnect the wire from the spark plug (Fig. 7).
2. Drain the fuel from the fuel tank.
3. Tip the lawn mower onto its right side.

⚠
WARNING
⚠

POTENTIAL HAZARD

- Gasoline is extremely flammable, highly explosive and under certain conditions can cause personal injury or property damage.

WHAT CAN HAPPEN

- Tipping the lawn mower may cause fuel leakage from the carburetor or fuel tank.

HOW TO AVOID THE HAZARD

- Avoid fuel spills by running the engine dry or removing the gas with hand pump; never siphon.

4. Remove the blade nut, mulch fan, and blade. Refer to Removing the Blade on page 16.
5. Remove the four capscrews that attach the cover plate to the engine mounting plate (Fig. 29).

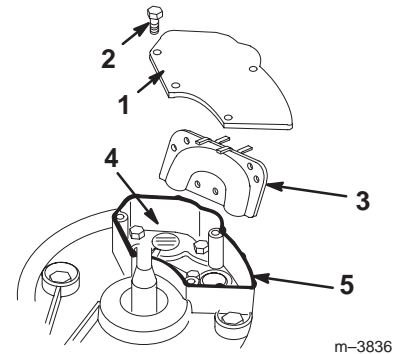

Figure 29

m-3836

- | | |
|------------------|--------------------------------------|
| 1. Cover plate | 4. Exhaust port |
| 2. Cap screw | 5. High temperature silicone sealant |
| 3. Transfer pipe | |

6. Remove the transfer pipe (Fig. 29).
7. Inspect the transfer pipe and clean it if it is dirty.
8. Rotate the crankshaft slowly until the piston covers the exhaust port (Fig. 29).
9. Using a wooden dowel, loosen the carbon deposits by inserting the dowel into the exhaust port.

Note: Do not use metal tools; they can scratch the piston.

10. Set the lawn mower upright.
11. Hold the blade control bail against the upper handle (Fig. 30) and pull the starter rope several times to blow out any loose carbon.

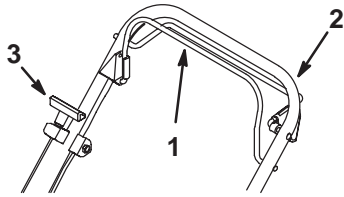

Figure 30

1. Blade control bail
2. Upper handle
3. Starter handle

12. Wipe the bottom of the cover plate and the edge of the engine mounting plate where the sealant will go with a clean cloth to remove any dirt (Fig. 29).
13. Run a bead of high-temperature automotive silicone sealant along the edge of the engine mounting plate where the cover plate will rest (Fig. 29).
14. Install the transfer pipe and cover plate (Fig. 29), torquing the four cap screws to 75 in-lb (8.5 N·m).
15. Install the blade driver, blade, and mulch fan with the blade nut. Refer to the Installing the Blade on page 17.
16. Torque the blade nut to 560 in-lb (47 ft-lb or 63 N·m).
17. Tip the lawn mower upright.
18. Connect the wire to the spark plug.

Storage

To prepare the lawn mower for off-season storage, perform the recommended maintenance procedures. Refer to Maintenance on page 12.

Store the lawn mower in a cool, dry place. Cover the lawn mower to keep it clean and protected.

Preparing the Fuel System



WARNING



POTENTIAL HAZARD

- Gasoline can vaporize if you store it over long periods of time.

WHAT CAN HAPPEN

- Vaporized gasoline can explode if it comes into contact with an open flame.

HOW TO AVOID THE HAZARD

- Do not store gasoline over long periods of time.
- Do not store the lawn mower with gasoline in the fuel tank or the carburetor in an enclosure with an open flame. (For example, a furnace or a water heater pilot light.)
- Allow the engine to cool before storing it in any enclosure.

1. Empty the fuel tank using a hand-type siphon only.
2. Run the lawn mower until the engine stops from running out of fuel.
3. Prime the engine and start it again.
4. Allow the engine to run until it stops. When you can no longer start the engine, it is sufficiently dry.

Preparing the Engine

1. Remove the spark plug.
2. Using an oil can, add about one tablespoon of oil to the engine through the spark plug hole (Fig. 31).

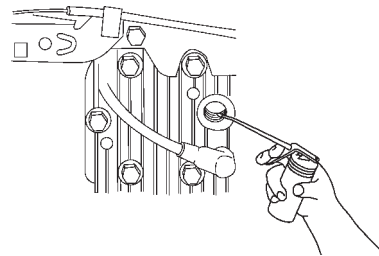

Figure 31

3. Slowly rotate the engine several times, using the starter rope, to distribute the oil.
4. Install the spark plug but **do not** connect the wire to the spark plug.

General Information

1. Clean the lawn mower housing. Refer to Cleaning the Lawn Mower Housing on page 13.

2. Clean any dirt and chaff from the cylinder, cylinder head fins, and blower housing.
3. Remove grass clippings, dirt, and grime from the external parts of the engine, the shrouding, and the top of the lawn mower housing.
4. Check the condition of the blade. Refer to Maintaining the Blade on page 16.
5. Tighten all nuts, bolts, and screws.
6. Lubricate the wheels. Refer to Lubricating the Self-propel Drive on page 14.
7. Touch up all rusted or chipped paint surfaces with paint available from an Authorized Service Dealer.

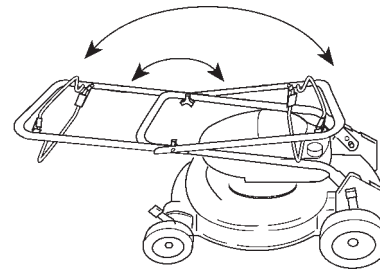

1068

Figure 33

3. Loosen the knobs that secure the upper handle section to the bottom section and fold the top handle section back toward the rear of the lawn mower into the storage position (Fig. 33).

Folding the Handle

! **WARNING** !

POTENTIAL HAZARD

- Folding or unfolding the handle improperly can pinch, stretch, or damage one or more of the cables.

WHAT CAN HAPPEN

- Any pinched, stretched, or damaged cable may cause an operational failure that results in an unsafe operating condition.

HOW TO AVOID THE HAZARD

- Do not pinch, stretch, or damage the cables.
- Handle the cables with care when folding or unfolding the handle.
- Do not use the lawn mower if one or more of the cables are pinched, stretched, or damaged. Contact your Authorized Service Dealer.

1. Squeeze the bottom handle sections together and slide them past the stops on the handle brackets (Fig. 32).

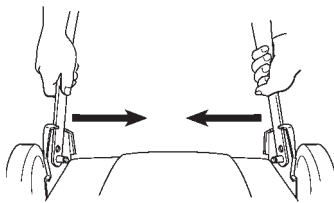

1039

Figure 32

2. Rotate the handle toward the front of the lawn mower (Fig. 33).

Removing from Storage

1. Carefully unfold the handle. Refer to Unfolding the Handle on page 6.
2. Check and tighten all fasteners.
3. Remove the spark plug and spin the engine rapidly using the starter to blow excess oil from the cylinder.
4. Clean the spark plug or replace it if it is cracked, broken, or if the electrodes are worn.
5. Install the spark plug and torque it to 180 in-lb (15 ft-lb or 20 N·m).
6. Perform the recommended maintenance procedures. Refer to Maintenance on page 12.
7. Fill the fuel tank with a fresh, clean gasoline/oil mix.
8. Connect the wire to the spark plug (Fig. 7).

Accessories

Your lawn mower may include accessories available from your Authorized Service Dealer. For proper installation of these accessories, follow these instructions.

Installing a Rear Grass Catcher

Models 10247, 10323, and 10324 only

1. Stop the engine and wait for all moving parts to stop.
2. Disconnect the wire from the spark plug (Fig. 7).
3. Remove the wing screw that fastens the cover plate to the housing (Fig. 34).

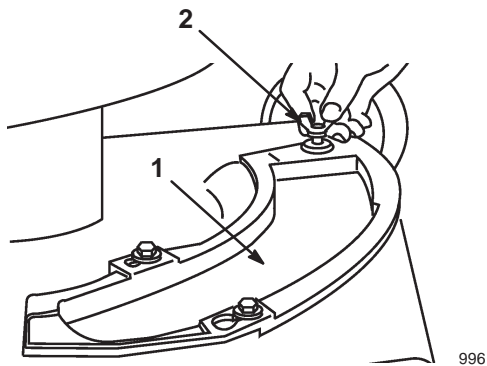

Figure 34

1. Cover or mulch plate 2. Wing screw

4. Slide the cover plate counterclockwise and remove it from the lawn mower housing.
5. Place the front corner of the chute baffle into the deck opening.
6. Rotate the chute counterclockwise and push it down into the deck opening (Fig. 35).

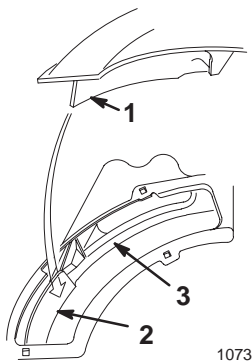

Figure 35

1. Chute baffle 3. Toe guard
2. Deck baffle

Note: The chute baffle must go behind the front deck baffle and between the blade and toe guard to prevent it from contacting the blade.

7. Insert the chute support rod through the hole in the right side of the deck (Fig. 36).

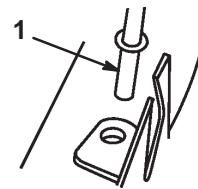

Figure 36

1. Chute support rod

8. Push the key hole slots on the chute down over the two shoulder bolts on the lawn mower housing, and slide the chute clockwise to lock it in place.
9. Secure the chute assembly with the wing screw (Fig. 37).

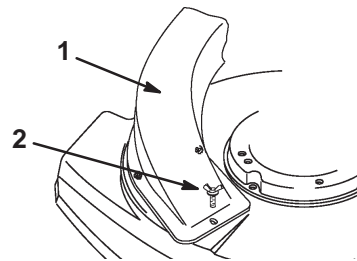

Figure 37

1. Chute assembly 2. Wing screw

10. Check the clearance between the blade tips and the baffle, ensuring that there is no contact (Fig. 38).

Note: The baffle must go behind the front deck baffle and between the blade and toe guard to prevent contact with the blade (Fig. 38).

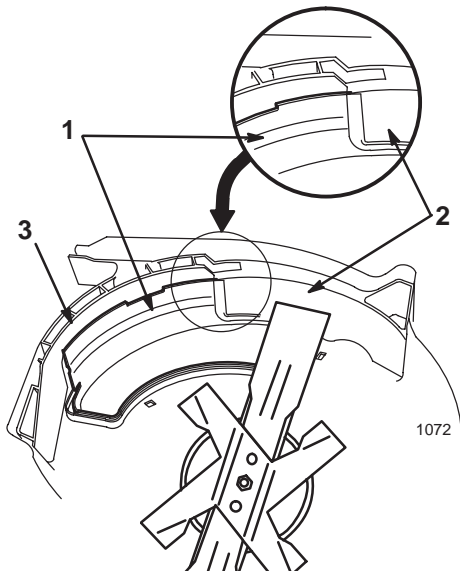

Figure 38

- | | |
|----------------------|--------------|
| 1. Baffle | 3. Toe guard |
| 2. Front deck baffle | |

11. Remove the knob and bolt that secure the left side of the upper and lower handle sections (Fig. 39).

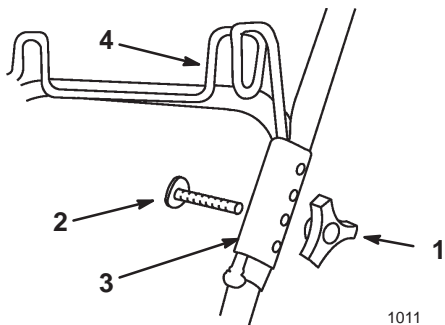

Figure 39

- | | |
|---------|-----------------|
| 1. Knob | 3. Hanger clamp |
| 2. Bolt | 4. Bag hanger |

12. Hold a hanger clamp on the outside of the handle sections, and insert a bolt from the inside of the handle sections through the holes in the hanger clamp (Fig. 39).

13. Position the bag hanger leg into the hanger clamp groove and secure it with a knob (Fig. 39).

14. Repeat steps 11 through 13 for the other side.

15. Close the rear of the bag by folding the sides in and pressing the interlocking rear handle halves together (Fig. 40).

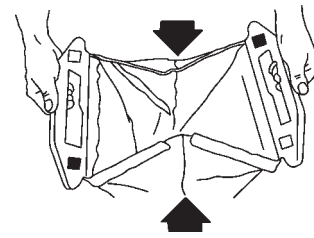

Figure 40

1012

16. Hang the rear bag handles on the bag hanger on the handle.

17. Grasp the bag assembly handle and slide it over the flange of the grass chute (Fig. 41). Push downward on the bag assembly handle until it seats into position.

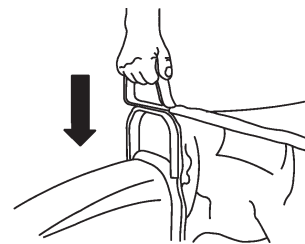

Figure 41

1010

18. Ensure that the bag is taut on the top cloth area between the front bag handle and the rear bag hanger handles. If the bag is too tight or too loose, adjust it as follows:

- A. Remove the bag from the rear bag hanger.
- B. Remove the bolts and knobs that secures the hanger clamps to the handle sections (Fig. 39).
- C. Assemble the hanger clamps on the handle sections, using the set of holes that best holds the bag taut.

Note: Using the lower holes tightens the bag assembly; using the upper holes loosens the assembly.

19. Connect the wire to the spark plug.

Note: Under normal use, the bag will deteriorate and wear. Check the grass bag often and replace it when necessary with a genuine Lawn-Boy replacement bag. A weakened or inferior bag may let objects pass through and cause damage or an injury.

Installing the Cover Plate

To convert from mulching operation to side discharge, remove the mulch plate and install a cover plate.

! **WARNING** !

POTENTIAL HAZARD

- An uncovered discharge opening will allow the lawn mower to throw objects in the operator's or bystander's direction. Also, contact with the blade could occur.

WHAT CAN HAPPEN

- Thrown objects or blade contact can cause serious injury.

HOW TO AVOID THE HAZARD

- Never operate the lawn mower unless you install a cover plate, a mulch plate, or a grass chute and catcher.

1. Stop the engine and wait for all moving parts to stop.
2. Disconnect the wire from the spark plug (Fig. 7).
3. Remove the wing screw that fastens the mulch plate to the housing (Fig. 34).
4. Slide the mulch plate counterclockwise and pull it up and out of the lawn mower housing.
5. Slide the cover plate over the shoulder bolts (Fig. 42).

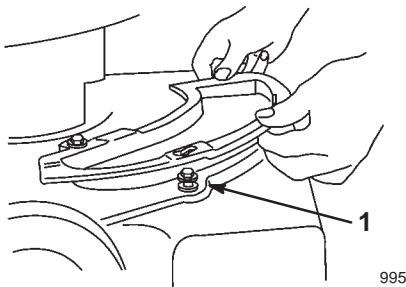

Figure 42

1. Shoulder bolt

6. Slide the cover plate clockwise.
7. Secure the cover plate with the wing screw.
8. Connect the wire to the spark plug (Fig. 7).

Installing the Mulch Plate

To convert from side discharge operation to mulching, remove the cover plate and install the mulch plate.

! **WARNING** !

POTENTIAL HAZARD

- An uncovered discharge opening will allow the lawn mower to throw objects in the operator's or bystander's direction. Also, contact with the blade could occur.

WHAT CAN HAPPEN

- Thrown objects or blade contact can cause serious injury.

HOW TO AVOID THE HAZARD

- Never operate the lawn mower unless you install a cover plate, a mulch plate, or a grass chute and catcher.

1. Stop the engine and wait for all moving parts to stop.
2. Disconnect the wire from the spark plug (Fig. 7).
3. Remove the wing screw that fastens the cover plate to the housing (Fig. 34).
4. Slide the cover plate counter clockwise and remove it from the lawn mower housing.
5. Place the front corner of the mulch plate baffle into the deck opening (Fig. 35).
6. Rotate the mulch plate counterclockwise and push it down into the deck opening (Fig. 35).

Note: The mulch plate baffle must go behind the front deck baffle and between the blade and toe guard to prevent it from contacting the blade.

7. Slide the mulch plate over the shoulder bolts (Fig. 43).

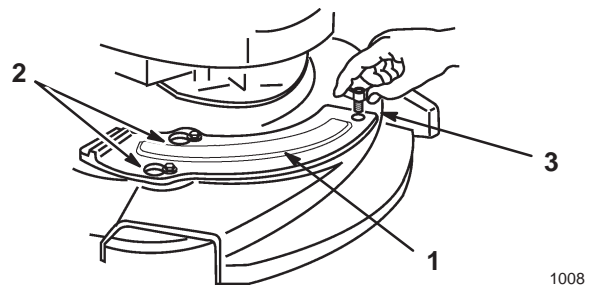

Figure 43

1. Mulch plate
2. Shoulder bolts
3. Wing screw

8. Slide the mulch plate clockwise.
9. Secure the mulch plate with the wing screw (Fig. 43).

10. Check the clearance between the blade tips and the baffle, ensuring that there is no contact (Fig. 38).

Note: The baffle must go behind the front deck baffle and between the blade and toe guard to prevent contact with the blade (Fig. 38).

11. Connect the wire to the spark plug.

Note: Use only a genuine Lawn-Boy replacement cutting blade. Other blades may strike the mulch plate when you start and run the engine.

Troubleshooting

Lawn-Boy designed and built your lawn mower for trouble-free operation. Check the following components and items carefully. If a problem continues, see your Authorized Service Dealer.

PROBLEM	CORRECTIVE ACTION
Engine does not start	<ol style="list-style-type: none"> 1. Fill the fuel tank with a fresh gasoline-and-oil mixture. 2. Move the throttle lever to the <i>Fast</i> position. 3. Press the primer three times. 4. Connect the wire to the spark plug. 5. Clean the spark plug, check the spark plug gap, and replace the spark plug if it is damaged.
Engine starts hard or loses power	<ol style="list-style-type: none"> 1. Move the throttle to the <i>Fast</i> position. 2. Drain and fill the fuel tank with a fresh gasoline-and-oil mixture. 3. Clean the fuel cap vent hole. 4. Clean or replace the air filter element. 5. Clean the lawn mower discharge chute. 6. Clean the underside of the lawn mower deck. 7. Clean the spark plug, check the spark plug gap, and replace the spark plug if it is damaged.
Engine runs rough	<ol style="list-style-type: none"> 1. Connect the wire to the spark plug. 2. Clean the spark plug, check the spark plug gap, and replace the spark plug if it is damaged. 3. Move the throttle lever to the <i>Fast</i> position. 4. Clean or replace the air filter.
Lawn mower or engine vibrates excessively	<ol style="list-style-type: none"> 1. Balance the blade. 2. Tighten the blade mounting nut. 3. Clean the lawn mower discharge chute. 4. Clean the underside of the lawn mower deck. 5. Tighten the engine mounting bolts.
Uneven cutting pattern	<ol style="list-style-type: none"> 1. Place all four wheels at the same height. 2. Sharpen and balance the blade. 3. Change the mowing pattern. 4. Clean the underside of the lawn mower deck.

PROBLEM	CORRECTIVE ACTION
Discharge chute plugs	<ol style="list-style-type: none"> 1. Move the throttle lever to the <i>Fast</i> position. 2. Raise the cutting height. 3. Allow the grass to dry before mowing. 4. Clean the underside of the lawn mower deck.
Lawn mower does not self-propel	<ol style="list-style-type: none"> 1. Make sure the end of the cable spring is hooked into the drive bracket. 2. Adjust the self-propel drive cable. 3. Clean debris from under the belt cover.

Your Warranty Rights and Obligations

The U.S. Environmental Protection Agency (EPA), Lawn-Boy, and Lawn-Boy Warranty Company are pleased to explain the emission control system warranty on your 1997 and later utility/lawn/garden equipment engine. 1997 and later model year utility/lawn/garden equipment engines must be designed, built and equipped, at the time of sale, to meet the U.S. EPA regulations for small non-road engines. The equipment engine must be free from defects in materials and workmanship, which cause it to fail to conform with U.S. EPA standards, for the first two years of engine use from the date of sale to the ultimate purchaser. Lawn-Boy and Lawn-Boy Warranty Company warrant the emission control system on your utility/lawn/garden equipment engine for the period of time listed above, provided there has been no abuse, neglect, or improper maintenance of your utility/lawn/garden equipment engine.

Your emission control system may include parts such as the carburetor or fuel injection system, the ignition system, and catalytic converter. Also included may be hoses, belts, connectors, and other emission related assemblies.

Where a warrantable condition exists, Lawn-Boy and Lawn-Boy Warranty Company promise to repair your engine at no cost to you, including diagnosis, parts, and labor.

Manufacturer's Warranty Coverage

Lawn-Boy and its affiliate, Lawn-Boy Warranty Company, pursuant to an agreement between them, jointly warrant the 1997 and later utility/lawn/garden equipment engines for two years from the date of delivery. If any emission-related part on your engine is defective in materials or workmanship, we will repair or replace the part, free of charge.

Owner Responsibilities

As the engine owner, you are responsible for the performance of the required maintenance listed in your operator's manual. We recommend that you retain all receipts covering maintenance on your equipment, but we cannot deny warranty solely for the lack of receipts or for your failure to ensure the performance of all scheduled maintenance.

Any replacement part or service that is equivalent in performance and durability may be used in non-warranty maintenance or repairs, and shall not reduce the warranty obligations of the engine manufacturer.

As the engine owner, you should be aware that we may deny you warranty coverage if your engine or a part has failed due to abuse, neglect, improper maintenance, or unapproved modifications or parts.

You are responsible for presenting your equipment engine to an Authorized Service Dealer as soon as a problem exists. The warranty repairs should be completed in a reasonable amount of time, not to exceed thirty (30) days.

If you have any questions regarding your warranty rights and responsibilities, or if you need a referral to a Lawn-Boy Service Dealer, please feel free to contact us at:

Customer Service Department
Lawn-Boy Warranty Company
8111 Lyndale Avenue South
Bloomington, MN 55420-1196
952-888-8801 or 800-LB-MOWER (800-526-6937)

Warranted Parts

The warranty period begins on the date the engine or equipment is delivered to a retail purchaser. Lawn-Boy and Lawn-Boy Warranty Company jointly warrant to the initial owner and each subsequent purchaser that the engine is free from defects in materials and

workmanship, which cause the engine to fail to conform with applicable regulations, for a period of two years.

Failures caused by abuse, neglect, or improper maintenance are not covered. The use of add-on or modified parts can be grounds for disallowing a warranty claim. We are not liable to cover failures of warranted parts caused by the use of add-on or modified parts. We are liable for damages to other engine components caused by the failure of a warranted part still under warranty. The owner is responsible for the performance of the required maintenance, as defined in the operator's manual.

Any warranted part which is not scheduled for replacement as required maintenance, or which is scheduled only for regular inspection to the effect of "repair or replace as necessary" shall be warranted for the warranty period. Any warranted part which is scheduled for replacement as required maintenance shall be warranted for the period of time up to the first scheduled replacement point for that part. Coverage under this warranty extends only to the parts listed below (the emissions system parts) to the extent that these parts were present on the engine when purchased.

- Fuel Metering System
 - Cold start enrichment system including the choke mechanism or priming system
 - Fuel pump
 - Air fuel ratio feedback system
 - Carburetor and internal parts
 - Fuel injection system
- Air Induction System
 - Air cleaner
 - Reed intake system
 - Intake manifold
 - Controlled hot air intake system
- Ignition System
 - Spark plug(s)
 - Ignition coils and electronics
 - Advance/retard mechanisms
- Catalytic Converter/Thermal Reactor System
 - Catalytic converter
 - Thermal reactor
 - Exhaust manifold
- Air Injection System
 - Air injection system or pulse valve
 - Valves affecting distribution of air
- Exhaust Gas Recirculation (EGR) System
 - EGR valve body and piping system connecting to the intake side of the engine
 - EGR control system
- Particulate Controls
 - Traps, filters, precipitators, and any other device used to capture particulate emissions
- Miscellaneous Items Used in the Above Systems
 - Vacuum, temperature, and time-sensitive valves and switches
 - Electronic controls
 - Hoses, connectors, and assemblies of same

How to Get Warranty Service

Should you feel your Lawn-Boy Product requires warranty service, contact the dealer who sold you the product or any Authorized Service Dealer or Master Service Dealer. The Yellow Pages of your telephone directory is a good reference source. The dealer will either arrange service at his/her dealership or recommend another Authorized Service Dealer who may be more convenient. You may need proof of purchase (copy of registration card, sales receipt, etc.) for warranty validation. The owner shall not be charged for diagnostic labor which leads to the determination that a warranted part is defective, if the diagnostic work is performed at a warranty station.

General Conditions

Neither Lawn-Boy nor Lawn-Boy Warranty Company is liable for indirect, incidental or consequential damages in connection with the use of the Lawn-Boy Products covered by this warranty, except for damages to other engine components caused by the failure of a warranted part still under warranty.

All implied warranties of merchantability (that the product is fit for ordinary use) and fitness for use (that the product is fit for a particular purpose) are limited to the duration of the express warranty.

Some states do not allow exclusions of incidental or consequential damages, or limitations on how long an implied warranty lasts, so the above exclusions and limitations may not apply to you.

This warranty gives you specific legal rights, and you may also have other rights which vary from state to state.



Silver Series WPM
 SilverPro Series WPM
 Commercial WPM

The Lawn-Boy No-Worry Warranty

A Two-Year Full Warranty
 (Limited Warranty for Commercial Use)

Conditions and Products Covered

For a period of two years from the date of purchase, Lawn-Boy and its affiliate, Lawn-Boy Warranty Company, pursuant to an agreement between them, jointly promise to repair any Lawn-Boy Product used for normal residential purposes* if defective in materials or workmanship or if it stops functioning due to the failure of a component. The following time periods apply from the date of purchase:

<u>Products</u>	<u>Warranty Period</u>
• All Mowers	2 year full warranty
• All Batteries	1 year full warranty

This warranty covers the cost of parts and labor, but you must pay transportation costs.

This warranty applies to all Silver Series, SilverPro Series, and Commercial Series Walk Power Mowers.

* Normal residential purposes means use of the product on the same lot as your home. Use at more than one location is considered commercial use, and the commercial use warranty would apply.

Limited Warranty for Commercial Use

Lawn-Boy Walk Power Mowers used for commercial, institutional, or rental use are warranted against defects in materials or workmanship. Components failing due to normal wear are not covered by this warranty. The following time periods apply from the date of purchase:

<u>Products</u>	<u>Warranty Period</u>
• Commercial Series Mowers	1 year
• All Other Lawn-Boy Mowers	45 days

Instructions for Obtaining Warranty Service

Should you feel your Lawn-Boy Product contains a defect in materials or workmanship, contact the dealer who sold you the product or any Authorized Service Dealer or Master Service Dealer. The Yellow Pages of your telephone directory is a good reference source. The dealer will either arrange service at his/her dealership or recommend another Authorized Service Dealer who may be more convenient. You may need proof of purchase (copy of registration card, sales receipt, etc.) for warranty validation.

If for any reason you are dissatisfied with the Service Dealer's analysis of the defect in materials or workmanship or if you need a referral to a Lawn-Boy Service Dealer, please feel free to contact us at:

Customer Service Department
 Lawn-Boy Warranty Company
 8111 Lyndale Avenue South
 Bloomington, MN 55420-1196
 952-888-8801 or 800-LB-MOWER (800-526-6937)

Countries Other than the United States or Canada

Customers who have purchased Lawn-Boy products exported from the United States or Canada should contact their Lawn-Boy Distributor (Dealer) to obtain guarantee policies for your country, province, or state. If for any reason you are dissatisfied with your Distributor's service or have difficulty obtaining guarantee information, contact the Lawn-Boy importer. If all other remedies fail, you may contact us at Lawn-Boy Warranty Company.

Owner Responsibilities

You must maintain your Lawn-Boy Product by following the maintenance procedures described in the operator's manual. Such routine maintenance, whether performed by a dealer or by you, is at your expense.

Items and Conditions Not Covered

There is no other express warranty except for special emission system coverage on some products. This express warranty does not cover:

- Cost of regular maintenance service or parts, such as filters, fuel, lubricants, oil changes, spark plugs, blade sharpening, worn blade, cable/linkage adjustments, or brake and clutch adjustments.
- Any product or part which has been altered or misused or required replacement or repair due to accidents or lack of proper maintenance.
- Repairs necessary due to improper fuel, contaminants in the fuel system, or failure to properly prepare the fuel system prior to any period of non-use over three months.
- Repairs necessary due to improper battery care, electrical supply irregularities, or failure to properly prepare the mower prior to any period of non-use.
- Pickup and delivery charges.

All repairs covered by this warranty must be performed by an Authorized Lawn-Boy Service Dealer using Lawn-Boy approved replacement parts.

General Conditions

Repair by an Authorized Lawn-Boy Service Dealer is your sole remedy under this warranty.

Neither Lawn-Boy or Lawn-Boy Warranty Company is liable for indirect, incidental or consequential damages in connection with the use of the Lawn-Boy Products covered by this warranty, including any cost or expense of providing substitute equipment or service during reasonable periods of malfunction or non-use pending completion of repairs under this warranty.

Some states do not allow exclusions of incidental or consequential damages, or limitations on how long an implied warranty lasts, so the above exclusions and limitations may not apply to you.

This warranty gives you specific legal rights, and you may also have other rights which vary from state to state.