



Count on it.

Parts Catalog

**60in Chute Gate Kit
Z Master® 4000 Series Riding Mower**

Model No. 144-6572



Ordering Replacement Parts

To order replacement parts, please supply the part number, the quantity, and the description of each part desired.

Understanding Reference Numbers

Each identified part in an illustration has a reference number. The reference number for a part also appears in the parts list, along with other information about the part.

This catalog uses two special reference number formats, one to indicate parts in a service assembly and another to indicate the quantity of a given part in an illustration.

Service Assembly Reference Numbers

Parts in service assemblies have reference numbers in the form a:b. The a represents the reference number of the entire service assembly and the b represents a sequential number unique to each part within the service assembly.

For example, a wheel assembly might be identified by reference number 6, the tire by 6:1, the valve by 6:2, and the wheel by 6:3. When you order the assembly identified by reference number 6, you receive all parts identified by reference numbers 6:1, 6:2, and 6:3. However, you may also order any part individually. Reference numbers of this type appear in illustration and in parts lists.

Reference Numbers Indicating Quantity

In an illustration, if a reference number indicates more than one part, the reference number has the form nX y. The n represents the quantity of the part, the X is the multiplication symbol, and the y represents the reference number.

For example, in an illustration, the reference number 2X 37 means that two of the parts identified by reference number 37 are indicated.

Contents

Gate Chute Assembly No. 144-6572 4
Rubber Deflector Assembly No. 117-0469 5
Door Assembly No. 144-2693 6

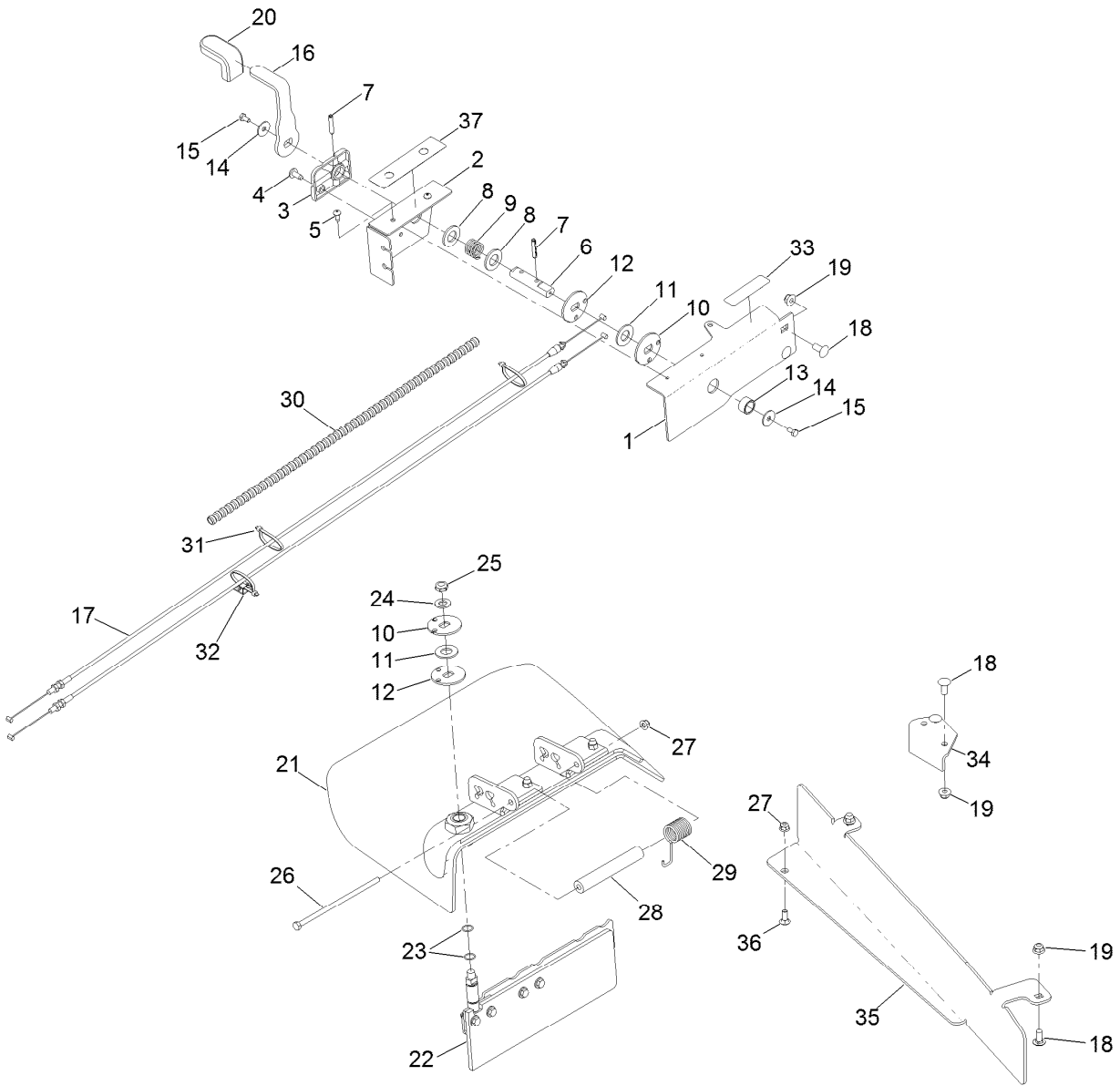

Gate Chute Assembly No. 144-6572

Ref.	Part Number	Qty.	Description	Ref.	Part Number	Qty.	Description
1	144-6555-01	1	Bracket-Mounting, Ocdc	20	132-4749	1	Grip-Lever
2	144-6556-01	1	Bracket-Cover	21	117-0469	1	Rubber Deflector ASM
3	108-2231	1	Block-Detent	22	144-2693	1	ASM-Door
4	138-9753	1	Screw	23	237-65	2	O-Ring
5	87-6620	2	Screw-Tph Thd Form	24	3256-26	1	Washer-Flat
6	144-6557	1	Pin-Pivot	25	3296-45	1	Nut-Hex
7	32121-15	2	Pin-Roll	26	322-50	1	Screw-HH
8	3256-28	2	Washer-Flat	27	104-8300	2	Nut-HF, NI
9	87-3660	1	Spring-Compression	28	105-4622	1	Spacer
10	108-7218	2	Pulley-Top	29	108-4052	1	Spring-Torsion
11	108-7217	2	Pulley-Middle	30	108-7247	1	Tube-Convoluted
12	108-7216	2	Pulley-Bottom	31	3290-378	3	Tie-Cable
13	144-6558	1	Bushing	32	93-3922	1	Mount-Tie, Cable
14	3256-82	2	Washer-Flat	33	99-8936	1	Decal-Control, Motion
15	321-2	2	Screw-HH	34	144-2695-01	1	Baffle-Discharge
16	144-6559	1	Handle-Pivot	35	135-0154-01	1	Baffle-Bagger
17	108-7258	2	Cable	36	3230-16	1	Screw-CARR
18	3231-27	6	Screw-CARR	37	144-6593	1	Decal-Chute Gate
19	104-8301	6	Nut-HF, NI				

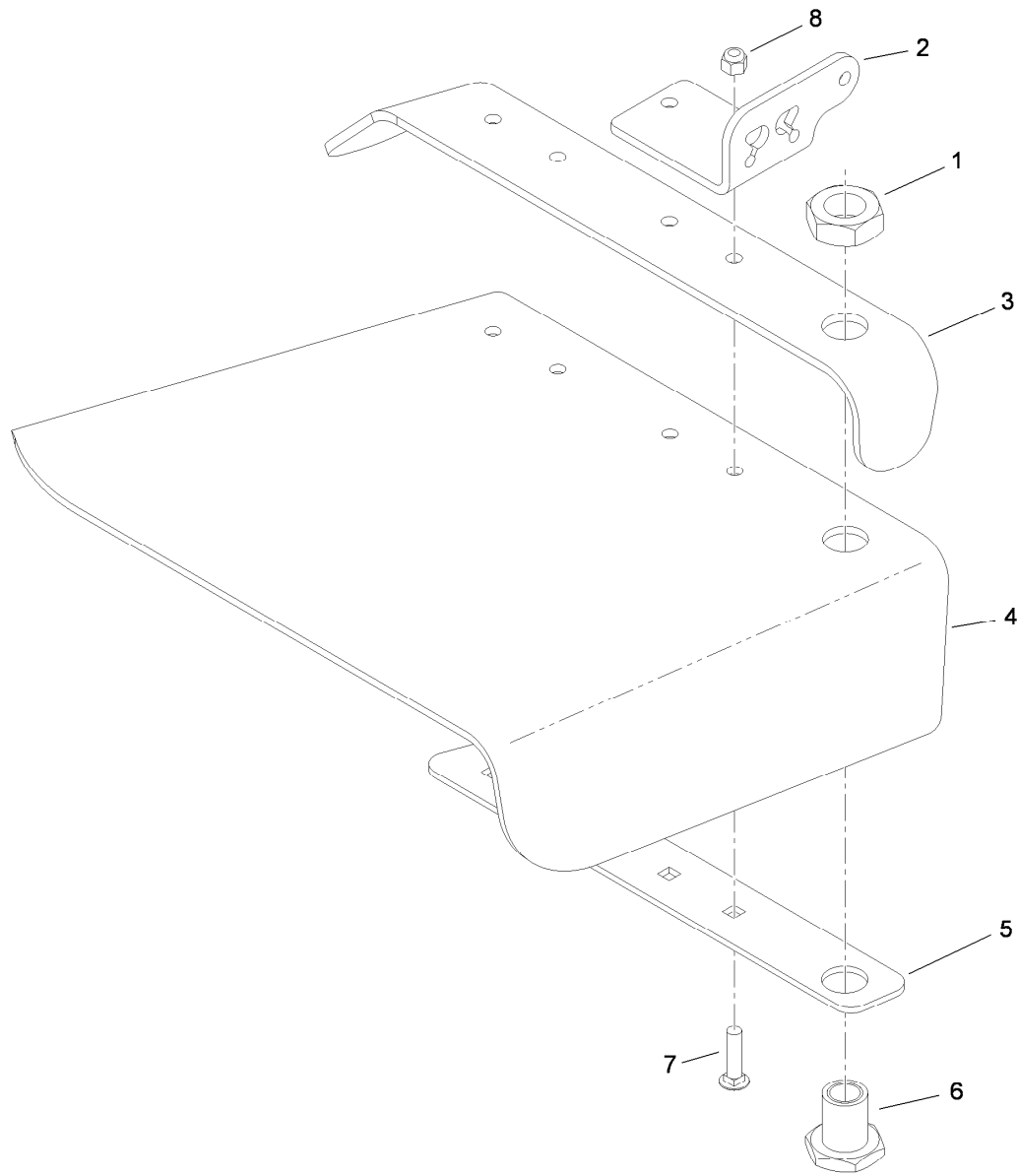

Rubber Deflector Assembly No. 117-0469

<i>Ref.</i>	<i>Part Number</i>	<i>Qty.</i>	<i>Description</i>
1	67-5840	1	Nut-Jam
2	108-2241-01	2	Plate-Hinge
3	108-2245-01	1	Deflector
4	117-0470	1	Deflector-Chute, Rubber
5	108-2247-03	1	Strap-Discharge
6	108-7215	1	Hub ASM
7	3231-4	4	Screw-CARR
8	3296-39	4	Nut-Lock, NI

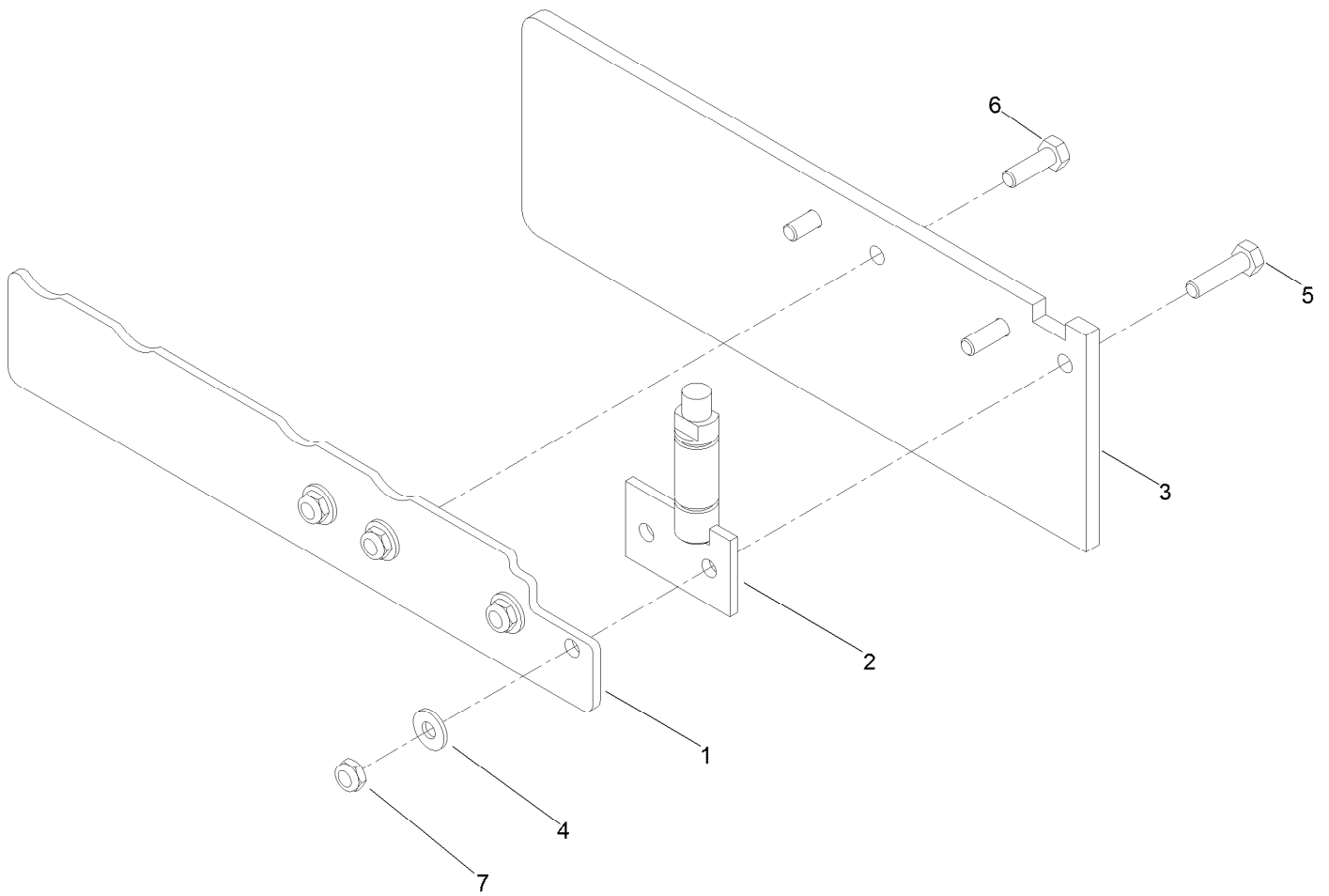

Door Assembly No. 144-2693

<i>Ref.</i>	<i>Part Number</i>	<i>Qty.</i>	<i>Description</i>
1	144-2694-01	1	Plate-Door
2	107-8505	1	Hinge-Gate
3	107-3197	1	Gate-Chute, Rubber
4	3256-2	8	Washer-Flat
5	322-6	2	Screw-HH
6	322-5	2	Screw-HH
7	3296-47	4	Nut-Lock, NI

Notes:



Count on it.