



# SnowMaster®/Snow Max Snowthrowers Souffleuse à neige SnowMaster®/Snow Max

## Quick Start Guide/Guide de Démarrage Rapide

\*

**Register your product.  
Enregistrer votre produit.**

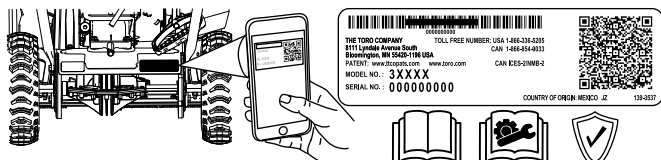

**▲ WARNING**

**CALIFORNIA**  
Proposition 65 Warning

The engine exhaust from this product contains chemicals known to the State of California to cause cancer, birth defects, or other reproductive harm.

Use of this product may cause exposure to chemicals known to the State of California to cause cancer, birth defects, or other reproductive harm.

For the *Operator's Manual*, the complete warranty details, or to register your product, use the QR code, or visit [www.Toro.com](http://www.Toro.com).  
Pour vous procurer le Manuel de l'utilisateur, des détails complets sur la garantie ou pour enregistrer votre produit, utilisez le code QR ou rendez-vous sur [www.Toro.com](http://www.Toro.com).



Read the *Operator's Manual*.

Lisez le *Manuel de l'utilisateur*.



Cutting/dismemberment hazards of hand or foot, impeller and auger.

Risque de coupure/mutilation des mains ou des pieds par la turbine et la vis sans fin



Do not place your hand in the chute; shut off the engine before leaving the operator's position and use a tool to clear the chute.

Ne placez pas la main dans la goulotte ; coupez le moteur avant de quitter la position d'utilisation et dégagez la goulotte avec un outil.



Remove the ignition key and read the instructions before servicing or performing maintenance.

Retirez la clé de contact et lisez les instructions avant de procéder à l'entretien ou à des révisions.



Fuel spill hazard—do not tip the machine backward.

Risque de déversement de carburant – n'inclinez pas la machine en arrière.



Thrown object hazard

Risque de projections d'objet



Keep bystanders a safe distance away from the machine.

Tenez tout le monde à une distance suffisante de la machine.



Shut off the engine and wait for the auger to stop before leaving the machine.

Coupez le moteur et attendez l'arrêt complet de la vis sans fin avant de quitter la machine.



Stay away from moving parts; keep all guards and shields in place.

Ne vous approchez pas des pièces mobiles, et laissez toutes les protections et tous les capots en place.

You may also mail us a written request for a printed copy of the product warranty.  
Vous pouvez également nous envoyer une demande écrite pour obtenir une copie imprimée de la garantie du produit.

**1**

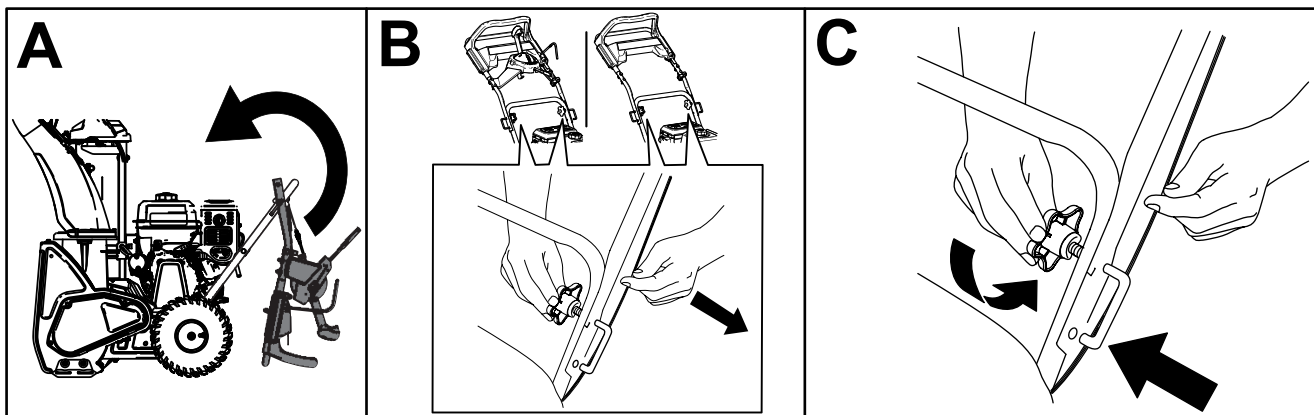

g257569



2

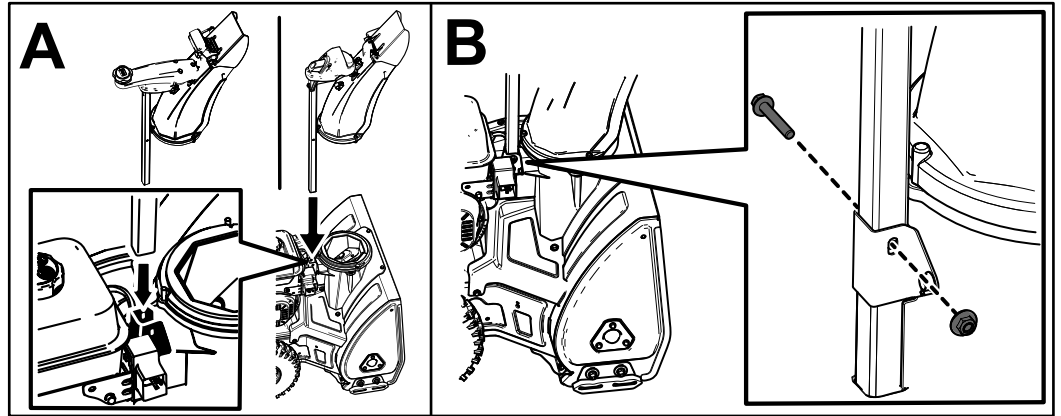
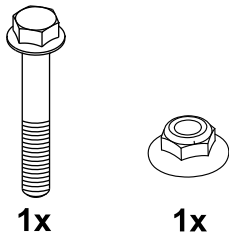

g257570

3

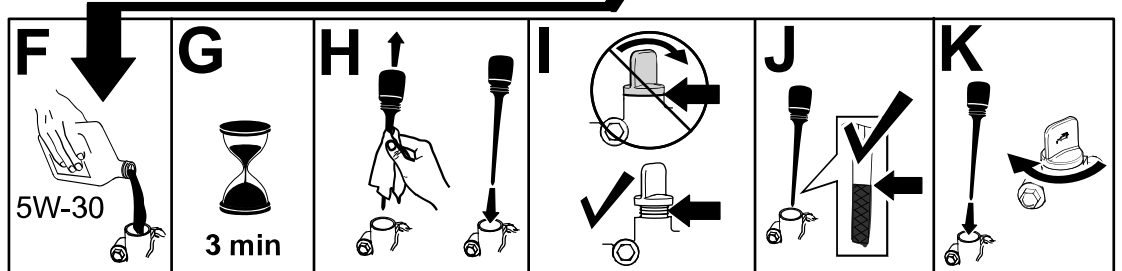
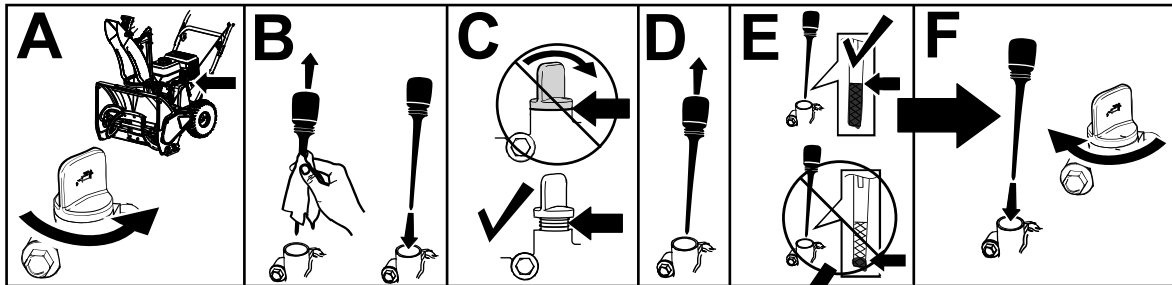

g289753

4

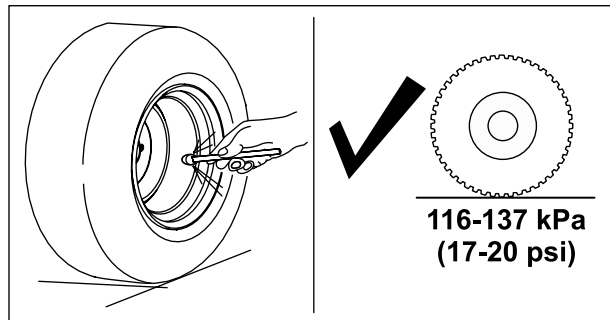
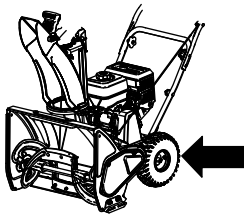

g257573

5

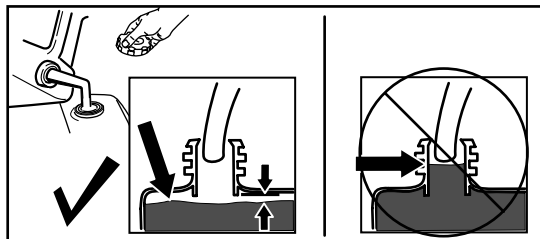
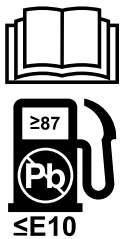

g257567

**6**

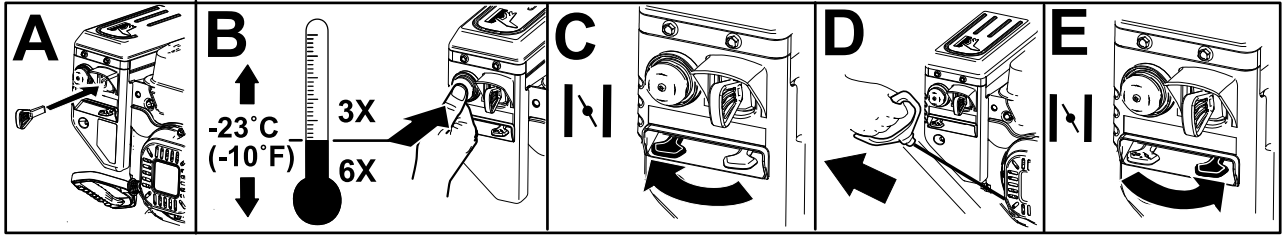

g289193

**7**

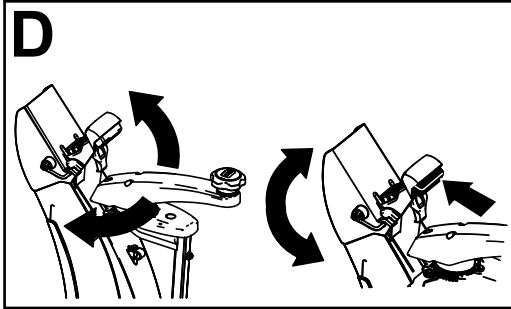
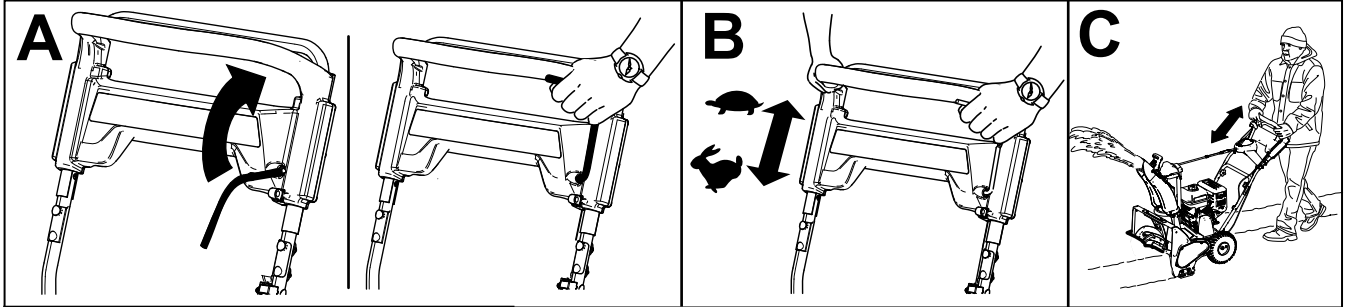

g289194

**8**

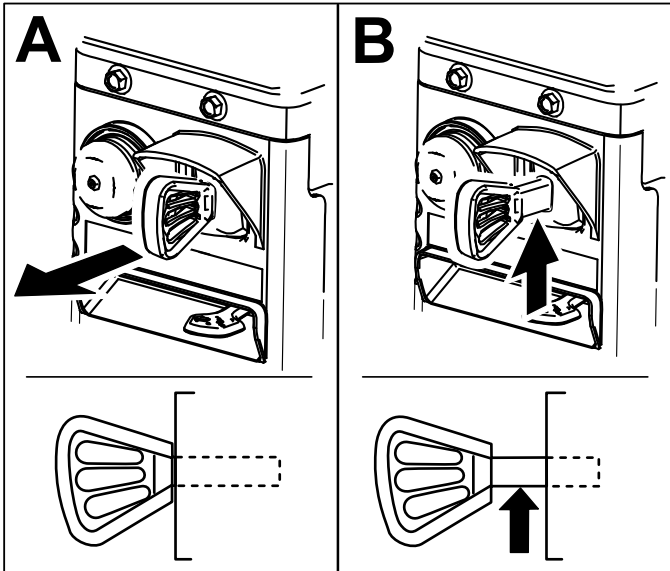

g257576

