



Rake and Vac™ and Super Blower/Vacuum

Model No. 51617—Serial No. 319000001 and Up

Model No. 51618—Serial No. 319000001 and Up

Operator's Manual



If you have questions or problems, call toll free 1-888-367-6631 (US), 1-888-430-1687 (Canada), or 1-800-574-3312 (Mexico) before returning this product.

You may contact Toro directly at www.Toro.com for product and accessory information, help finding a dealer, the complete warranty details, or to register your product.

⚠ WARNING

CALIFORNIA Proposition 65 Warning

The power cord on this product contains lead, a chemical known to the State of California to cause birth defects or other reproductive harm. Wash hands after handling.

Use of this product may cause exposure to chemicals known to the State of California to cause cancer, birth defects, or other reproductive harm.

IMPORTANT SAFETY INSTRUCTIONS

When using an electrical appliance, basic precautions should always be followed, including the following:

READ ALL INSTRUCTIONS BEFORE USING VAC/BLOWER

WARNING—To reduce the risk of fire, electric shock, or injury, follow these safety instructions.

To ensure maximum safety, best performance, and to gain knowledge of the appliance, it is essential that you or any other operator of the appliance read and understand the contents of this manual before operating the appliance. Pay particular attention to the safety-alert symbol ⚠ which means CAUTION, WARNING or DANGER—personal safety instruction. Read and understand the instruction because it has to do with safety. **Failure to comply with these instructions may result in personal injury, risk of fire, or electrical shock.**

Do not leave the appliance when plugged in. Unplug it from the outlet when not in use and before servicing.

WARNING—To reduce the risk of electric shock, **do not** use the appliance on wet surfaces. **Do not** expose it to rain. Store it indoors.

Do not allow the appliance to be used as a toy. Do not use it near children. Do not let children use the appliance.

Use the appliance only as described in this manual. Use only the manufacturer's recommended attachments.

Dress properly. Keep hair, loose clothing, fingers, and all parts of the body away from openings and moving parts. Be aware of the position of the blower and the air inlets during operation. Loose clothing, jewelry, and hair can be drawn into the inlets (refer to the following figure) and may result in personal injury. Always wear substantial footwear, long pants, and eye protection.

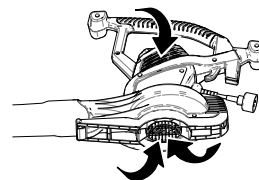

g246212

Caution—Moving Parts—do not operate the appliance without the air inlet guard (bottom inlet cover) in place. Refer to Setup for proper assembly instructions.

Do not use the appliance with a damaged electrical cord or plug. If it is not working as it should, has been dropped, damaged, left outdoors, or dropped into water, return it to a service dealer.

Do not pull or carry the appliance by the cord, use the electrical cord as a handle, close a door on the cord, or pull the cord around sharp edges or corners. Keep the cord away from heated surfaces.

Do not unplug the appliance by pulling on the electrical cord. To unplug the cord, grasp the plug, not the cord.

Do not handle the plug or appliance with wet hands.

Do not put any object into the openings. Do not use the appliance with any opening blocked; keep it free of dust, lint, hair, and anything that may reduce air flow.

Turn off all controls before unplugging the appliance.

Use extra care when cleaning on stairs.

Do not use the appliance to vacuum flammable or combustible liquids, such as gasoline, or use in areas where they may be present.

This appliance is provided with double electrical insulation. Use only identical replacement parts. See instructions for servicing double-insulated appliances.



Do not vacuum anything that is burning or smoking, such as cigarettes, matches, or hot ashes.

Do not use the appliance without the vacuum bag or proper attachments in place.

SAVE THESE INSTRUCTIONS

Safety and Instructional Decals



Safety decals and instructions are easily visible to the operator and are located near any area of potential danger. Replace any decal that is damaged or missing.

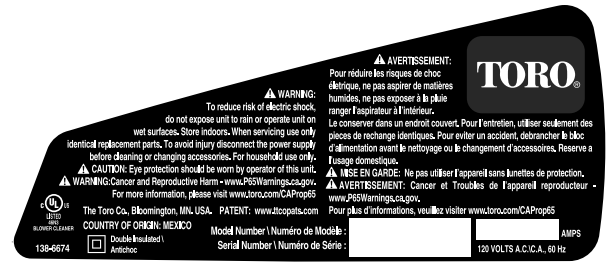

138-6674

decal138-6674

Setup

Register your product at www.Toro.com so that Toro can notify you in the case of a safety or warranty product recall.

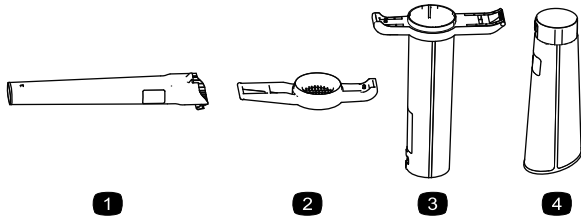

Figure 2

g224170

- | | |
|-----------------------|----------------------|
| 1. Blower tube | 3. Upper-vacuum tube |
| 2. Bottom inlet cover | 4. Lower-vacuum tube |

Assembling the Blower

Important: The motor should not run unless the bottom inlet cover is locked in place.

Note: If the motor runs without the bottom inlet cover in place, do not use the appliance. Return it to an Authorized Service Dealer.

Install the blower tube and bottom inlet cover.

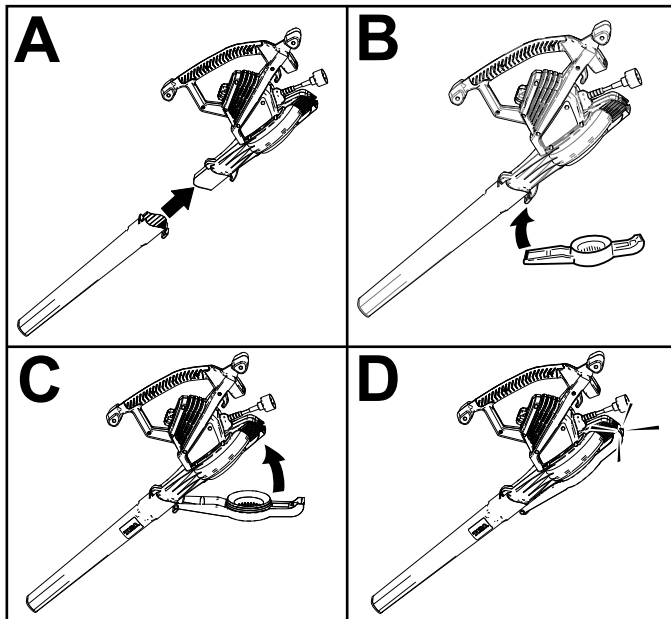

g227713

Converting from Blower to Vacuum

⚠ WARNING

The impeller rotates for a few seconds after you turn off the appliance and can cut or injure fingers.

Do not remove the bottom inlet cover when the motor is running or when the appliance is plugged into a power outlet.

1. Remove the bottom inlet cover and the blower tube.

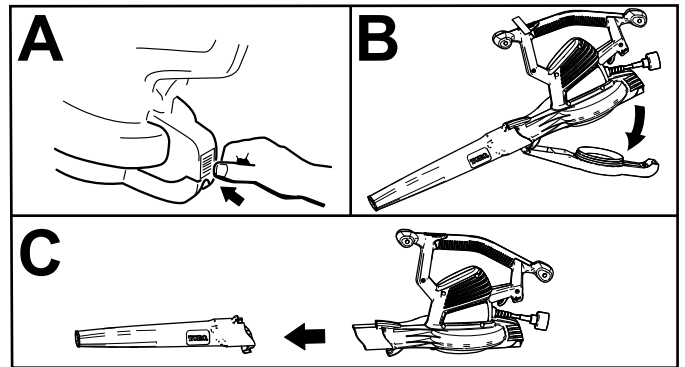

g227756

2. Install the vacuum tube and bag.

Important: The motor should not run unless the vacuum tube is locked in place.

Note: If the motor runs without the inlet cover in place, do not use the appliance. Return it to an Authorized Service Dealer.

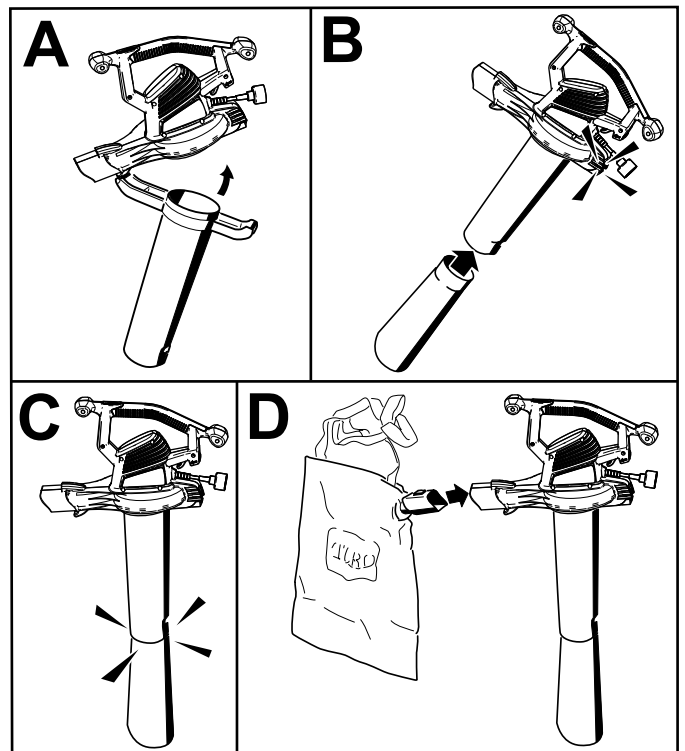

g227757

3. Adjust the bag strap as needed for comfortable operation.

Converting from Vacuum to Blower

1. Remove the vacuum bag and the vacuum tube.

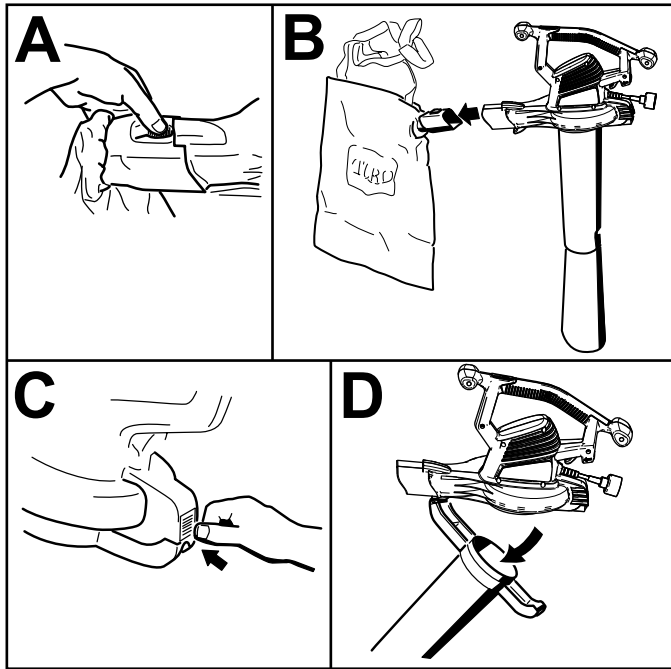

g227758

2. Install the blower tube and bottom inlet cover.

Important: The motor should not run unless the bottom inlet cover is locked in place.

Note: If the motor runs without the inlet cover in place, do not use the appliance. Return it to an Authorized Service Dealer.

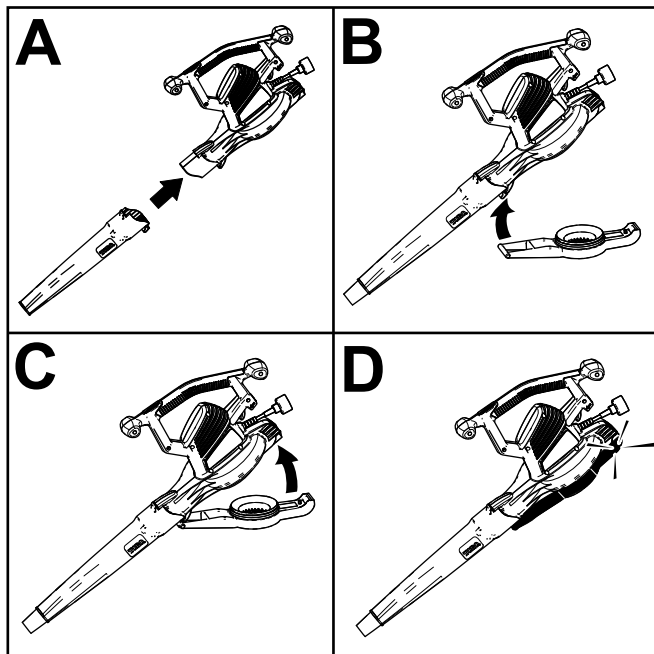

g227759

Operation

Important: This appliance is intended for outdoor, residential use only. Do not use it indoors or for commercial or industrial purposes. This appliance is for household use only.

Connecting to a Power Source

To reduce the risk of electric shock, this appliance has a polarized plug (i.e., one blade is wider than the other). Use only a polarized, UL listed (CSA certified in Canada) extension cord recommended for outdoor use. A polarized plug will fit in a polarized cord only one way. If the plug does not fit fully in the cord, reverse the cord. If it still does not fit, purchase a polarized extension cord. If you have a polarized extension cord and the extension cord plug does not fit fully into the wall receptacle, reverse the plug. If it still does not fit, contact a qualified electrician to install the proper outlet. Do not change the appliance or extension cord plug in any way.

Use only an extension cord recommended for outdoor use.

⚠ WARNING

If you do not fully seat the extension cord on the inlet plug, or if the plug and cord do not fit firmly, the loose plug could lead to overheating and cause a fire, possibly burning you or others.

- Ensure that you fully seat the cord on the plug.
- Check the connection regularly to ensure that the cord is firmly attached.
- Do not use a worn-out or loose extension cord.

Extension Cord Length	Minimum Wire Gage (A.W.G.)
7.6 m (25 feet)	16
15.0 m (50 feet)	16
30.5 m (100 feet)	14
45.7 m (150 feet)	10

Note: Do not use an extension cord over 45.7 m (150 feet) long.

Important: Check the extension cord frequently during use for holes or cracks in the insulation. Do not use a damaged cord. Do not run the cord through standing water or wet grass.

Secure the extension cord to the appliance using the cord lock system as shown.

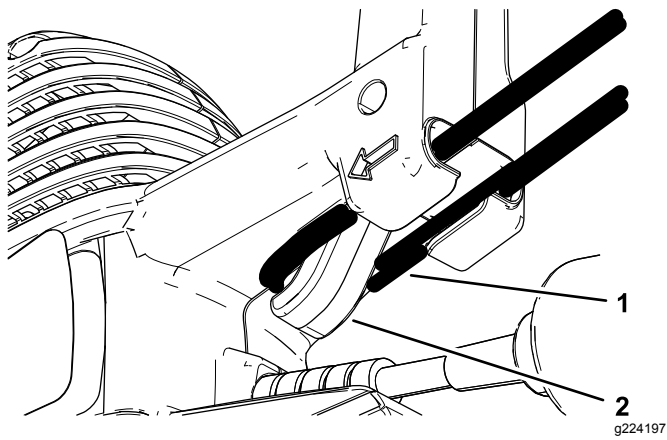

1. Extension cord 2. Cord lock

Using the Nozzles

Install the concentrator nozzle into the blower tube to help reach into narrow spaces or to remove matted debris from hard surfaces.

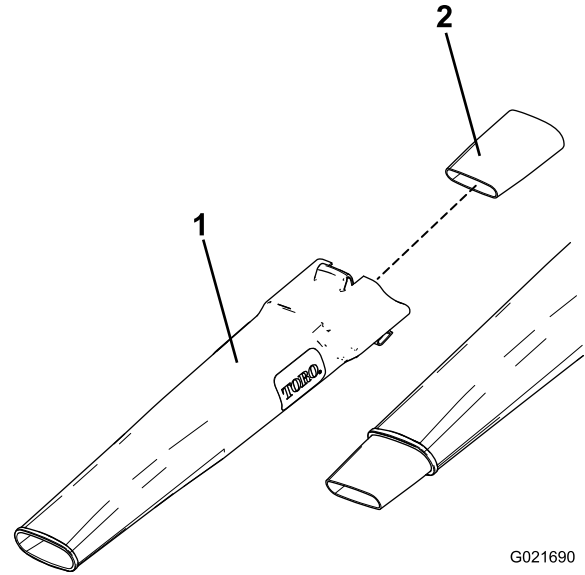

1. Blower tube 2. Concentrator nozzle

Starting/Stopping/Adjusting the Air Speed

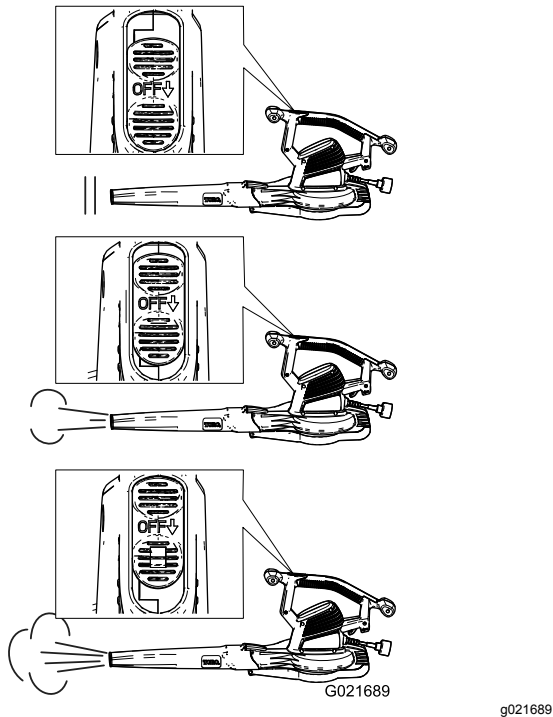

Using the Appliance as a Blower

The appliance used a blower is intended for residential use only. Use the blower outdoors to move debris as needed.

⚠ WARNING

Using the appliance as a blower can throw debris, possibly causing serious personal injury to you or bystanders.

- Do not blow hard objects such as nails, bolts, or rocks.
- Do not operate the blower near bystanders or pets.
- Use extra care when cleaning debris from stairs or other tight areas.
- Wear safety goggles or other suitable eye protection, long pants, and shoes.

Using the Appliance as a Vacuum

Using the appliance as a vacuum is intended for residential use only. Use it outdoors to collect debris as needed.

⚠ WARNING

Using the appliance as a vacuum can throw debris, possibly causing serious personal injury to you or bystanders.

- Do not operate the vacuum without the bag installed or with the bag zipper open.
- Do not vacuum sharp, pointed, or hard objects that could be thrown through the fabric of the bag, such as wires, staples, nails, or rocks.



G017098

g017098

Important: Vacuum only dry leaves and soft items. Hard items such as sticks, rocks, acorns, and pine cones will damage the impeller.

Important: Do not force the vacuum tube into a pile of debris or hold the tube upright while force feeding debris into the tube. Either action may clog and damage the impeller. If the vacuum starts to vibrate or make abnormal noise, stop it, *unplug* the cord, and check for the cause.

Emptying the Bag

1. Turn off and unplug the vacuum from the power source.
2. Empty any debris from the bag.



G017099

g017099

Do not store debris in the bag. To clean the bag, turn it inside out and shake out any excess debris. Once a year, hand wash the bag in soapy water and allow it to air dry.

⚠ DANGER

Normal usage of the bag causes it to wear and deteriorate over time. A worn or deteriorated bag allows small objects to be thrown through the bag, possibly injuring you or bystanders.

Check the bag frequently. If it is worn or deteriorated, replace it with a genuine Toro vacuum bag.

Always use the shoulder strap whenever you use the appliance with the bag. This prevents the bag from dragging on the ground, reducing bag wear and deterioration.

Separating the Vacuum Tube

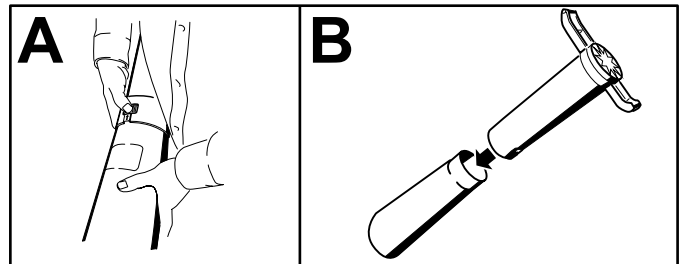

g227719

Removing Clogged Debris from the Impeller

1. Turn off and **unplug** the appliance from the power source and wait for all moving parts to stop.
2. Remove the vacuum tube then remove the debris from impeller blades.

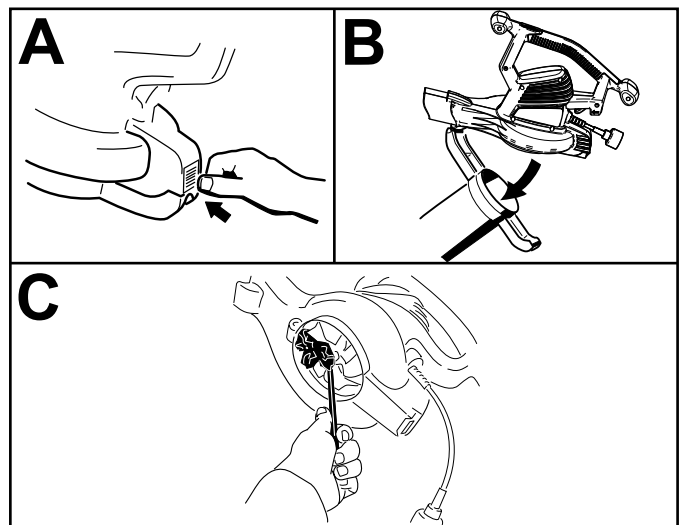

g227760

3. Check the impeller for any signs of damage. If it is damaged, contact your Authorized Service Dealer.
4. Install the vacuum tube, or, if you want to switch to blower mode, the bottom inlet cover. Refer to [Converting from Blower to Vacuum \(page 3\)](#) or [Converting from Vacuum to Blower \(page 4\)](#) for more information.

Service

Toro has designed this product to give you years of trouble free use. Should it need service, bring the product to your Authorized Service Dealer. Your Toro Dealer is specially trained to repair Toro products and will ensure that your Toro stays “All” Toro.

Double-insulated Appliances

In a double-insulated appliance, two systems of insulation are provided instead of grounding. No grounding means is provided on a double-insulated appliance, nor should a means for grounding be added to the appliance. Servicing a double-insulated appliance requires extreme care and knowledge of the system, and should be done only by the qualified service personnel at your Authorized Toro Service Dealer. Replacement parts for a double-insulated appliance must be identical to the parts they replace. A double-insulated appliance is marked with the words “Double Insulation” or “Double Insulated.” The symbol (square within a square)  may also be marked on the appliance.

Storage

Store the appliance and extension cord indoors, in a cool dry location, out of reach of children and animals.

Troubleshooting

If your blower fails to run when you turn it on, check the following before contacting your Authorized Service Dealer:

- Ensure that the bottom inlet cover or vacuum tube is locked in place.
- Ensure that the power cord is secured in place at the back of the appliance and that the plug is fully seated.

California Proposition 65 Warning Information

What is this warning?

You may see a product for sale that has a warning label like the following:



WARNING: Cancer and Reproductive Harm—www.p65Warnings.ca.gov.

What is Prop 65?

Prop 65 applies to any company operating in California, selling products in California, or manufacturing products that may be sold in or brought into California. It mandates that the Governor of California maintain and publish a list of chemicals known to cause cancer, birth defects, and/or other reproductive harm. The list, which is updated annually, includes hundreds of chemicals found in many everyday items. The purpose of Prop 65 is to inform the public about exposure to these chemicals.

Prop 65 does not ban the sale of products containing these chemicals but instead requires warnings on any product, product packaging, or literature with the product. Moreover, a Prop 65 warning does not mean that a product is in violation of any product safety standards or requirements. In fact, the California government has clarified that a Prop 65 warning "is not the same as a regulatory decision that a product is 'safe' or 'unsafe.'" Many of these chemicals have been used in everyday products for years without documented harm. For more information, go to <https://oag.ca.gov/prop65/faqs-view-all>.

A Prop 65 warning means that a company has either (1) evaluated the exposure and has concluded that it exceeds the "no significant risk level"; or (2) has chosen to provide a warning based on its understanding about the presence of a listed chemical without attempting to evaluate the exposure.

Does this law apply everywhere?

Prop 65 warnings are required under California law only. These warnings are seen throughout California in a wide range of settings, including but not limited to restaurants, grocery stores, hotels, schools, and hospitals, and on a wide variety of products. Additionally, some online and mail order retailers provide Prop 65 warnings on their websites or in catalogs.

How do the California warnings compare to federal limits?

Prop 65 standards are often more stringent than federal and international standards. There are various substances that require a Prop 65 warning at levels that are far lower than federal action limits. For example, the Prop 65 standard for warnings for lead is 0.5 µg/day, which is well below the federal and international standards.

Why don't all similar products carry the warning?

- Products sold in California require Prop 65 labelling while similar products sold elsewhere do not.
- A company involved in a Prop 65 lawsuit reaching a settlement may be required to use Prop 65 warnings for its products, but other companies making similar products may have no such requirement.
- The enforcement of Prop 65 is inconsistent.
- Companies may elect not to provide warnings because they conclude that they are not required to do so under Prop 65; a lack of warnings for a product does not mean that the product is free of listed chemicals at similar levels.

Why does Toro include this warning?

Toro has chosen to provide consumers with as much information as possible so that they can make informed decisions about the products they buy and use. Toro provides warnings in certain cases based on its knowledge of the presence of one or more listed chemicals without evaluating the level of exposure, as not all the listed chemicals provide exposure limit requirements. While the exposure from Toro products may be negligible or well within the "no significant risk" range, out of an abundance of caution, Toro has elected to provide the Prop 65 warnings. Moreover, if Toro does not provide these warnings, it could be sued by the State of California or by private parties seeking to enforce Prop 65 and subject to substantial penalties.