



# Rake and Vac™ and Super Blower/Vacuum

Model No. 51617—Serial No. 314000001 and Up

Model No. 51618—Serial No. 314000001 and Up

## Operator's Manual



If you have questions or problems, call toll free 1-888-367-6631 (US), 1-888-430-1687 (Canada), or 1-800-574-3312 (Mexico) before returning this product.

### ⚠ WARNING

#### CALIFORNIA Proposition 65 Warning

Use of this product may cause exposure to chemicals known to the State of California to cause cancer, birth defects, or other reproductive harm.

## IMPORTANT SAFETY INSTRUCTIONS

When using an electrical appliance, basic precautions should always be followed, including the following:

### READ ALL INSTRUCTIONS BEFORE USING VAC/BLOWER

**WARNING**—To reduce the risk of fire, electric shock, or injury, follow these safety instructions.

To ensure maximum safety, best performance, and to gain knowledge of the appliance, it is essential that you or any other operator of the appliance read and understand the contents of this manual before operating the appliance. Pay particular attention to the safety-alert symbol ⚠ which means CAUTION, WARNING or DANGER—personal safety instruction. Read and understand the instruction because it has to do with safety. **Failure to comply with these instructions may result in personal injury, risk of fire, or electrical shock.**

Do not leave the appliance when plugged in. Unplug it from the outlet when not in use and before servicing.

**WARNING**—To reduce the risk of electric shock, **do not** use the appliance on wet surfaces. **Do not** expose it to rain. Store it indoors.

Do not allow the appliance to be used as a toy. Do not use it near children. Do not let children use the appliance.

Use the appliance only as described in this manual. Use only the manufacturer's recommended attachments.

**Dress properly.** Keep hair, loose clothing, fingers, and all parts of the body away from openings and moving parts. Be aware of the position of the blower and the air inlets during operation. Loose clothing, jewelry, and hair can be drawn into the inlets (refer to the following figure) and may result in personal injury. Always wear substantial footwear, long pants, and eye protection.

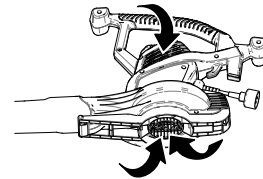

g246212

**Caution—Moving Parts**—do not operate the appliance without the air inlet guard (bottom inlet cover) in place. Refer to Setup for proper assembly instructions.

Do not use the appliance with a damaged electrical cord or plug. If it is not working as it should, has been dropped, damaged, left outdoors, or dropped into water, return it to a service dealer.

Do not pull or carry the appliance by the cord, use the electrical cord as a handle, close a door on the cord, or pull the cord around sharp edges or corners. Keep the cord away from heated surfaces.

Do not unplug the appliance by pulling on the electrical cord. To unplug the cord, grasp the plug, not the cord.

Do not handle the plug or appliance with wet hands.

Do not put any object into the openings. Do not use the appliance with any opening blocked; keep it free of dust, lint, hair, and anything that may reduce air flow.

Turn off all controls before unplugging the appliance.

Use extra care when cleaning on stairs.

Do not use the appliance to vacuum flammable or combustible liquids, such as gasoline, or use in areas where they may be present.

This appliance is provided with double electrical insulation. Use only identical replacement parts. See instructions for servicing double-insulated appliances.

Do not vacuum anything that is burning or smoking, such as cigarettes, matches, or hot ashes.

Do not use the appliance without the vacuum bag or proper attachments in place.



# SAVE THESE INSTRUCTIONS

## Safety and Instructional Decals



Safety decals and instructions are easily visible to the operator and are located near any area of potential danger. Replace any decal that is damaged or missing.



125-0476

decal125-0476

## Setup

Register your product at [www.Toro.com](http://www.Toro.com) so that Toro can notify you in the case of a safety or warranty product recall.

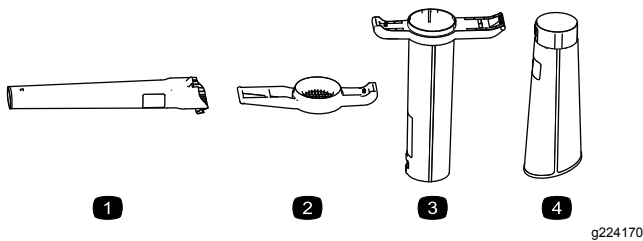

Figure 2

1. Blower tube
2. Bottom inlet cover
3. Upper-vacuum tube
4. Lower-vacuum tube

## Assembling the Blower

**Important:** The motor should not run unless the bottom inlet cover is locked in place.

**Note:** If the motor runs without the bottom inlet cover in place, do not use the appliance. Return it to an Authorized Service Dealer.

Install the blower tube and bottom inlet cover.

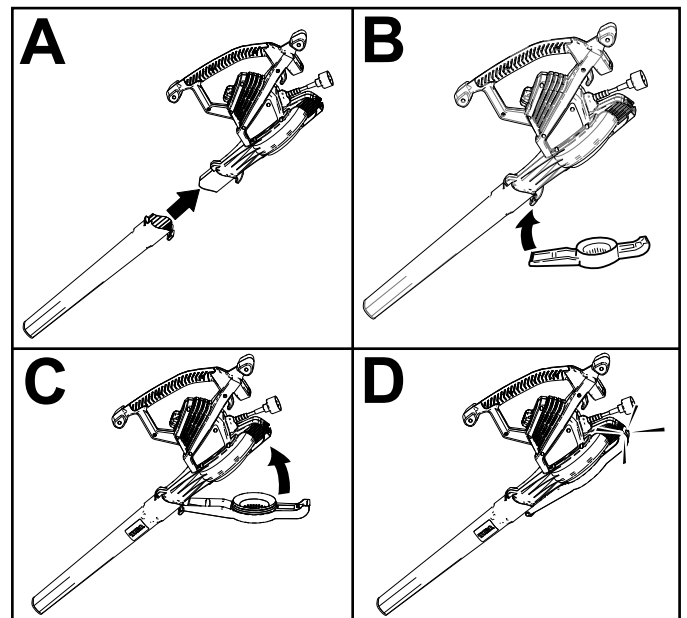

# Converting from Blower to Vacuum

## ⚠ WARNING

The impeller rotates for a few seconds after you turn off the appliance and can cut or injure fingers.

Do not remove the bottom inlet cover when the motor is running or when the appliance is plugged into a power outlet.

1. Remove the bottom inlet cover and the blower tube.

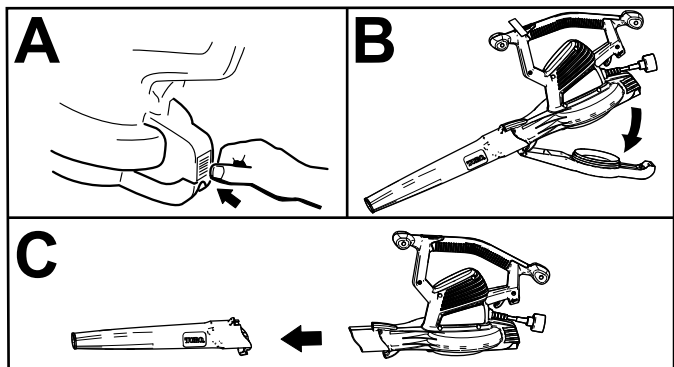

g227756

2. Install the vacuum tube and bag.

**Important:** The motor should not run unless the vacuum tube is locked in place.

**Note:** If the motor runs without the inlet cover in place, do not use the appliance. Return it to an Authorized Service Dealer.

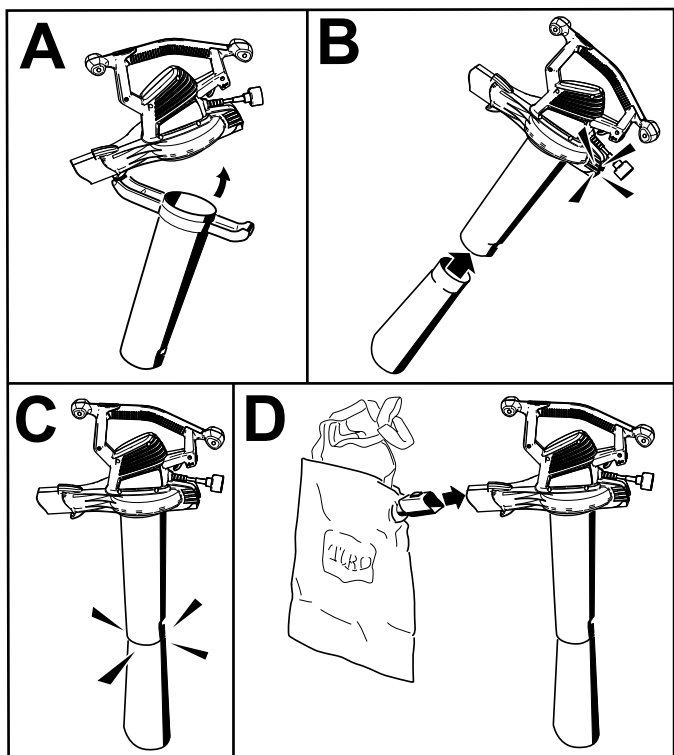

g227757

3. Adjust the bag strap as needed for comfortable operation.

# Converting from Vacuum to Blower

1. Remove the vacuum bag and the vacuum tube.

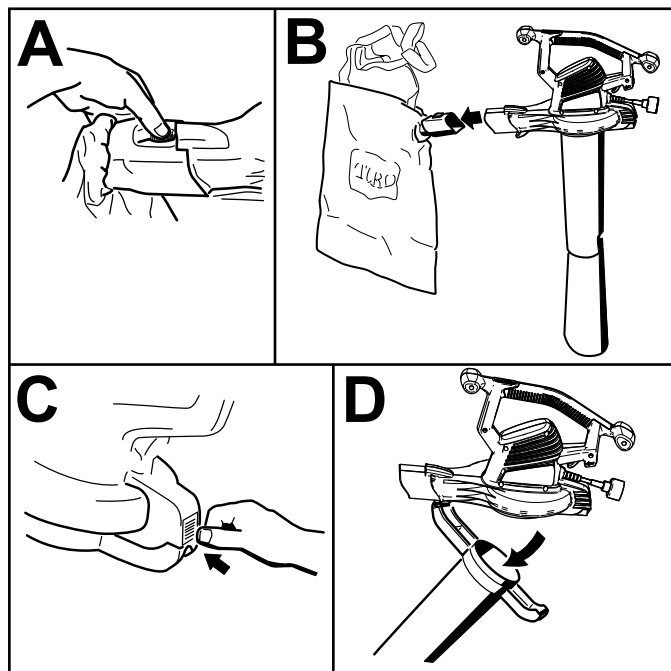

g227758

2. Install the blower tube and bottom inlet cover.

**Important:** The motor should not run unless the bottom inlet cover is locked in place.

**Note:** If the motor runs without the inlet cover in place, do not use the appliance. Return it to an Authorized Service Dealer.

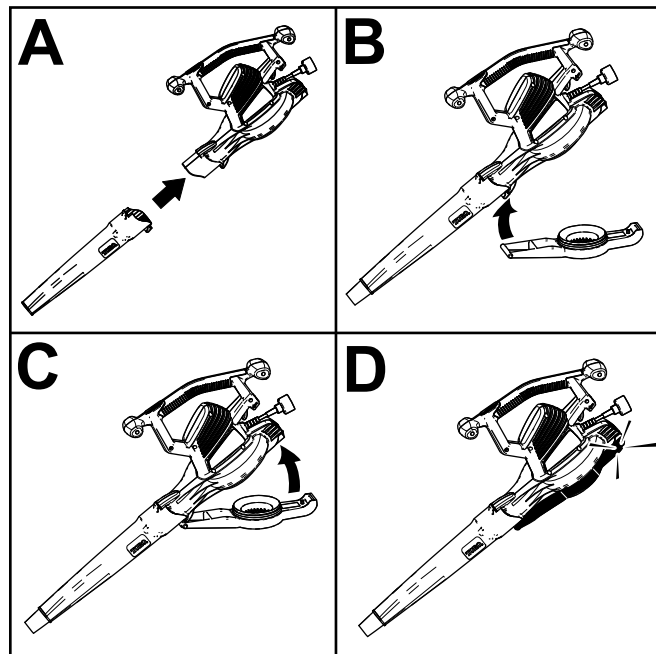

g227759

# Operation

**Important:** This appliance is intended for outdoor, residential use only. Do not use it indoors or for commercial or industrial purposes. This appliance is for household use only.

## Connecting to a Power Source

To reduce the risk of electric shock, this appliance has a polarized plug (i.e., one blade is wider than the other). Use only a polarized, UL listed (CSA certified in Canada) extension cord recommended for outdoor use. A polarized plug will fit in a polarized cord only one way. If the plug does not fit fully in the cord, reverse the cord. If it still does not fit, purchase a polarized extension cord. If you have a polarized extension cord and the extension cord plug does not fit fully into the wall receptacle, reverse the plug. If it still does not fit, contact a qualified electrician to install the proper outlet. Do not change the appliance or extension cord plug in any way.

Use only an extension cord recommended for outdoor use.

### **⚠ WARNING**

If you do not fully seat the extension cord on the inlet plug, or if the plug and cord do not fit firmly, the loose plug could lead to overheating and cause a fire, possibly burning you or others.

- Ensure that you fully seat the cord on the plug.
- Check the connection regularly to ensure that the cord is firmly attached.
- Do not use a worn-out or loose extension cord.

Extension Cord Length	Minimum Wire Gage (A.W.G.)
100 ft	14
150 ft	12

**Note:** Do not use an extension cord over 150 feet.

**Important:** Check the extension cord frequently during use for holes or cracks in the insulation. Do not use a damaged cord. Do not run the cord through standing water or wet grass.

Secure the extension cord to the appliance using the cord lock system as shown.

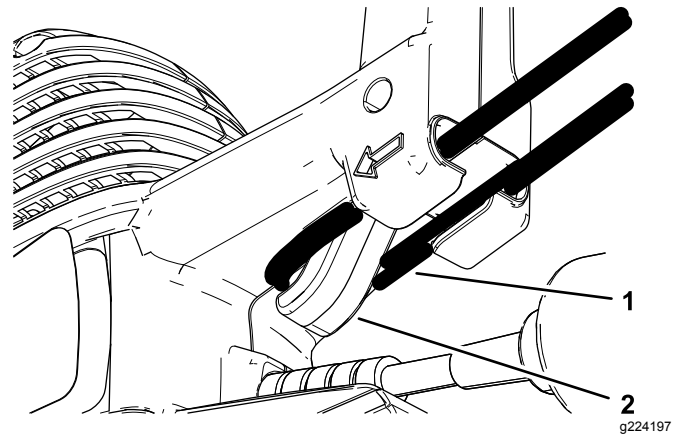

1. Extension cord      2. Cord lock

g224197

## Starting/Stopping/Adjusting the Air Speed

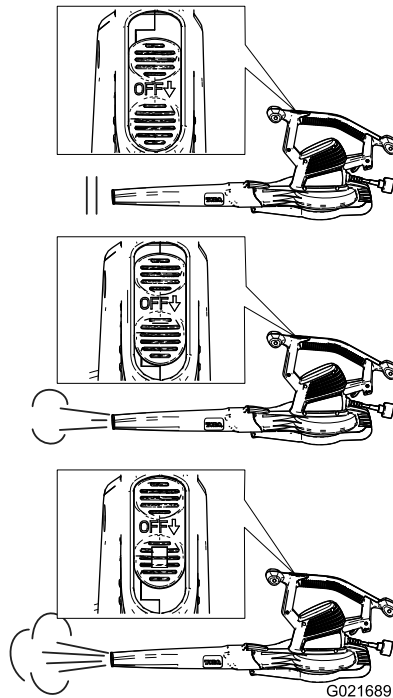

G021689

g021689

## Using the Nozzles

Install the concentrator nozzle into the blower tube to help reach into narrow spaces or to remove matted debris from hard surfaces.

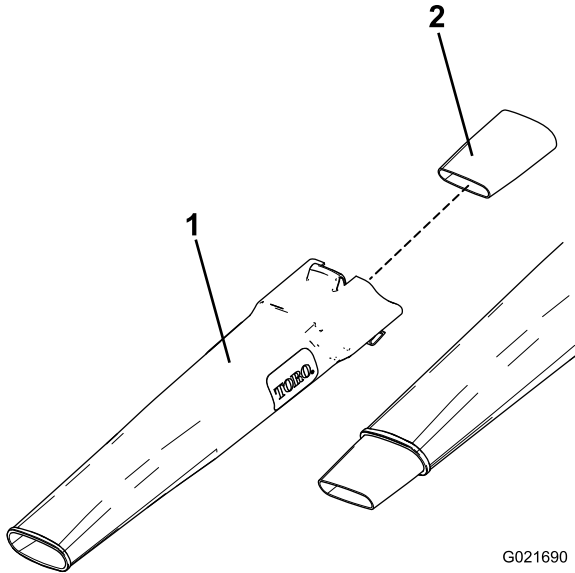

G021690

g021690

1. Blower tube

2. Concentrator nozzle

## Using the Appliance as a Blower

The appliance used as a blower is intended for residential use only. Use the blower outdoors to move debris as needed.

### ⚠ WARNING

Using the appliance as a blower can throw debris, possibly causing serious personal injury to you or bystanders.

- Do not blow hard objects such as nails, bolts, or rocks.
- Do not operate the blower near bystanders or pets.
- Use extra care when cleaning debris from stairs or other tight areas.
- Wear safety goggles or other suitable eye protection, long pants, and shoes.

## Using the Appliance as a Vacuum

Using the appliance as a vacuum is intended for residential use only. Use it outdoors to collect debris as needed.

### ⚠ WARNING

Using the appliance as a vacuum can throw debris, possibly causing serious personal injury to you or bystanders.

- Do not operate the vacuum without the bag installed or with the bag zipper open.
- Do not vacuum sharp, pointed, or hard objects that could be thrown through the fabric of the bag, such as wires, staples, nails, or rocks.



G017098

g017098

**Important:** Vacuum only leaves and soft items. Hard items such as sticks, rocks, acorns, and pine cones will damage the impeller.

**Important:** Do not force the vacuum tube into a pile of debris or hold the tube upright while force feeding debris into the tube. Either action may clog and damage the impeller. If the vacuum starts to vibrate or make abnormal noise, stop it, *unplug* the cord, and check for the cause.

## Emptying the Bag

1. Turn off and unplug the vacuum from the power source.
2. Empty any debris from the bag.



G017099

g017099

Do not store debris in the bag. To clean the bag, turn it inside out and shake out any excess debris. Once a year, hand wash the bag in soapy water and allow it to air dry.

## **⚠ DANGER**

Normal usage of the bag causes it to wear and deteriorate over time. A worn or deteriorated bag allows small objects to be thrown through the bag, possibly injuring you or bystanders.

Check the bag frequently. If it is worn or deteriorated, replace it with a genuine Toro vacuum bag.

## Separating the Vacuum Tube

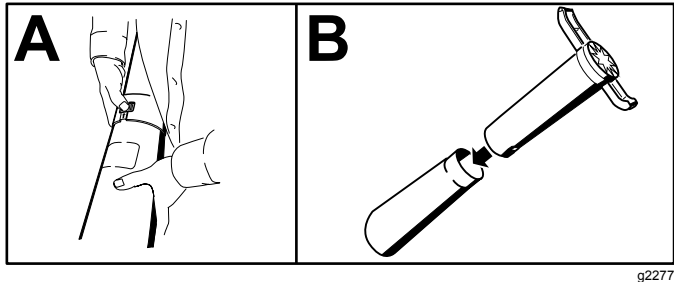

## Removing Clogged Debris from the Impeller

1. Turn off and **unplug** the appliance from the power source and wait for all moving parts to stop.
2. Remove the vacuum tube then remove the debris from impeller blades.

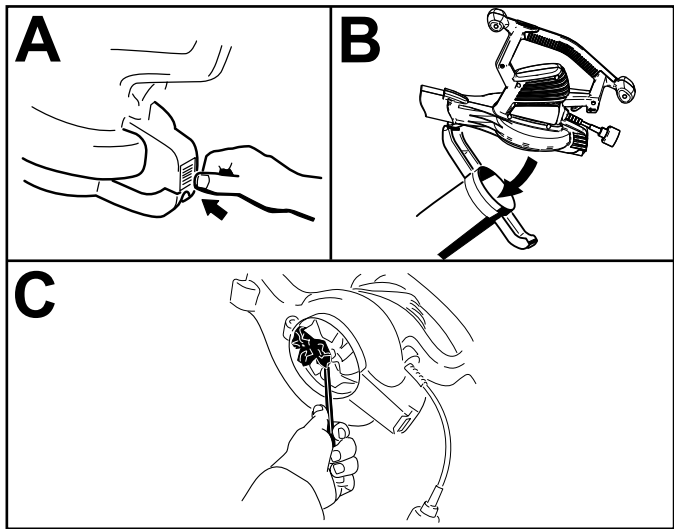

3. Check the impeller for any signs of damage. If it is damaged, contact your Authorized Service Dealer.
4. Install the vacuum tube, or, if you want to switch to blower mode, the bottom inlet cover. Refer to [Converting from Blower to Vacuum \(page 3\)](#) or [Converting from Vacuum to Blower \(page 3\)](#) for more information.

## Service

Toro has designed this product to give you years of trouble free use. Should it need service, bring the product to your Authorized Service Dealer. Your Toro Dealer is specially trained to repair Toro products and will ensure that your Toro stays "All" Toro.

## Double-insulated Appliances

In a double-insulated appliance, two systems of insulation are provided instead of grounding. No grounding means is provided on a double-insulated appliance, nor should a means for grounding be added to the appliance. Servicing a double-insulated appliance requires extreme care and knowledge of the system, and should be done only by the qualified service personnel at your Authorized Toro Service Dealer. Replacement parts for a double-insulated appliance must be identical to the parts they replace. A double-insulated appliance is marked with the words "Double Insulation" or "Double Insulated." The symbol (square within a square)  may also be marked on the appliance.

## Storage

Store the appliance and extension cord indoors, in a cool dry location, out of reach of children and animals.

## Troubleshooting

If your blower fails to run when you turn it on, check the following before contacting your Authorized Service Dealer:

- Ensure that the bottom inlet cover or vacuum tube is locked in place.
- Ensure that the power cord is secured in place at the back of the appliance and that the plug is fully seated.

# Notes:



**Count on it.**