



Anti-Scalp Kit
GrandStand® Mower
 Model No. 133-1440

Installation Instructions

⚠ WARNING

CALIFORNIA
Proposition 65 Warning

This product contains a chemical or chemicals known to the State of California to cause cancer, birth defects, or reproductive harm.

Preparing the Machine

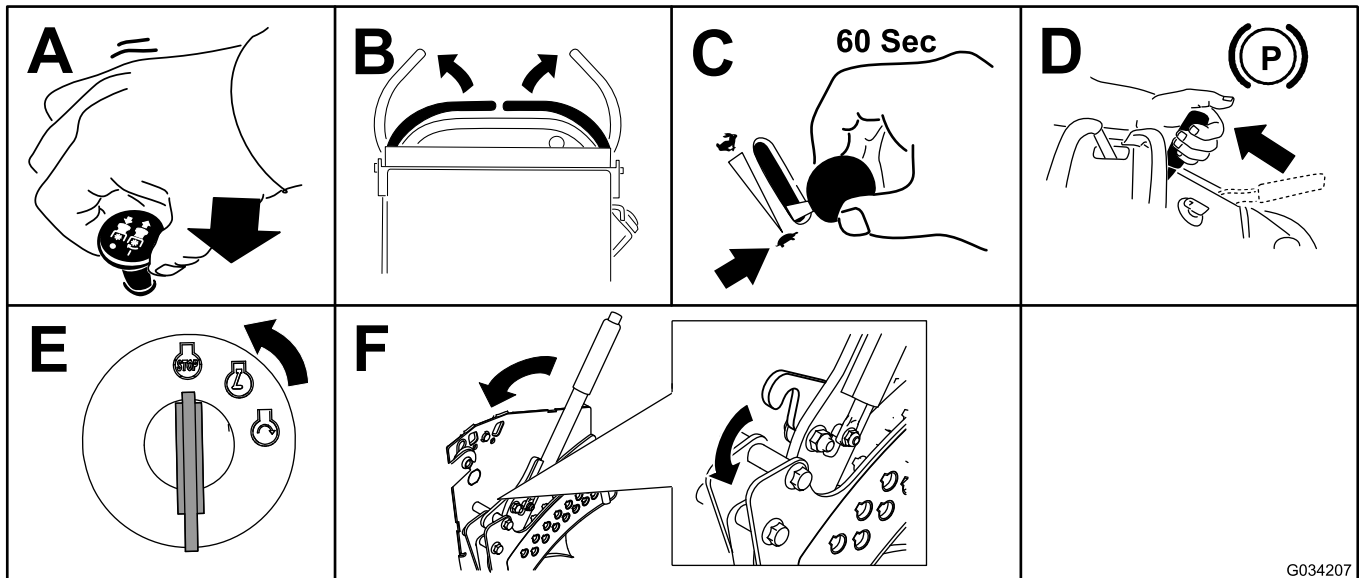

G034207



Installing the Rollers to the Brackets

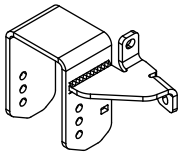

x1

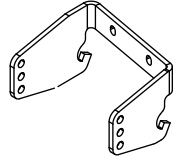

x1

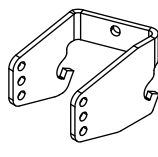

x1

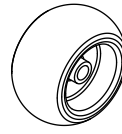

x4

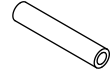

x2

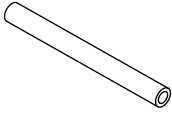

x1



x2

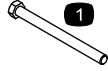

x2

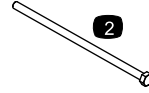

x1



x2



x1

G034208

1. 3/8 x 4-1/2 inches

2. 5/16 x 7-1/2 inches

3. 3/8 inch

4. 5/16 inch

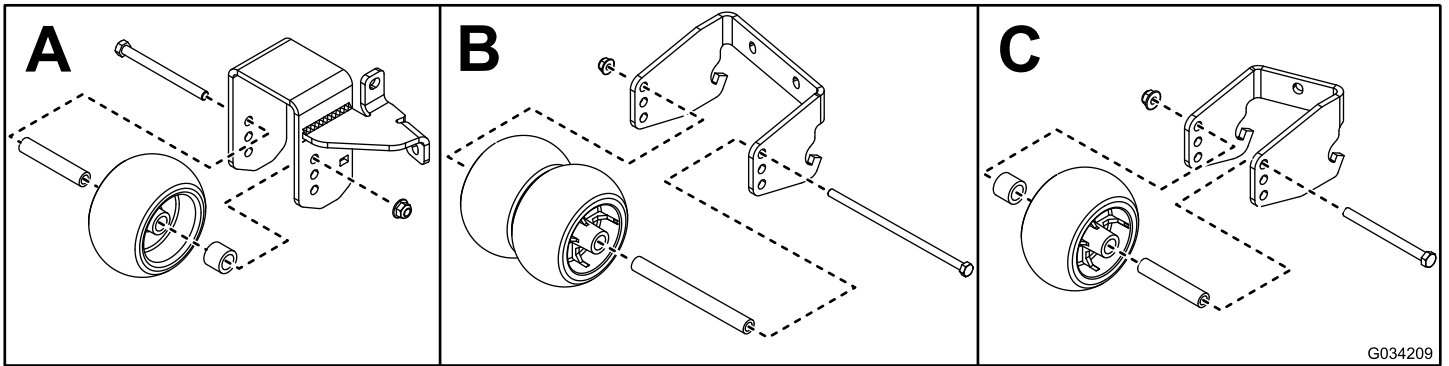

G034209

Installing the Brackets to the Deck

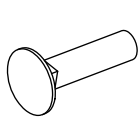

x1

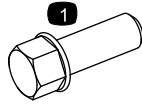

x1

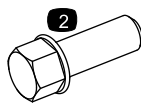

x4



x1



x1

G034210

1. 3/8 x 1-1/4 inches

2. 3/8 x 1 inch

3. 5/16 inch

4. 3/8 inch

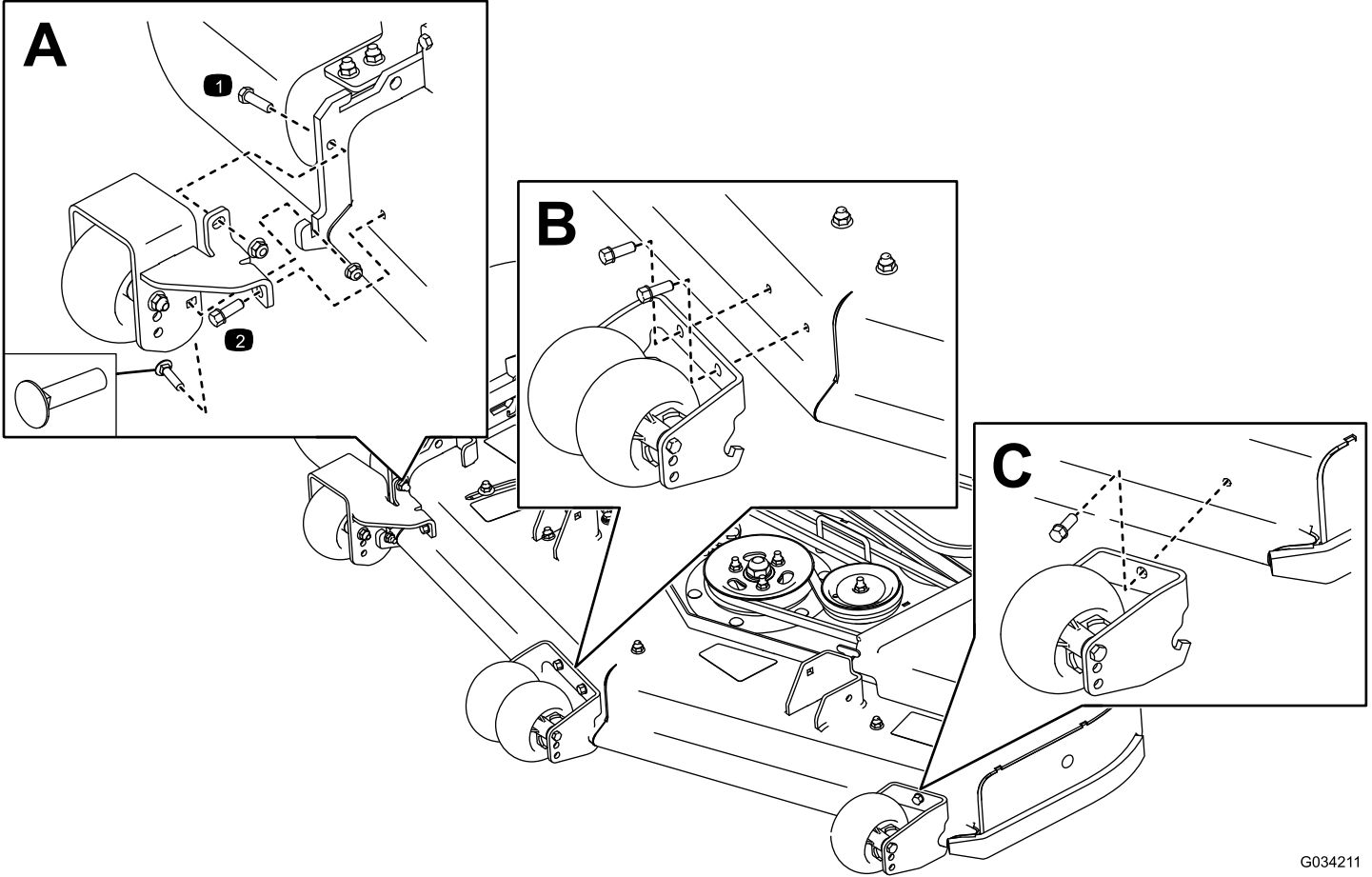

G034211



Count on it.